



acero inoxidable  
acier inoxydable  
stainless steel  
SERIE 304

botiquines  
kit de premier secours  
first-aid kit  
SERIE 130



SERIE 171

SERIE 223

SERIE 222

SERIE 161

armarios fitosanitarios  
armoires phytosanitaires  
phytosanitary cabinets

## INFORMACIÓN INFORMATION INFORMATION



Cierre centralizado.  
Verrouillage centralisé.  
Central locking.



Sistema antivuelco.  
Système anti-renversement.  
Anti-roll system.



Orificio para la extracción Ø75 mm.  
Orifice d'extraction Ø75 mm.  
Extraction hole Ø75 mm.



Bandeja zincada, orificio de ventilación.  
Bac zingué, orifice d'aération.  
Zinc-coated, holes of ventilation.

## ARMARIOS ALMACENAJE Y MODULARES ARMOIRES STOCKAGE ET MODULAIRES STORAGE AND MODULAR CABINETS

- [ES]**
  - Gran variedad de medidas y configuraciones.
  - Diseño robusto y resistente.
  - Alta resistencia de carga.
  - Varias configuraciones.
  - Apertura de puertas de 180 °.
  - Color estándar azul martelado posibilidad colores en opción. SERIE 170 (RAL 5017 - RAL 2009).
  - Armarios para el almacenaje y uso específico:
    - Fitosanitarios (RAL 6029, bandejas según normativa STAWA-R).
    - Botiquines (RAL 9016, según normativa).
- [FR]**
  - Grande variété de tailles et configurations.
  - Conception robuste et résistante.
  - Forte résistance au chargement.
  - Plusieurs configurations.
  - Ouverture des portes à 180 °.
  - Couleur standard bleu martelé possibilité teintes en option. SÉRIE 170 (RAL 5017 - RAL 2009).
  - Armoires pour le stockage de produits spécifiques:
    - Phytosanitaire. (RAL 6029, plateaux selon normative STAWA-R).
    - Soins de premier secours (RAL 9016).
- [EN]**
  - Wide range of sizes and configurations.
  - Strong and resistant design.
  - High weight-bearing resistance.
  - Several configurations.
  - 180 ° opening doors.
  - Standard colour hammered blue possibility optional colours. SERIE 170 (RAL 5017 - RAL 2009).
  - Storage cabinets for specific use:
    - Phytosanitary (RAL 6029, trays according to STAWA-R regulations).
    - First-aid kit (RAL 9016).

**SERIE 115 E**

Cierre centralizado.  
Verrouillage centralisé.  
Central locking.

Sistema antivuelco.  
Système anti-renversement.  
Anti-roll system.

Armarios con cajones y estanterías.  
Armoires avec tiroirs et étagères.  
Cabinets with drawers and shelves.

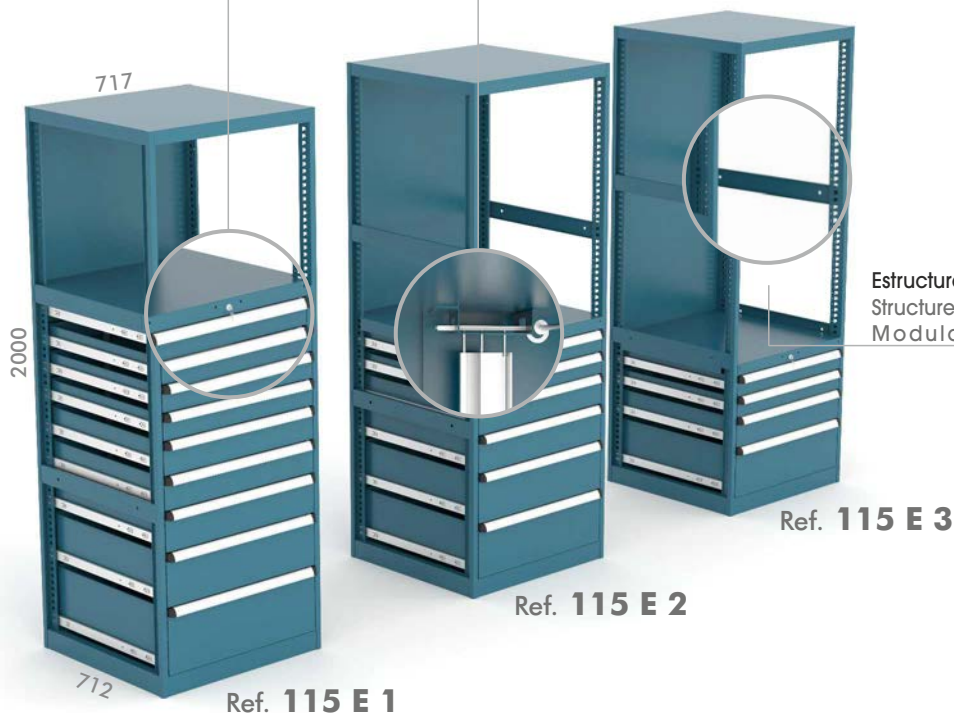

Estructura modular.  
Structure modulaire.  
Modular frame.

Accesorios opcionales  
Accessoires optionnels  
Optional accessories

Ref. 115 E 1 MC  
75 Kg

Ref. 115 E 2 MC  
75 Kg

Ref. 115 E 3 MC  
75 Kg

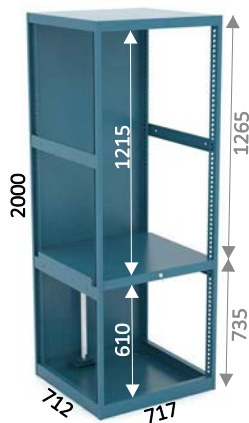
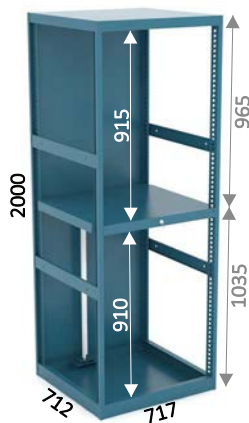
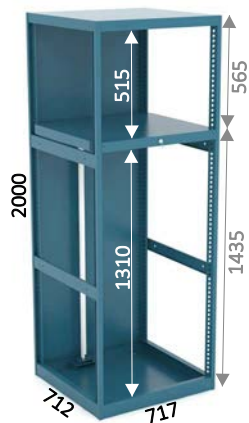

**e** 1 mm

**i** Plazo de entrega 10 días laborables.  
Délai de livraison 10 jours ouvrables.  
Delivery time 10 working days.

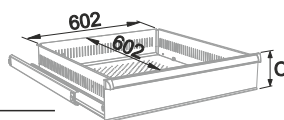

Cajones / Tiroirs / Drawers

Guías telescópicas.  
Glissières télescopiques.  
Telescopic slides.



**GT** Apertura 100%.  
Ouverture 100%.  
100% opening.

**i** Los cajones no incluyen divisiones.  
Le tiroirs non inclus les séparations.  
Divisions non included at drawers.

SERIE 115	C=50	●	115 T100 C50	10,5Kg
	C=75	●	115 T100 C75	11Kg
	C=100	●	115 T100 C100	12,5Kg
	C=125	●	115 T100 C125	13Kg
	C=150	●	115 T100 C150	13,5Kg
	C=200	●	115 T100 C200	14,5Kg
	C=250	●	115 T100 C250	15,5Kg
	C=300	●		
<b>e</b> 1.5 mm				

- Ref. 115 E 1 P **KG** 5,5 Kg **H** 535
- Ref. 115 E 2 P **KG** 7,3 Kg **H** 935
- Ref. 115 E 3 P **KG** 8,6 Kg **H** 1235
- Ref. 115 E P **KG** 9,9 Kg **H** 1915

Ref. 115 E L  
**KG** 13 Kg  
Lateral  
Latéral  
Latéral

Ref. 115 EG  
**KG** 8 Kg  
Estantería graduable  
Étagère réglable  
Adjustable shelf

Ref. CE P 1



Cierre electrónico  
Verrou électronique  
Electronic locking  
Ref. CE P 1 - Ref. CE P 1 TM -  
Ref. CE P 1 TU

Gama de producto  
Gamme de produits  
Product range

## Ref. 115 E 1



## Ref. 115 E 1 4 11

 174,5 Kg  
1u. 115 T100 C100  
6u. 115 T100 C200

## Ref. 115 E 1 4 14

 185 Kg  
1u. 115 T100 C75  
2u. 115 T100 C200  
1u. 115 T100 C125  
2u. 115 T100 C200  
2u. 115 T100 C250

## Ref. 115 E 1 4 17

 208,5 Kg  
8u. 115 T100 C75  
1u. 115 T100 C200  
2u. 115 T100 C250

## Ref. 115 E 1 4 12

 172,5 Kg  
2u. 115 T100 C150  
5u. 115 T100 C200

## Ref. 115 E 1 4 15

 202 Kg  
4u. 115 T100 C75  
1u. 115 T100 C100  
2u. 115 T100 C125  
2u. 115 T100 C200  
1u. 115 T100 C250

## Ref. 115 E 1 4 18

 220 Kg  
7u. 115 T100 C75  
3u. 115 T100 C125  
1u. 115 T100 C150  
1u. 115 T100 C250

## Ref. 115 E 1 4 13

 185 Kg  
4u. 115 T100 C100  
2u. 115 T100 C200  
2u. 115 T100 C250

## Ref. 115 E 1 4 16

 191 Kg  
2u. 115 T100 C75  
3u. 115 T100 C100  
2u. 115 T100 C125  
1u. 115 T100 C150  
1u. 115 T100 C200  
1u. 115 T100 C250

## Ref. 115 E 1 4 19

 237 Kg  
13u. 115 T100 C100

## Ref. 115 E 2



## Ref. 115 E 2 2 11

 134 Kg  
1u. 115 T100 C100  
4u. 115 T100 C200

## Ref. 115 E 2 2 14

 163,5 Kg  
3u. 115 T100 C75  
1u. 115 T100 C100  
1u. 115 T100 C125  
1u. 115 T100 C200  
1u. 115 T100 C250

## Ref. 115 E 2 2 17

 187,5 Kg  
9u. 115 T100 C100

## Ref. 115 E 2 2 12

 155 Kg  
1u. 115 T100 C75  
1u. 115 T100 C100  
1u. 115 T100 C125  
1u. 115 T100 C150  
1u. 115 T100 C200  
1u. 115 T100 C250

## Ref. 115 E 2 2 15

 175 Kg  
2u. 115 T100 C75  
2u. 115 T100 C100  
2u. 115 T100 C125  
2u. 115 T100 C150

## Ref. 115 E 2 2 18

 200,5 Kg  
8u. 115 T100 C75  
3u. 115 T100 C100

## Ref. 115 E 2 2 13

 156 Kg  
6u. 115 T100 C150

## Ref. 115 E 2 2 16

 184,5 Kg  
3u. 115 T100 C75  
4u. 115 T100 C100  
1u. 115 T100 C125  
1u. 115 T100 C150

## Ref. 115 E 2 2 19

 207 Kg  
12u. 115 T100 C75

## Ref. 115 E 3



## Ref. 115 E 3 1 11

 118 Kg  
1u. 115 T100 C150  
1u. 115 T100 C200  
1u. 115 T100 C250

## Ref. 115 E 3 1 14

 127 Kg  
2u. 115 T100 C75  
1u. 115 T100 C200  
1u. 115 T100 C250

## Ref. 115 E 3 1 17

 138,5 Kg  
1u. 115 T100 C75  
2u. 115 T100 C100  
1u. 115 T100 C125  
1u. 115 T100 C200

## Ref. 115 E 3 1 12

 129 Kg  
2u. 115 T100 C100  
2u. 115 T100 C200

## Ref. 115 E 3 1 15

 128 Kg  
2u. 115 T100 C100  
1u. 115 T100 C150  
1u. 115 T100 C250

## Ref. 115 E 3 1 18

 150 Kg  
6u. 115 T100 C100

## Ref. 115 E 3 1 13

 129 Kg  
4u. 115 T100 C150

## Ref. 115 E 3 1 16

 137,5 Kg  
2u. 115 T100 C75  
1u. 115 T100 C100  
1u. 115 T100 C150  
1u. 115 T100 C200

## Ref. 115 E 3 1 19

 141 Kg  
8u. 115 T100 C75

**SERIE 119 E**

Cierre centralizado.  
Verrouillage centralisé.  
Central locking.

Sistema antivuelco.  
Système anti-renversement.  
Anti-roll system.

Armarios con cajones y estanterías.  
Armoires avec tiroirs et étagères.  
Cabinets with drawers and shelves.

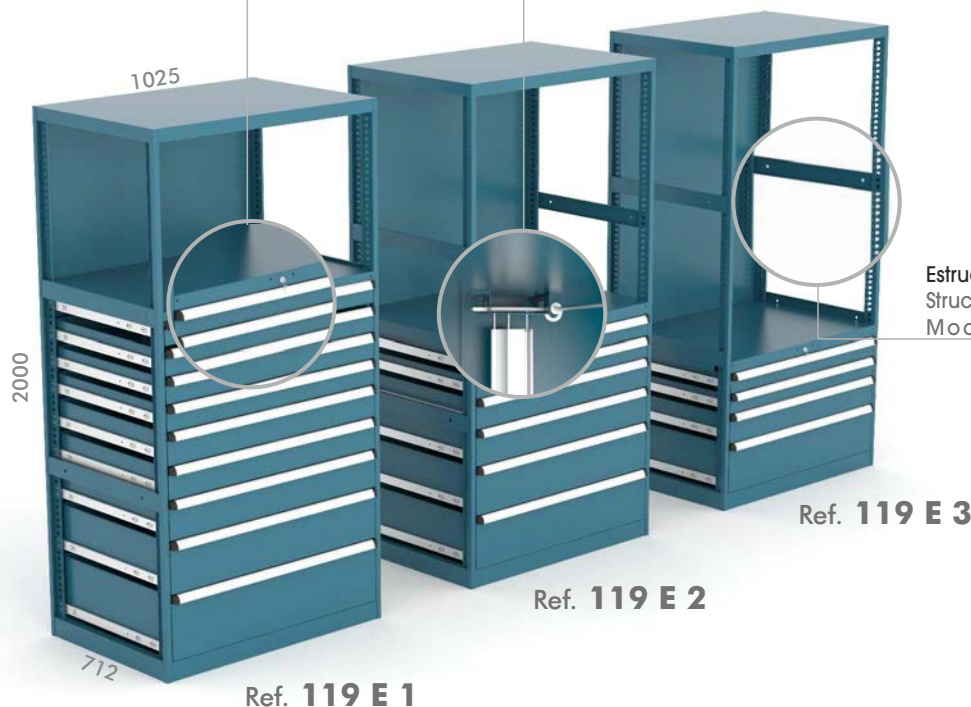

Estructura modular.  
Structure modulaire.  
Modular frame.

Accesorios opcionales  
Accessoires optionnels  
Optional accessories

Ref. 119 E 1 MC  
KG 112 Kg

Ref. 119 E 2 MC  
KG 112 Kg

Ref. 119 E 3 MC  
KG 112 Kg

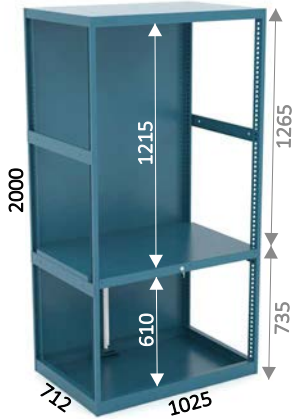
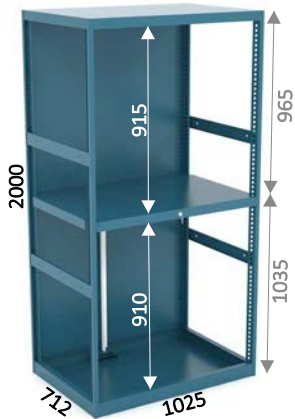
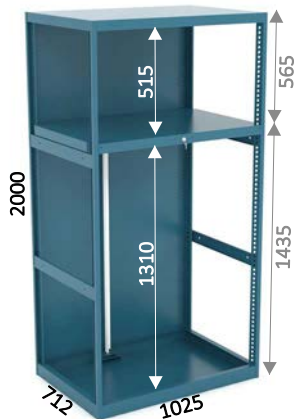

- Ref. 119 E 1 P 1  
KG 8,4 Kg H 535
- Ref. 119 E 2 P 2  
KG 10,7 Kg H 935
- Ref. 119 E 3 P 3  
KG 12,5 Kg H 1235
- Ref. 119 E P  
KG 14,3 Kg H 1915

Ref. 115 E L  
KG 13 Kg  
Lateral  
Latéral  
Lateral



Ref. 119 EG  
KG 10 Kg  
Estantería graduable  
Étagère réglable  
Adjustable shelf

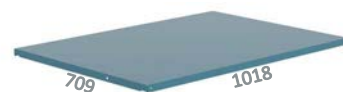

Ref. CE P 1

Cierre electrónico  
Verrou électronique  
Electronic locking  
Ref. CE P 1 - Ref. CE P 1 TM -  
Ref. CE P 1 TU

**e** 1 mm

**i** Plazo de entrega 10 días laborables.  
Délai de livraison 10 jours ouvrables.  
Delivery time 10 working days.

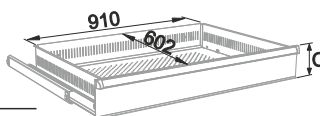

Cajones / Tiroirs / Drawers

Guías telescópicas.  
Glissières télescopiques.  
Telescopic slides.



GT Apertura 100%.  
Ouverture 100%.  
100% opening.

**i** Los cajones no incluyen divisiones.  
Les tiroirs non inclus les séparations.  
Divisions non included at drawers.

		GT	100 KG	
SERIE 119	C=50	●	119 T100 C75	15,5Kg
	C=75	●	119 T100 C100	16,5Kg
	C=100	●	119 T100 C125	17,5Kg
	C=125	●	119 T100 C150	18,5Kg
	C=150	●	119 T100 C200	19Kg
	C=200	●	119 T100 C250	20Kg
	C=250	●	119 T100 C250	22,5Kg
	C=300			
		<b>e</b>	1.5 mm	

Gama de producto  
Gamme de produits  
Product range

## Ref. 119 E 1



## Ref. 119 E 1 4 11

 249,5 Kg  
1u. 119 T100 C100  
6u. 119 T100 C200

## Ref. 119 E 1 4 14

 267 Kg  
1u. 119 T100 C75  
2u. 119 T100 C200  
1u. 119 T100 C125  
2u. 119 T100 C200  
2u. 119 T100 C250

## Ref. 119 E 1 4 17

 309 Kg  
8u. 119 T100 C75  
1u. 119 T100 C200  
2u. 119 T100 C250

## Ref. 119 E 1 4 12

 295 Kg  
2u. 119 T100 C150  
5u. 119 T100 C200

## Ref. 119 E 1 4 15

 295 Kg  
4u. 119 T100 C75  
1u. 119 T100 C100  
2u. 119 T100 C125  
2u. 119 T100 C200  
1u. 119 T100 C250

## Ref. 119 E 1 4 18

 324,5 Kg  
7u. 119 T100 C75  
3u. 119 T100 C125  
1u. 119 T100 C150  
1u. 119 T100 C250

## Ref. 119 E 1 4 13

 262 Kg  
4u. 119 T100 C100  
2u. 119 T100 C200  
2u. 119 T100 C250

## Ref. 119 E 1 4 16

 278,5 Kg  
2u. 119 T100 C75  
3u. 119 T100 C100  
2u. 119 T100 C125  
1u. 119 T100 C150  
1u. 119 T100 C200  
1u. 119 T100 C250

## Ref. 119 E 1 4 19

 339,5 Kg  
13u. 119 T100 C100

## Ref. 119 E 2



## Ref. 119 E 2 2 11

 215 Kg  
1u. 119 T100 C100  
4u. 119 T100 C200

## Ref. 119 E 2 2 14

 240 Kg  
3u. 119 T100 C75  
1u. 119 T100 C100  
1u. 119 T100 C125  
1u. 119 T100 C200  
1u. 119 T100 C250

## Ref. 119 E 2 2 17

 269,5 Kg  
9u. 119 T100 C100

## Ref. 119 E 2 2 12

 226 Kg  
1u. 119 T100 C75  
1u. 119 T100 C100  
1u. 119 T100 C125  
1u. 119 T100 C150  
1u. 119 T100 C200  
1u. 119 T100 C250

## Ref. 119 E 2 2 15

 255 Kg  
2u. 119 T100 C75  
2u. 119 T100 C100  
2u. 119 T100 C125  
2u. 119 T100 C150

## Ref. 119 E 2 2 18

 296,5 Kg  
8u. 119 T100 C75  
3u. 119 T100 C100

## Ref. 119 E 2 2 13

 226 Kg  
6u. 119 T100 C150

## Ref. 119 E 2 2 16

 269 Kg  
3u. 119 T100 C75  
4u. 119 T100 C100  
1u. 119 T100 C125  
1u. 119 T100 C150

## Ref. 119 E 2 2 19

 310 Kg  
12u. 119 T100 C75

## Ref. 119 E 3



## Ref. 119 E 3 1 11

 173,5 Kg  
1u. 119 T100 C150  
1u. 119 T100 C200  
1u. 119 T100 C250

## Ref. 119 E 3 1 14

 187,5 Kg  
2u. 119 T100 C75  
1u. 119 T100 C200  
1u. 119 T100 C250

## Ref. 119 E 3 1 17

 202 Kg  
1u. 119 T100 C75  
2u. 119 T100 C100  
1u. 119 T100 C125  
1u. 119 T100 C200

## Ref. 119 E 3 1 12

 187 Kg  
2u. 119 T100 C100  
2u. 119 T100 C200

## Ref. 119 E 3 1 15

 188,5 Kg  
2u. 119 T100 C100  
1u. 119 T100 C150  
1u. 119 T100 C250

## Ref. 119 E 3 1 18

 217 Kg  
6u. 119 T100 C100

## Ref. 119 E 3 1 13

 188 Kg  
4u. 119 T100 C150

## Ref. 119 E 3 1 16

 201 Kg  
2u. 119 T100 C75  
1u. 119 T100 C100  
1u. 119 T100 C150  
1u. 119 T100 C200

## Ref. 119 E 3 1 19

 244 Kg  
8u. 119 T100 C75

## SERIE 119 E P C

Cierre centralizado.  
Verrouillage centralisé.  
Central locking.



Armarios con cajones y estanterías (cierre con persiana).  
Armoires avec tiroirs et étagères (fermeture avec rideau).  
Cabinets with drawers and shelves (shutter closing).

### Ref. 119 E P C

 160 Kg



Sistema antivuelco.  
Système anti-renversement.  
Roll-over protection system.

### Accesorios opcionales Accessoires optionnels Optional accessories

#### Ref. 119 EGP

 10 Kg

Estantería graduable  
Étagère réglable  
Adjustable shelf



#### Ref. CE P 1



Cierre electrónico  
Verrou électronique  
Electronic locking  
Ref. CE P 1 - Ref. CE P 1 TM -  
Ref. CE P 1 TU

 1 mm

 Plazo de entrega 10 días laborables.  
Délai de livraison 10 jours ouvrables.  
Delivery time 10 working days.

### Cajones / Tiroirs / Drawers

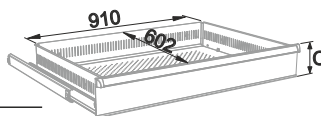



Guías telescópicas.  
Glissières télescopiques.  
Telescopic slides.

 Apertura 100%.  
Ouverture 100%.  
100% opening.



Los cajones no incluyen divisiones.  
Le tiroirs non inclus les séparations.  
Divisions non included at drawers.

 1.5 mm

SERIE 119	C=50	●	119 T100 C75	15,5Kg	GT 100	
						
	C=75	●	119 T100 C100	16,5Kg		
	C=100	●	119 T100 C125	17,5Kg		
	C=125	●	119 T100 C150	18,5Kg		
	C=150	●	119 T100 C200	19Kg		
	C=200	●	119 T100 C250	20Kg		
	C=250	●	119 T100 C250	22,5Kg		
	C=300					

### Gama de producto Gamme de produits Product range

#### Ref. 119 E P C 2 11

 251 Kg

1u. 119 T100 C100  
4u. 119 T100 C200

#### Ref. 119 E P C 2 12

 262 Kg

1u. 119 T100 C75  
1u. 119 T100 C100  
1u. 119 T100 C125  
1u. 119 T100 C150  
1u. 119 T100 C200  
1u. 119 T100 C250

#### Ref. 119 E P C 2 13

 262 Kg

6u. 119 T100 C150

#### Ref. 119 E P C 2 14

 276 Kg

3u. 119 T100 C75  
1u. 119 T100 C100  
1u. 119 T100 C125  
1u. 119 T100 C200  
1u. 119 T100 C250

#### Ref. 119 E P C 2 15

 291 Kg

2u. 119 T100 C75  
2u. 119 T100 C100  
2u. 119 T100 C125  
2u. 119 T100 C150

#### Ref. 119 E P C 2 16

 305 Kg

3u. 119 T100 C75  
4u. 119 T100 C100  
1u. 119 T100 C125  
1u. 119 T100 C150

#### Ref. 119 E P C 2 17

 305,5 Kg

9u. 119 T100 C100

#### Ref. 119 E P C 2 18

 305,5 Kg

8u. 119 T100 C75  
3u. 119 T100 C100

#### Ref. 119 E P C 2 19

 346 Kg

12u. 119 T100 C75

SERIE 127

Armario con puertas y cajones.  
Armoire avec portes et tiroirs.  
Cabinets with doors and drawers.



Cajones  
Tiroirs  
Drawers

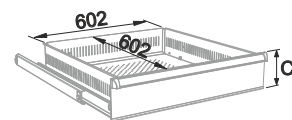

SERIE 115		
GT		100 Kg
C=50	● 115 T100 C50	10,5Kg
C=75	● 115 T100 C75	11Kg
C=100	● 115 T100 C100	12,5Kg
C=125	● 115 T100 C125	13Kg
C=150	● 115 T100 C150	13,5Kg
C=200	● 115 T100 C200	14,5Kg
C=250	● 115 T100 C250	15,5Kg
C=300		
		e 1.5 mm



Guías telescópicas.  
Glissières télescopiques.  
Telescopic slides.

GT Apertura 100%.  
Ouverture 100%.  
100% opening.

e 1 mm

Plazo de entrega 10 días laborables.  
Delai de livraison 10 jours ouvrables.  
Delivery time 10 working days.

No incluyen divisiones.  
Non inclus les séparations.  
Divisions non included.

Ref. 127 3  
77,5 Kg

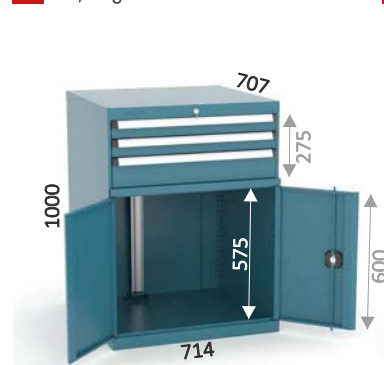

Ref. 127 4  
109 Kg

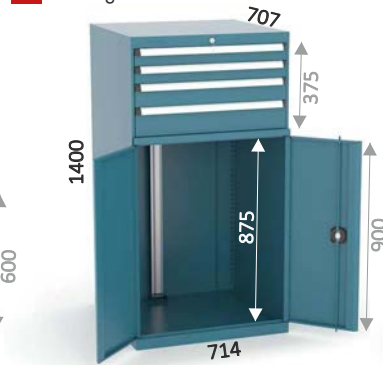

Ref. 127 5  
96,5 Kg



Ref. 127 6  
112 Kg



Accesorios opcionales  
Accessoires optionnels  
Optional accessories

Ref. 127 BG  
4 Kg

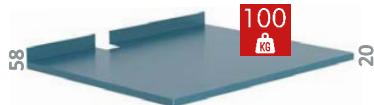

Ref. 127 BE T100  
5 Kg



Ref. 127 BE T200  
5,25 Kg

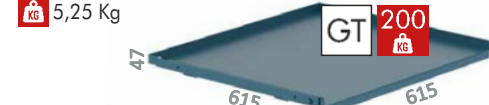

Ref. T200 50  
25 Porta Conos ISO 50  
25 Porte-Cônes ISO 50  
25 Tool-Holder ISO 50

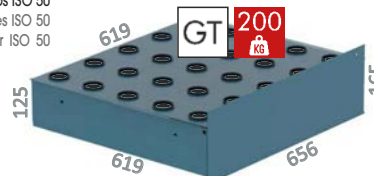

Ref. 127 T200 40  
25 Porta Conos ISO 40  
25 Porte-Cônes ISO 40  
25 Tool-Holder ISO 40

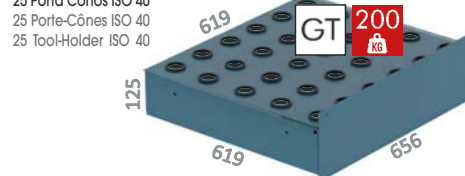

Ref. 127 T100 300

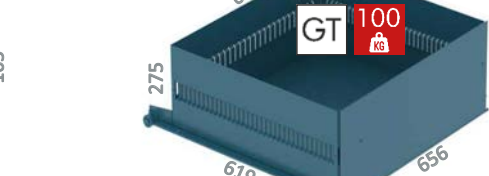

## SERIE 127

Gama de producto  
Gamme de produits  
Product range

Ref. 127 3

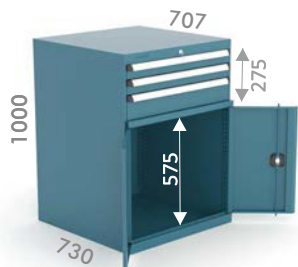

Ref. 127 3 1

 77,5 Kg  
2u. 115 T100 C75  
1u. 115 T100 C125  
2u. 127 BG

Ref. 127 3 2

 87,5 Kg  
2u. 115 T100 C75  
1u. 115 T100 C125  
2u. 127 BE T100

Ref. 127 3 3

 104 Kg  
2u. 115 T100 C75  
1u. 115 T100 C125  
1u. 127 BG  
1u. 127 T100 300

Ref. 127 3 4

 112,5 Kg  
2u. 115 T100 C75  
1u. 115 T100 C125  
1u. 127 BE T100  
1u. 127 T100 300

Ref. 127 3 5

 140,5 Kg  
2u. 115 T100 C75  
1u. 115 T100 C125  
1u. 127 BE T100  
1u. 127 T200 40

Ref. 127 3 6

 123,5 Kg  
2u. 115 T100 C75  
1u. 115 T100 C125  
1u. 127 T200 40  
1u. 127 T200 50

Ref. 127 4

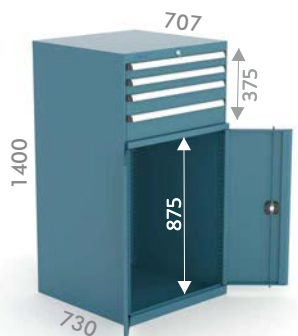

Ref. 127 4 1

 97,5 Kg  
2u. 115 T100 C75  
1u. 115 T100 C100  
1u. 115 T100 C125  
2u. 127 BG

Ref. 127 4 2

 114,5 Kg  
2u. 115 T100 C75  
1u. 115 T100 C100  
1u. 115 T100 C125  
2u. 127 BE T100

Ref. 127 4 3

 146 Kg  
2u. 115 T100 C75  
1u. 115 T100 C100  
1u. 115 T100 C125  
1u. 127 BG  
2u. 127 T100 300

Ref. 127 4 4

 129,5 Kg  
2u. 115 T100 C75  
1u. 115 T100 C100  
1u. 115 T100 C125  
1u. 127 BE T100  
1u. 127 T100 300

Ref. 127 4 5

 127,5 Kg  
2u. 115 T100 C75  
1u. 115 T100 C100  
1u. 115 T100 C125  
1u. 127 BE T100  
1u. 127 T200 50

Ref. 127 4 6

 147,5 Kg  
2u. 115 T100 C75  
1u. 115 T100 C100  
1u. 115 T100 C125  
1u. 127 T200 40  
1u. 127 T200 50

Ref. 127 5



Ref. 127 5 1

 112 Kg  
1u. 115 T100 C75  
2u. 115 T100 C100  
1u. 115 T100 C125  
1u. 115 T100 C200  
2u. 127 BG

Ref. 127 5 2

 129 Kg  
1u. 115 T100 C75  
2u. 115 T100 C100  
1u. 115 T100 C125  
1u. 115 T100 C200  
2u. 127 BE T100

Ref. 127 5 3

 135,5 Kg  
1u. 115 T100 C75  
2u. 115 T100 C100  
1u. 115 T100 C125  
1u. 115 T100 C200  
1u. 127 BG  
1u. 115 T100 300

Ref. 127 5 4

 144 Kg  
1u. 115 T100 C75  
2u. 115 T100 C100  
1u. 115 T100 C125  
1u. 115 T100 C200  
1u. 127 BE T100  
1u. 127 T100 300

Ref. 127 5 5

 145,5 Kg  
1u. 115 T100 C75  
2u. 115 T100 C100  
1u. 115 T100 C125  
1u. 115 T100 C200  
1u. 127 BE T100  
1u. 127 T200 50

Ref. 127 5 6

 162 Kg  
1u. 115 T100 C75  
2u. 115 T100 C100  
1u. 115 T100 C150  
1u. 115 T100 C200  
1u. 127 T200 40  
1u. 127 T200 50

Ref. 127 6

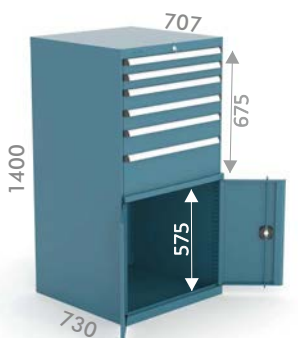

Ref. 127 6 1

 121 Kg  
2u. 115 T100 C75  
2u. 115 T100 C100  
1u. 115 T100 C125  
1u. 115 T100 C200  
2u. 127 BG

Ref. 127 6 2

 138 Kg  
2u. 115 T100 C75  
2u. 115 T100 C100  
1u. 115 T100 C125  
1u. 115 T100 C200  
2u. 127 BE T100

Ref. 127 6 3

 144,5 Kg  
2u. 115 T100 C75  
2u. 115 T100 C100  
1u. 115 T100 C125  
1u. 115 T100 C200  
1u. 127 BG  
1u. 127 T100 300

Ref. 127 6 4

 153 Kg  
2u. 115 T100 C75  
2u. 115 T100 C100  
1u. 115 T100 C125  
1u. 115 T100 C200  
1u. 127 BE T100  
1u. 127 T200 300

Ref. 127 6 5

 154,5 Kg  
2u. 115 T100 C75  
2u. 115 T100 C100  
1u. 115 T100 C125  
1u. 115 T100 C200  
1u. 127 BE T100  
1u. 127 T200 50

Ref. 127 6 6

 171 Kg  
2u. 115 T100 C75  
2u. 115 T100 C100  
1u. 115 T100 C125  
1u. 115 T100 C200  
1u. 127 T200 40  
1u. 127 T200 50

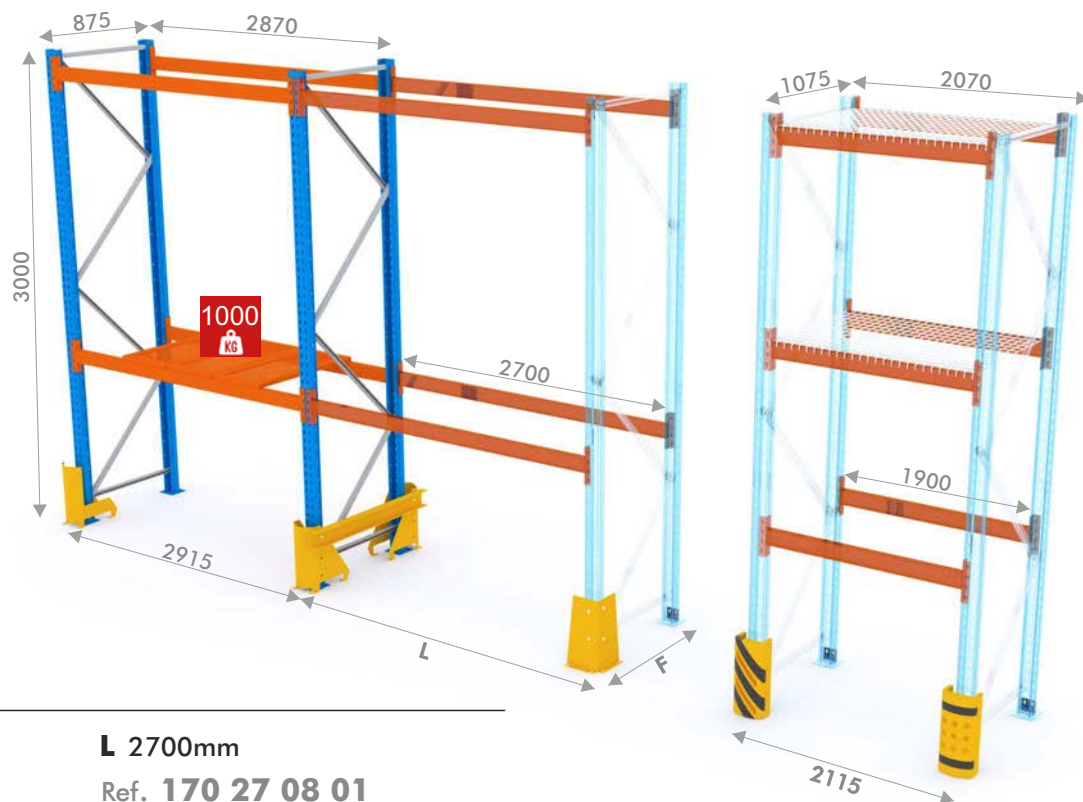

Gama de producto  
Gamme de produits  
Product range

**L 1900mm**

Ref. **170 19 08 01**  
 105 Kg      **F 800mm**  
 2u. Ref. 170 L 19

Ref. **170 19 08 02**  
 75 Kg      Módulos adicionales.  
 Módulos additionnels./Additional modules.  
 2u. Ref. 170 L 19

Ref. **170 19 10 01**  
 106 Kg      **F 1000mm**  
 2u. Ref. 170 L 19

Ref. **170 19 10 02**  
 77 Kg      Módulos adicionales.  
 Módulos additionnels./Additional modules.  
 2u. Ref. 170 L 19

**L 2700mm**

Ref. **170 27 08 01**  
 117 Kg      **F 800mm**  
 2u. Ref. 170 L 27

Ref. **170 27 08 02**  
 87 Kg      Módulos adicionales.  
 Módulos additionnels./Additional modules.  
 2u. Ref. 170 L 27

Ref. **170 27 10 01**  
 121 Kg      **F 1000mm**  
 2u. Ref. 170 L 27

Ref. **170 27 10 02**  
 89 Kg      Módulos adicionales.  
 Módulos additionnels./Additional modules.  
 2u. Ref. 170 L 27

HOMOLOGACIÓN HOMOLOGATION

EQUIPOS DE ALMACENAJE - UNE 58014.  
 ÉQUIPEMENTS DE STOCKAGE - UNE 58014.  
 STORAGE EQUIPMENT - UNE 58014.

Anclaje al suelo M12 (no incluido).  
 Fixation au sol M12 (non inclus).  
 Floor fixing M12 (not included).

Colores estándar.  
 Couleurs Standard.  
 Standard colours.      RAL 5017 / RAL 2009

Las patas laterales se sirven montadas.  
 Les pattes latérales sont servis montés.  
 Side covers are delivered assembled.

Accesorios  
Accessoires  
Accessories



Ref. **170 L 19**      Ref. **170 L 27**  
 Juego de dos      Juego de dos  
 Un jeu de deux      Un jeu de deux  
 Two units      Two units  
 25 Kg      27 Kg  
**L 1900mm**      **L 2700mm**

Ref. **170 BG 08**  
 Estantería  
 Étagère  
 Shelf  
 5,23 Kg  
**F 800mm**

Ref. **170 M 30**  
 Juego de dos  
 Un jeu de deux  
 Two units  
 23 Kg

Ref. **170 BASE**  
 Juego de dos  
 Un jeu de deux  
 Two units  
 6,54 Kg  
 Ref. **170 BG 10**  
 Estantería  
 Étagère  
 Shelf  
 6,54 Kg  
**F 1000mm**



Ref. **170 ACC 08**  
 Juego de accesorios  
 Jeu d'accessoires  
 Accessory set  
 8,5 Kg  
**F 800mm**

Ref. **170 ACC 10**  
 Juego de accesorios  
 Jeu d'accessoires  
 Accessory set  
 10 Kg  
**F 1000mm**

INCLUYE  
 Rostros galvanizados:  
 (P800-P1000)  
 Separadores y tornillería.  
 COMPREND  
 Supports galvanisés:  
 (P800-P1000)  
 Séparateurs et vis.  
 INCLUDES  
 Galvanized supports:  
 (P800-P1000)  
 Dividers and screws.  
**SERIE TAP**  
 Protección inferior  
 Protection inférieure  
 Bottom protection

TAP-10930      TAP-35017  
 TAP-10931      TAP-10000  
 TAP-10933      TAP-35050  
 TAP-35019      TAP-10936

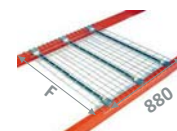

Ref. **TAP-09012**  
 Plataforma  
 Plateformes  
 Platforms  
 8,5 Kg  
**F 800mm**  
 Ref. **TAP-09001**  
 Plataforma  
 Plateformes  
 Platforms  
 10 Kg  
**F 1000mm**

SERIE **171**

Estanterías metálicas ligeras con tornillos.  
Étagères légères métalliques avec vis.  
Lightweight metal shelves with screws.

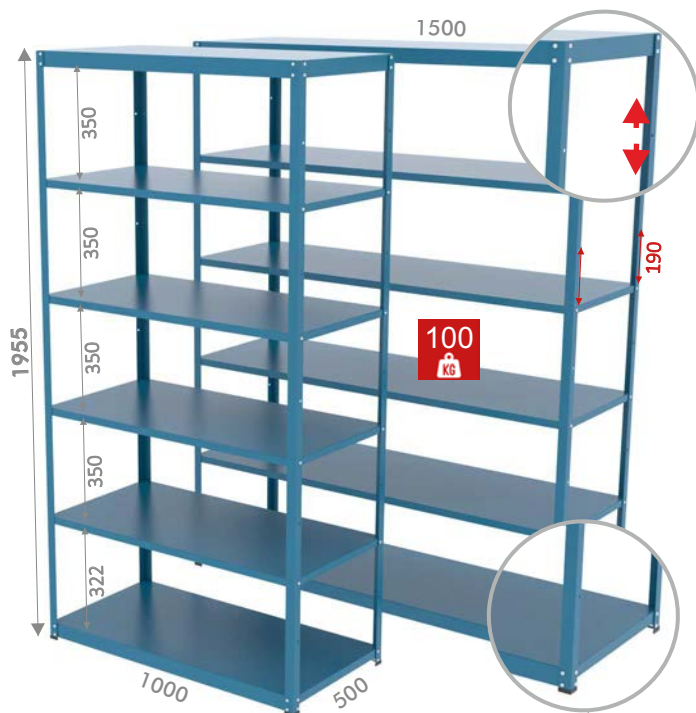
Ref. **171 10**Ref. **171 15**

Bandejas graduables cada 190mm.  
Plateaux réglables chaque de 190 mm.  
Adjustable trays every 190mm.

**4** Bandejas incluidas.  
Plateaux réglables compris.  
Adjustable trays including.

500 1000

Ref. **171 10 G**

1500

Ref. **171 15 G**

Recubrimiento plástico en los extremos de las patas.  
Les extrémités des pieds ont un revêtement plastique.  
The foot ends included a plastic coating.

Apoyo al suelo.  
Soutien au sol.  
Floor support.



Gama de producto  
Gamme de produits  
Product range

 PINTADO: Azul martelé.  
PEINTURE : Bleu martelé.  
PAINTING: Blue hammered.

Ref. **171 10**  
 42,13 Kg  
4u. 171 10 BG

Ref. **171 15**  
 58,65 Kg  
4u. 171 15 BG

 Acero galvanizado.  
Acier galvanisé.  
Galvanized steel.

Ref. **171 10 G**  
 42,13 Kg  
4u. 171 10 BG G

Ref. **171 15 G**  
 58,65 Kg  
4u. 171 15 BG G

Accesorios opcionales  
Accessoires optionnels  
Optional accessories

Ref. **171 R**

Ø 50 mm  
H 65 mm



OPCIÓN: Ruedas.  
OPTION: Roues.  
OPTION: Wheels.  40

Ht 1995mm

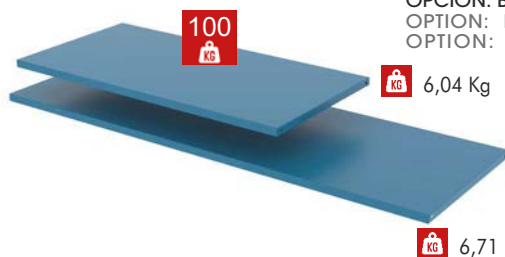

 6,04 Kg

 6,71 Kg

OPCIÓN: Bandejas graduables.  
OPTION: Plateaux réglables.  
OPTION: Adjustable trays.

Ref. **171 10 BG**  
Ref. **171 15 BG**

Ref. **171 10 BG G**  
Ref. **171 15 BG G**



SE SIRVE DESMONTADO. Montaje con tornillos, incluidos.  
SERVI DÉMONTÉ. Assemblage avec vis, inclus.  
SERVED DISASSEMBLED. Assembly with screws, included.

## SERIE 222-223

Armario para mostradores (ejemplo de composición).  
Armoire de comptoir (exemple de composition).  
Counter cabinet (example of composition).

Accesorios opcionales  
Accessoires optionnels  
Optional accessories



## SERIE 223



## Ref. 222 2

30,26 Kg

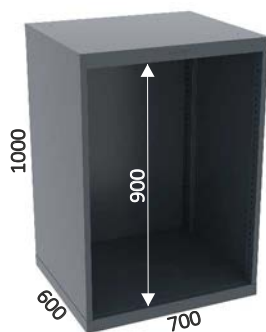

## Ref. 223 2

37,57 Kg

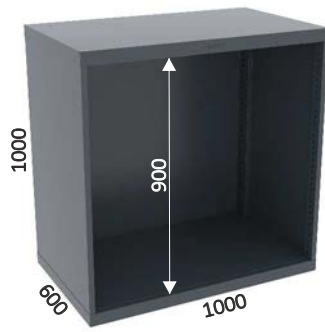

Consultar plazo de entrega.  
Consulter le délai de livraison.  
Check delivery time.



No incluye sistema antivuelco.  
Ne comprend pas le système anti-renversement.  
Does not include anti-roll system.

RAL 3020 /  
RAL 7016



## SERIE 222

## Ref. 222 BG

3,63 Kg

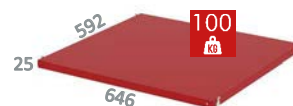

## Ref. 222 BE T50

6,07 Kg

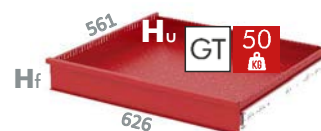
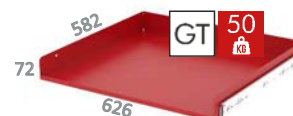

## Ref. 222 T50 C75

7,12 Kg

Hf 75mm Hu 40mm

## Ref. 222 T50 C100

7,87 Kg

Hf 100mm Hu 65mm

## Ref. 222 T50 C125

8,62 Kg

Hf 125mm Hu 90mm

## Ref. 222 T50 C200

9,00 Kg

Hf 200mm Hu 165mm

## SERIE 223

## Ref. 223 BG

5,22 Kg



## Ref. 223 BE T50

7,67 Kg

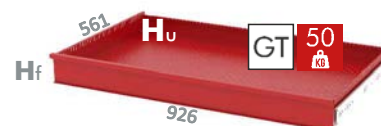
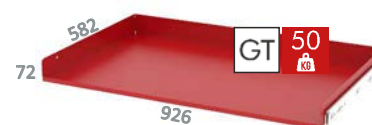

## Ref. 223 T50 C75

8,02 Kg

Hf 75mm Hu 40mm

## Ref. 223 T50 C100

8,77 Kg

Hf 100mm Hu 65mm

## Ref. 223 T50 C125

9,52 Kg

Hf 125mm Hu 90mm

## Ref. 223 T50 C200

9,90 Kg

Hf 200mm Hu 165mm



OPCIÓN: Divisiones en acero galvanizado.  
OPTION: Separations en acier galvanisé.  
OPTION: Galvanized steel divisions.

**SERIE 161**

Armario 2 puertas con bandejas.  
Armoire 2 portes et plateaux.  
2 door cabinet with trays.



Según normativa STAWA-R.  
Selon normative STAWA-R.  
As per STAWA-R regulations.



**Ref. 161 1**

**KG** 105,5 Kg  
**e** 1 mm

**3u. 161 BG 1**

Bandeja regulable.  
Plateau réglable.  
Adjustable tray.  
**e** 2 mm

**1u. 161 BC 1**

Bandeja colector de líquidos.  
Plateau collecteur de liquides.  
Tray for liquid collection.  
**e** 3 mm

**Ref. 161 BG 1**

**KG** 10 Kg

Orificio para la extracción Ø75 mm.  
Orifice d'extraction Ø75 mm.  
Extraction hole Ø75 mm.

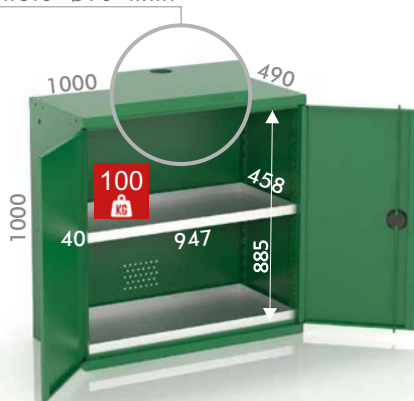

**Ref. 161 2**

**KG** 59 Kg  
**e** 1 mm

**1u. 161 BG 1**

Bandeja regulable.  
Plateau réglable.  
Adjustable tray.  
**e** 2 mm

**1u. 161 BC 1**

Bandeja colector de líquidos.  
Plateau collecteur de liquides.  
Tray for liquid collection.  
**e** 3 mm

**Ref. 161 BG 1**

**KG** 10 Kg

Bandeja zincada, orificio de ventilación.  
Bac zingué, orifice d'aération.  
Zinc-coated, holes of ventilation.

ADHESIVO FITOSANITARIO.  
ADHÉSIF PHYTOSANITAIRE.  
PHYTOSANITAIRE ADHESIVE.



Ref. 161 ES

Ref. 161 FR

UNIDAD DE EXTRACCIÓN DE AIRE.  
UNITÉ D'EXTRACTION D'AIR.  
AIR EXTRACTION UNIT.



SIN ventilador.  
SANS ventilateur.  
WITHOUT fan.

**Ref. D-2.00.360**

**KG** 2 Kg



**Ref. 161 3**

**KG** 82 Kg  
**e** 1 mm

**3u. 161 BG 3**

Bandeja regulable.  
Plateau réglable.  
Adjustable tray.  
**e** 2 mm

**1u. 161 BC 3**

Bandeja colector de líquidos.  
Plateau collecteur de liquides.  
Tray for liquid collection.  
**e** 3 mm

**Ref. 161 BG 3**

**KG** 8 Kg



**Ref. 161 4**

**KG** 61 Kg  
**e** 1 mm

**3u. 161 BG 4**

Bandeja regulable.  
Plateau réglable.  
Adjustable tray.  
**e** 2 mm

**1u. 161 BC 4**

Bandeja colector de líquidos.  
Plateau collecteur de liquides.  
Tray for liquid collection.  
**e** 3 mm

**Ref. 161 BG 4**

**KG** 6 Kg

**RAL 6029**

NO APTOS PARA PRODUCTOS INFLAMABLES Y EXPLOSIVOS.  
NE CONVIENT PAS AUX PRODUITS INFLAMMABLES ET EXPLOSIFS.  
NOT SUITABLE FOR FLAMMABLE AND EXPLOSIVE PRODUCTS.



CON ventilador.  
AVEC ventilateur.  
WITH fan.

**Ref. D-2.00.340**

**KG** 10 Kg



**SERIE 130**

Armarios para productos de primeros auxilios y/o de farmacia.  
Armoires pour produits de premier secours et/ou de pharmacie.  
Cabinets for first-aid or pharmaceutical products.

ARMARIOS - BOTIQUÍN  
ARMOIRES DE PREMIER SECOURS  
FIRST-AID CABINETS



**Ref. 130 1**

**KG** 5,5 Kg  
**1** Estante  
Étagère  
Shelf



**Ref. 130 2**

**KG** 8 Kg  
**2** Estantes  
Étagères  
Shelves

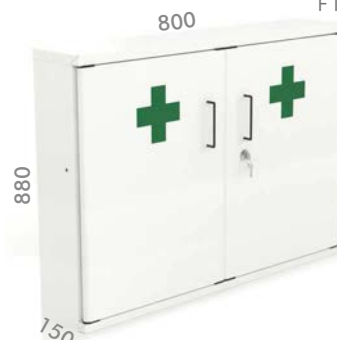

**Ref. 130 3**

**KG** 22 Kg  
**2** Estantes  
Étagères  
Shelves

**e** 0,6 mm

**RAL 9010**



Bandejas interiores fijas / Asa para fácil abertura.  
Plateaux intérieurs fixes / Poignée pour faciliter l'ouverture.  
Fixed inner trays / Easy opening handle.

SERIE **304**

Bancos en acero inoxidable  
Bancs de vestiaire en acier inoxydable  
Stainless-steel benches

**e** 1,5 mm



Ref. **304 BV 20**

**KG** 11 Kg

Ref. **304 BV 15**

**KG** 14,75 Kg

Ref. **304 BV 10**

**KG** 18,5 Kg

□ 40x40x1,5 mm

AISI 304 L

**e** 1,5-2 mm



Consultar plazo de entrega.  
Consulter le delai de livraison.  
Check delivery time.



Refuerzo bajo encimera.  
Renfort sous le plan de travail.  
Under-worktop support.

□ 40x60x2 mm



Ref. **304 BT 15**

**KG** 46 Kg

Ref. **304 BT 20**

**KG** 60 Kg

Ref. **304 BT 30**

**KG** 100 Kg



Encimera.  
Plan de travail.  
Worktop.

**e** 2 mm

**H** 44 mm

Armario vestuario en acero inoxidable  
Armoire vestiaire en acier inoxydable  
Stainless-steel lockers

**e** 1 mm

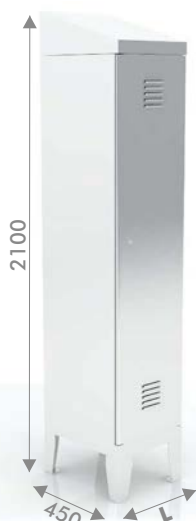
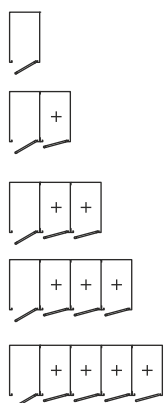

Ref. **304 1**

**KG** 30,3 Kg **L** 310mm

Ref. **304 1 2**

**KG** 60,6 Kg **L** 620mm

Ref. **304 1 3**

**KG** 90,9 Kg **L** 930mm

Ref. **304 1 4**

**KG** 121,2 Kg **L** 1240mm

Ref. **304 1 5**

**KG** 151,5 Kg **L** 1550mm

**i** 1u. Bandeja perchero  
1u. Plateau porte-manteau  
1u. Clothes rack tray



Ref. **304 2**

**KG** 30,6 Kg **L** 310mm

Ref. **304 2 2**

**KG** 61,2 Kg **L** 620mm

Ref. **304 2 3**

**KG** 91,8 Kg **L** 930mm

Ref. **304 2 4**

**KG** 122,4 Kg **L** 1240mm

Ref. **304 2 5**

**KG** 153 Kg **L** 1550mm

**i** 2u. Bandeja perchero  
2u. Plateau porte-manteau  
2u. Clothes rack tray

SERIE **304**

Armarios en acero inoxidable  
Armoires en acier inoxydable  
Stainless-steel cabinets



Ref. **304 3**

85 Kg



Ref. **304 3 TI**

85 Kg



Ref. **304 4**

74 Kg

SERIE **115 C - 122 C**

Armario esquinero con y sin puertas (H:1000mm).  
Armoire d'angle avec ou sans portes (H:1000 mm).  
Corner cabinet with or without doors (H:1000 mm).

Ref. **115 C**

- 47 Kg
- 1 m<sup>3</sup>
- sin puertas  
sans portes  
without doors

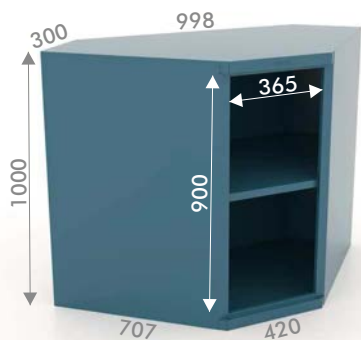

OPCIÓN: Puerta.  
OPTION: Porte.  
OPTION: Door.

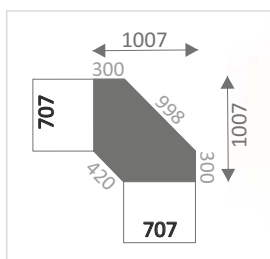

Ref. **115 CP**

- 44 Kg
- 0,651 m<sup>3</sup>
- con puertas  
avec portes  
with doors

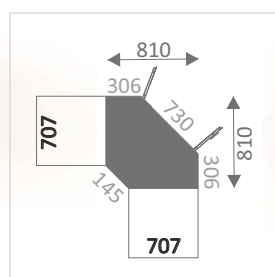
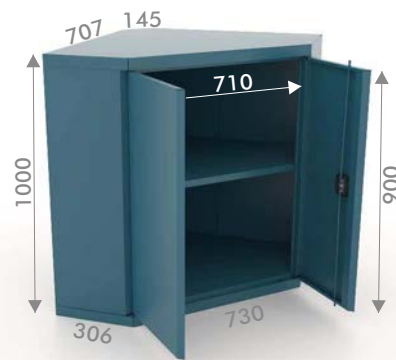

Ref. **122 C**

- 40 Kg
- 0,804 m<sup>3</sup>
- sin puertas  
sans portes  
without doors

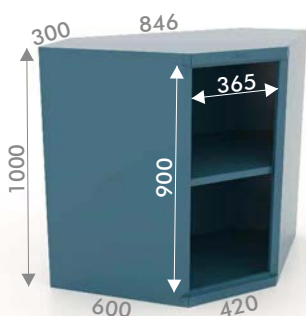

OPCIÓN: Puerta.  
OPTION: Porte.  
OPTION: Door.

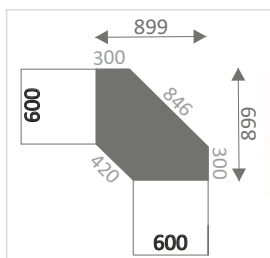

Ref. **122 CP**

- 38 Kg
- 0,651 m<sup>3</sup>
- con puertas  
avec portes  
with doors

