

SERIE 170

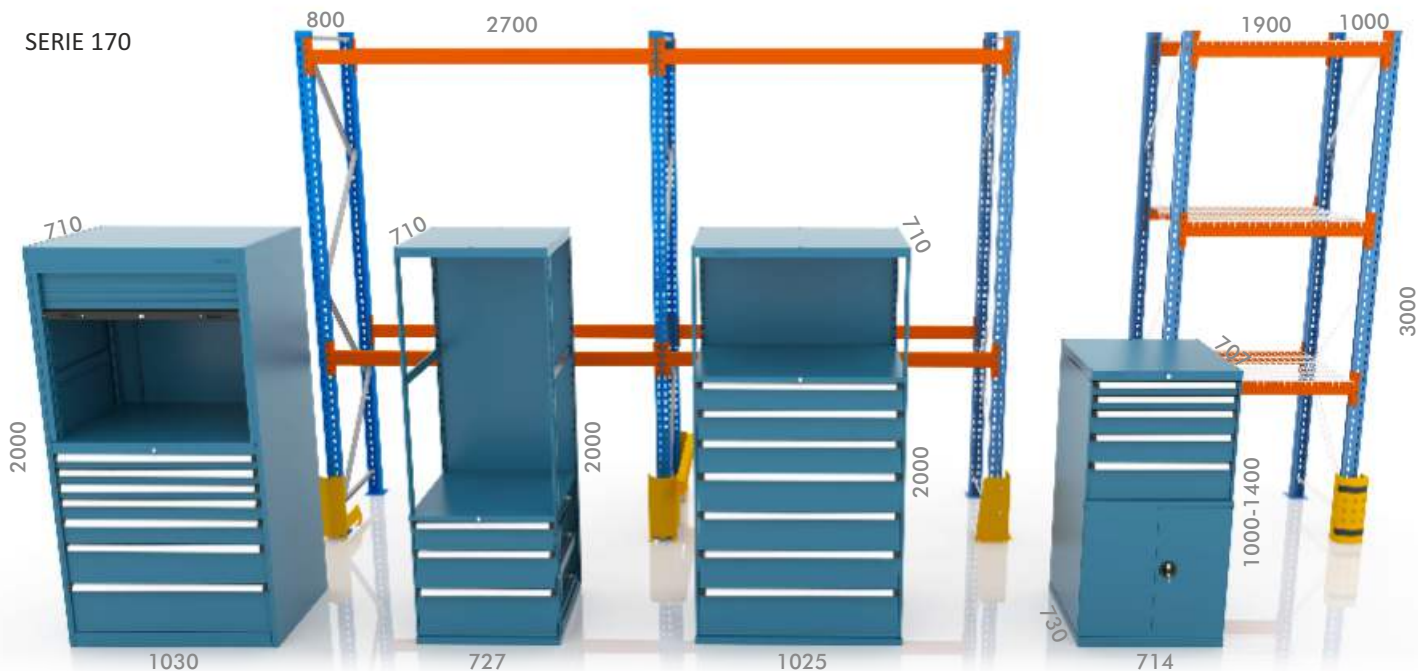

SERIE 119 E P C

SERIE 115 E

SERIE 119 E

SERIE 127



MOSTRADORES A MEDIDA    COMPTOIRS SUR MESURE    CUSTOM-MADE COUNTERS

accesorios  
accessoires  
accessories

115 EG

119 EG

SERIE 115 E  
SERIE 119 E  
SERIE 119 E P C

115 E 1 P  
119 E 1 P

SERIE tap



TAP-10936



TAP-10000  
TAP- 35050

TAP-35019



TAP-35017



TAP-10930

TAP-10931



TAP-10933

SERIE 127

127 BG

127 BE T100

127 BE T200



127 T200 40

127 T200 50

127 T100 300



información  
information  
information

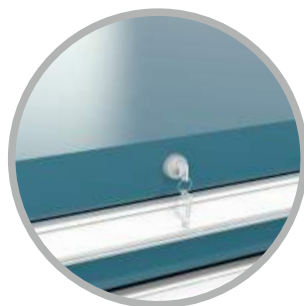

Cierre centralizado.  
Verrouillage centralisé.  
Central locking.



Sistema antivuelco.  
Système anti-renversement.  
Anti-roll system.



Orificio para la extracción Ø75 mm.  
Orifice d'extraction Ø75 mm.  
Extraction hole Ø75 mm.



Bandeja zincada, orificio de ventilación.  
Bac zingué, orifice d'aération.  
Zinc-coated, holes of ventilation.

- [ES]**
  - Gran variedad de medidas y configuraciones.
  - Diseño robusto y resistente.
  - Alta resistencia de carga.
  - Varias configuraciones.
  - Apertura de puertas de 180 °.
  - Color estándar azul martelé posibilidad colores en opción. SERIE 170 (RAL 5017 - RAL 2009).
  - Armarios para el almacenaje y uso específico:
    - Fitosanitarios (RAL 6029, bandejas según normativa STAWA-R).
    - Botiquines (RAL 9016, según normativa).
- [FR]**
  - Grande variété de tailles et configurations.
  - Conception robuste et résistante.
  - Forte résistance au chargement.
  - Plusieurs configurations.
  - Ouverture des portes à 180 °.
  - Couleur standard bleu martelé possibilité teintes en option. SÉRIE 170 (RAL 5017 - RAL 2009).
  - Armoires pour le stockage de produits spécifiques:
    - Phytosanitaire. (RAL 6029, plateaux selon normative STAWA-R).
    - Soins de premier secours (RAL 9016).
- [EN]**
  - Wide range of sizes and configurations.
  - Strong and resistant design.
  - High weight-bearing resistance.
  - Several configurations.
  - 180 ° opening doors.
  - Standard colour hammered blue possibility optional colours. SERIE 170 (RAL 5017 - RAL 2009).
  - Storage cabinets for specific use:
    - Phytosanitary (RAL 6029, trays according to STAWA-R regulations).
    - First-aid kit (RAL 9016).

**SERIE 115 E**

Cierre centralizado.  
Verrouillage centralisé.  
Central locking.

Sistema antivuelco.  
Système anti-renversement.  
Anti-roll system.

Armarios con cajones y estanterías.  
Armoires avec tiroirs et étagères.  
Cabinets with drawers and shelves.

WWW

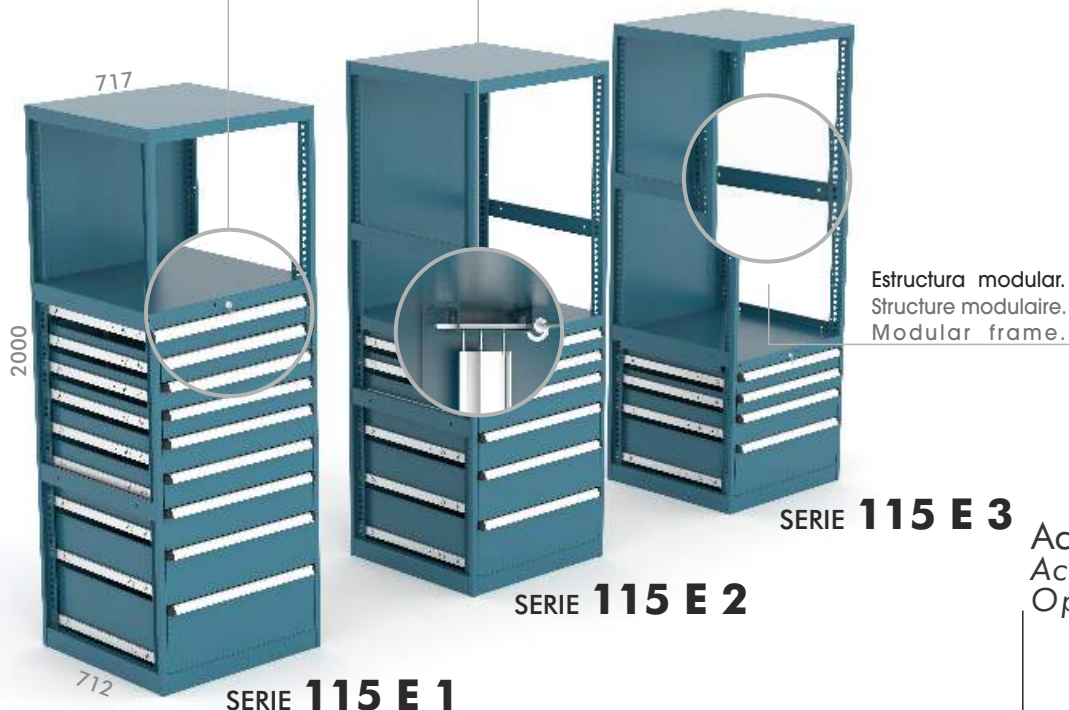

**SERIE 115 E 1 MC**

75 Kg

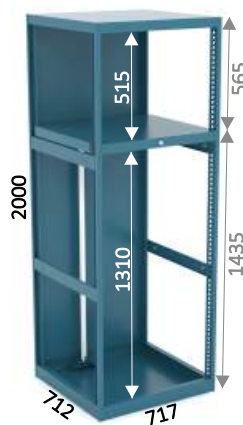

**SERIE 115 E 2 MC**

75 Kg

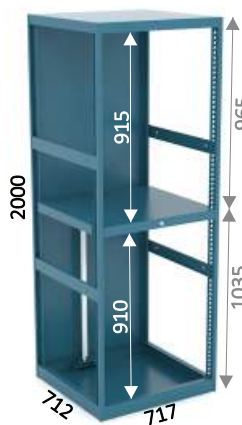

**SERIE 115 E 3 MC**

75 Kg

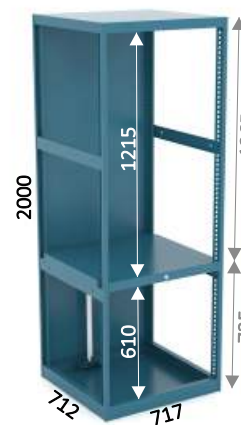

1 mm

Plazo de entrega 10 días laborables.  
Délai de livraison 10 jours ouvrables.  
Delivery time 10 working days.

**Cajones / Tiroirs / Drawers**

Guías telescópicas.  
Glissières télescopiques.  
Telescopic slides.

SERIE 115	C=50	●	115 T100 C50	10,5Kg
	C=75	●	115 T100 C75	11Kg
	C=100	●	115 T100 C100	12,5Kg
	C=125	●	115 T100 C125	13Kg
	C=150	●	115 T100 C150	13,5Kg
	C=200	●	115 T100 C200	14,5Kg
	C=250	●	115 T100 C250	15,5Kg
	C=300	●		
				1.5 mm

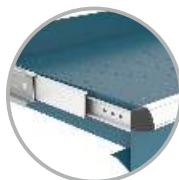

GT Apertura 100%.  
Ouverture 100%.  
100% opening.

Los cajones no incluyen divisiones.  
Le tiroirs non inclus les séparations.  
Divisions non included at drawers.

**SERIE 115 E 3**

Accesorios opcionales  
Accessoires optionnels  
Optional accessories



SERIE **115 E**

Gama de producto  
 Gamme de produits  
 Product range

SERIE **115 E 1**



SERIE **115 E 1 4 11**

174,5 Kg  
 1u. 115 T100 C100  
 6u. 115 T100 C200

SERIE **115 E 1 4 12**

172,5 Kg  
 2u. 115 T100 C150  
 5u. 115 T100 C200

SERIE **115 E 1 4 13**

185 Kg  
 4u. 115 T100 C100  
 2u. 115 T100 C200  
 2u. 115 T100 C250

SERIE **115 E 1 4 14**

185 Kg  
 1u. 115 T100 C75  
 2u. 115 T100 C200  
 1u. 115 T100 C125  
 2u. 115 T100 C200  
 2u. 115 T100 C250

SERIE **115 E 1 4 15**

202 Kg  
 4u. 115 T100 C75  
 1u. 115 T100 C100  
 2u. 115 T100 C125  
 2u. 115 T100 C200  
 1u. 115 T100 C250

SERIE **115 E 1 4 16**

191 Kg  
 2u. 115 T100 C75  
 3u. 115 T100 C100  
 2u. 115 T100 C125  
 1u. 115 T100 C150  
 1u. 115 T100 C200  
 1u. 115 T100 C250

SERIE **115 E 1 4 17**

208,5 Kg  
 8u. 115 T100 C75  
 1u. 115 T100 C200  
 2u. 115 T100 C250

SERIE **115 E 1 4 18**

220 Kg  
 7u. 115 T100 C75  
 3u. 115 T100 C125  
 1u. 115 T100 C150  
 1u. 115 T100 C250

SERIE **115 E 1 4 19**

237 Kg  
 13u. 115 T100 C100

SERIE **115 E 2**



SERIE **115 E 2 2 11**

134 Kg  
 1u. 115 T100 C100  
 4u. 115 T100 C200

SERIE **115 E 2 2 12**

155 Kg  
 1u. 115 T100 C75  
 1u. 115 T100 C100  
 1u. 115 T100 C125  
 1u. 115 T100 C150  
 1u. 115 T100 C200  
 1u. 115 T100 C250

SERIE **115 E 2 2 13**

156 Kg  
 6u. 115 T100 C150

SERIE **115 E 2 2 14**

163,5 Kg  
 3u. 115 T100 C75  
 1u. 115 T100 C100  
 1u. 115 T100 C125  
 1u. 115 T100 C200  
 1u. 115 T100 C250

SERIE **115 E 2 2 15**

175 Kg  
 2u. 115 T100 C75  
 2u. 115 T100 C100  
 2u. 115 T100 C125  
 2u. 115 T100 C150

SERIE **115 E 2 2 16**

184,5 Kg  
 3u. 115 T100 C75  
 4u. 115 T100 C100  
 1u. 115 T100 C125  
 1u. 115 T100 C150

SERIE **115 E 2 2 17**

187,5 Kg  
 9u. 115 T100 C100

SERIE **115 E 2 2 18**

200,5 Kg  
 8u. 115 T100 C75  
 3u. 115 T100 C100

SERIE **115 E 2 2 19**

207 Kg  
 12u. 115 T100 C75

SERIE **115 E 3**



SERIE **115 E 3 1 11**

118 Kg  
 1u. 115 T100 C150  
 1u. 115 T100 C200  
 1u. 115 T100 C250

SERIE **115 E 3 1 12**

129 Kg  
 2u. 115 T100 C100  
 2u. 115 T100 C200

SERIE **115 E 3 1 13**

129 Kg  
 4u. 115 T100 C150

SERIE **115 E 3 1 14**

127 Kg  
 2u. 115 T100 C75  
 1u. 115 T100 C200  
 1u. 115 T100 C250

SERIE **115 E 3 1 15**

128 Kg  
 2u. 115 T100 C100  
 1u. 115 T100 C150  
 1u. 115 T100 C250

SERIE **115 E 3 1 16**

137,5 Kg  
 2u. 115 T100 C75  
 1u. 115 T100 C100  
 1u. 115 T100 C150  
 1u. 115 T100 C200

SERIE **115 E 3 1 17**

138,5 Kg  
 1u. 115 T100 C75  
 2u. 115 T100 C100  
 1u. 115 T100 C125  
 1u. 115 T100 C200

SERIE **115 E 3 1 18**

150 Kg  
 6u. 115 T100 C100

SERIE **115 E 3 1 19**

141 Kg  
 8u. 115 T100 C75

**SERIE 119 E**

Cierre centralizado.  
Verrouillage centralisé.  
Central locking.

Sistema antivuelco.  
Système anti-renversement.  
Anti-roll system.

Armarios con cajones y estanterías.  
Armoires avec tiroirs et étagères.  
Cabinets with drawers and shelves.

WWW



Estructura modular.  
Structure modulaire.  
Modular frame.

**SERIE 119 E 3**

**SERIE 119 E 2**

**SERIE 119 E 1**

Accesorios opcionales  
Accessoires optionnels  
Optional accessories

**SERIE 119 E 1 MC**

112 Kg

**SERIE 119 E 2 MC**

112 Kg

**SERIE 119 E 3 MC**

112 Kg

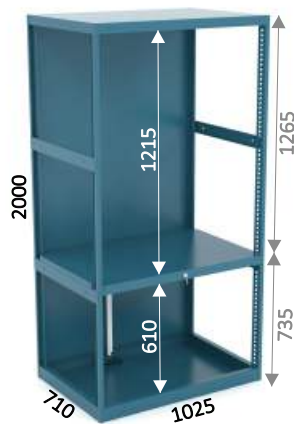
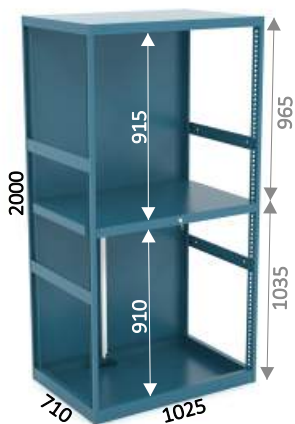
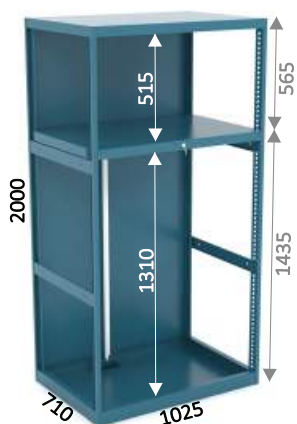

**SERIE 119 E 1 P 1**

8,4 Kg **H** 535

**SERIE 119 E 2 P 2**

10,7 Kg **H** 935

**SERIE 119 E 3 P 3**

12,5 Kg **H** 1235

**SERIE 119 E P**

14,3 Kg **H** 1915

**SERIE 115 E L**

13 Kg

Lateral  
Latéral  
Lateral



**SERIE 119 EG**

10 Kg

Estantería graduable  
Étagère réglable  
Adjustable shelf



**SERIE CE P 1**



Cierre electrónico  
Verrou électronique  
Electronic locking

SERIE CE P 1 - SERIE CE P 1 LL -  
SERIE CE P 1 TM - SERIE CE P 1 TU

1 mm

Plazo de entrega 10 días laborables.  
Délai de livraison 10 jours ouvrables.  
Delivery time 10 working days.

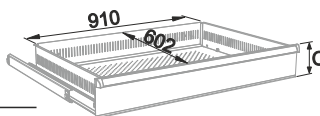

Cajones / Tiroirs / Drawers

Guías telescópicas.  
Glissières télescopiques.  
Telescopic slides.



GT Apertura 100%.  
Ouverture 100%.  
100% opening.

Los cajones no incluyen divisiones.  
Le tiroirs non inclus les séparations.  
Divisions non included at drawers.

		GT	100	
SERIE 119	C=50	●	119 T100 C75	15,5Kg
	C=75	●	119 T100 C100	16,5Kg
	C=100	●	119 T100 C125	17,5Kg
	C=125	●	119 T100 C150	18,5Kg
	C=150	●	119 T100 C200	19Kg
	C=200	●	119 T100 C250	20Kg
	C=250	●	119 T100 C250	22,5Kg
	C=300	●		
		e	1.5 mm	

SERIE **119 E**

Gama de producto  
 Gamme de produits  
 Product range

SERIE **119 E 1**



SERIE **119 E 1 4 11**

249,5 Kg  
 1u. 119 T100 C100  
 6u. 119 T100 C200

SERIE **119 E 1 4 12**

295 Kg  
 2u. 119 T100 C150  
 5u. 119 T100 C200

SERIE **119 E 1 4 13**

262 Kg  
 4u. 119 T100 C100  
 2u. 119 T100 C200  
 2u. 119 T100 C250

SERIE **119 E 1 4 14**

267 Kg  
 1u. 119 T100 C75  
 2u. 119 T100 C200  
 1u. 119 T100 C125  
 2u. 119 T100 C200  
 2u. 119 T100 C250

SERIE **119 E 1 4 15**

295 Kg  
 4u. 119 T100 C75  
 1u. 119 T100 C100  
 2u. 119 T100 C125  
 2u. 119 T100 C200  
 1u. 119 T100 C250

SERIE **119 E 1 4 16**

278,5 Kg  
 2u. 119 T100 C75  
 3u. 119 T100 C100  
 2u. 119 T100 C125  
 1u. 119 T100 C150  
 1u. 119 T100 C200  
 1u. 119 T100 C250

SERIE **119 E 1 4 17**

309 Kg  
 8u. 119 T100 C75  
 1u. 119 T100 C200  
 2u. 119 T100 C250

SERIE **119 E 1 4 18**

324,5 Kg  
 7u. 119 T100 C75  
 3u. 119 T100 C125  
 1u. 119 T100 C150  
 1u. 119 T100 C250

SERIE **119 E 1 4 19**

339,5 Kg  
 13u. 119 T100 C100

SERIE **119 E 2**



SERIE **119 E 2 2 11**

215 Kg  
 1u. 119 T100 C100  
 4u. 119 T100 C200

SERIE **119 E 2 2 12**

226 Kg  
 1u. 119 T100 C75  
 1u. 119 T100 C100  
 1u. 119 T100 C125  
 1u. 119 T100 C150  
 1u. 119 T100 C200  
 1u. 119 T100 C250

SERIE **119 E 2 2 13**

226 Kg  
 6u. 119 T100 C150

SERIE **119 E 2 2 14**

240 Kg  
 3u. 119 T100 C75  
 1u. 119 T100 C100  
 1u. 119 T100 C125  
 1u. 119 T100 C200  
 1u. 119 T100 C250

SERIE **119 E 2 2 15**

255 Kg  
 2u. 119 T100 C75  
 2u. 119 T100 C100  
 2u. 119 T100 C125  
 2u. 119 T100 C150

SERIE **119 E 2 2 16**

269 Kg  
 3u. 119 T100 C75  
 4u. 119 T100 C100  
 1u. 119 T100 C125  
 1u. 119 T100 C150

SERIE **119 E 2 2 17**

269,5 Kg  
 9u. 119 T100 C100

SERIE **119 E 2 2 18**

296,5 Kg  
 8u. 119 T100 C75  
 3u. 119 T100 C100

SERIE **119 E 2 2 19**

310 Kg  
 12u. 119 T100 C75

SERIE **119 E 3**



SERIE **119 E 3 1 11**

173,5 Kg  
 1u. 119 T100 C150  
 1u. 119 T100 C200  
 1u. 119 T100 C250

SERIE **119 E 3 1 12**

187 Kg  
 2u. 119 T100 C100  
 2u. 119 T100 C200

SERIE **119 E 3 1 13**

188 Kg  
 4u. 119 T100 C150

SERIE **119 E 3 1 14**

187,5 Kg  
 2u. 119 T100 C75  
 1u. 119 T100 C200  
 1u. 119 T100 C250

SERIE **119 E 3 1 15**

188,5 Kg  
 2u. 119 T100 C100  
 1u. 119 T100 C150  
 1u. 119 T100 C250

SERIE **119 E 3 1 16**

201 Kg  
 2u. 119 T100 C75  
 1u. 119 T100 C100  
 1u. 119 T100 C150  
 1u. 119 T100 C200

SERIE **119 E 3 1 17**

202 Kg  
 1u. 119 T100 C75  
 2u. 119 T100 C100  
 1u. 119 T100 C125  
 1u. 119 T100 C200

SERIE **119 E 3 1 18**

217 Kg  
 6u. 119 T100 C100

SERIE **119 E 3 1 19**

244 Kg  
 8u. 119 T100 C75

**SERIE 119 E P C**

Cierre centralizado.  
Verrouillage centralisé.  
Central locking.

Armarios con cajones y estanterías (cierre con persiana).  
Armoires avec tiroirs et étagères (fermeture avec rideau).  
Cabinets with drawers and shelves (shutter closing).

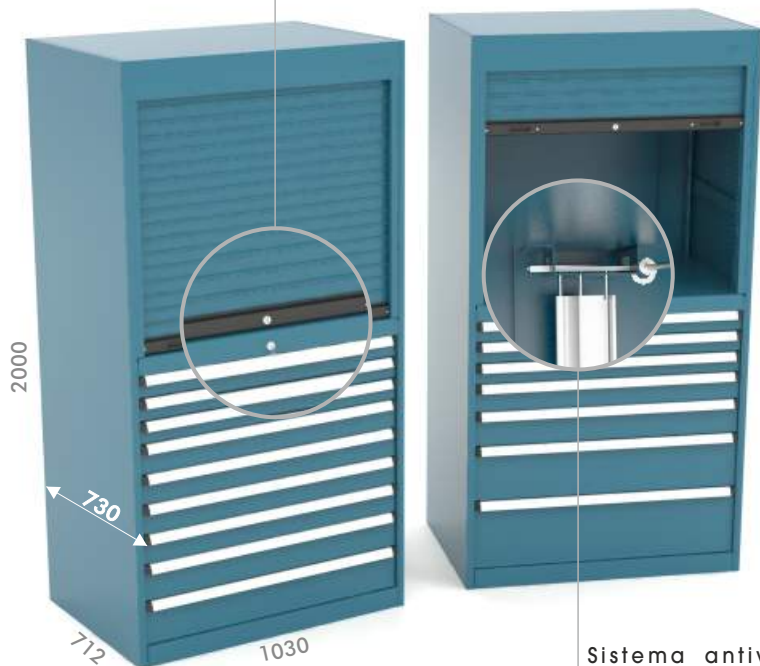

Sistema antivuelco.  
Système anti-renversement.  
Roll-over protection system.

**SERIE 119 E P C**

160 Kg

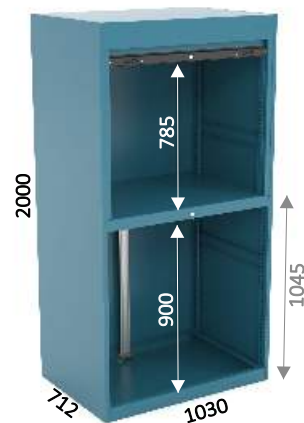

Accesorios opcionales  
Accessoires optionnels  
Optional accessories

**SERIE 119 EGP**

10 Kg

Estantería graduable  
Étagère réglable  
Adjustable shelf

**SERIE CE P 1**



Cierre electrónico  
Verrou électronique  
Electronic locking

SERIE CE P 1 - SERIE CE P 1 LL -  
SERIE CE P 1 TM - SERIE CE P 1 TU

1 mm

Plazo de entrega 10 días laborables.  
Délai de livraison 10 jours ouvrables.  
Delivery time 10 working days.

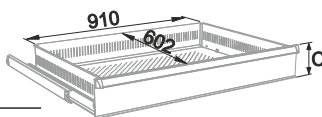
Cajones / Tiroirs / Drawers



Guías telescópicas.  
Glissières télescopiques.  
Telescopic slides.

Apertura 100%.  
Ouverture 100%.  
100% opening.



Los cajones no incluyen divisiones.  
Les tiroirs non incluent les séparations.  
Divisions non included at drawers.

		GT	100	
SERIE 119	C=50	●	119 T100 C75	15,5Kg
	C=75	●	119 T100 C100	16,5Kg
	C=100	●	119 T100 C125	17,5Kg
	C=125	●	119 T100 C150	18,5Kg
	C=150	●	119 T100 C200	19Kg
	C=200	●	119 T100 C250	20Kg
	C=250	●	119 T100 C250	22,5Kg
C=300				
				1.5 mm

Gama de producto  
Gamme de produits  
Product range

**SERIE 119 E P C 2 11**

251 Kg

1u. 119 T100 C100  
4u. 119 T100 C200

**SERIE 119 E P C 2 12**

262 Kg

1u. 119 T100 C75  
1u. 119 T100 C100  
1u. 119 T100 C125  
1u. 119 T100 C150  
1u. 119 T100 C200  
1u. 119 T100 C250

**SERIE 119 E P C 2 13**

262 Kg

6u. 119 T100 C150

**SERIE 119 E P C 2 14**

276 Kg

3u. 119 T100 C75  
1u. 119 T100 C100  
1u. 119 T100 C125  
1u. 119 T100 C200  
1u. 119 T100 C250

**SERIE 119 E P C 2 15**

291 Kg

2u. 119 T100 C75  
2u. 119 T100 C100  
2u. 119 T100 C125  
2u. 119 T100 C150

**SERIE 119 E P C 2 16**

305 Kg

3u. 119 T100 C75  
4u. 119 T100 C100  
1u. 119 T100 C125  
1u. 119 T100 C150

**SERIE 119 E P C 2 17**

305,5 Kg

9u. 119 T100 C100

**SERIE 119 E P C 2 18**

305,5 Kg

8u. 119 T100 C75  
3u. 119 T100 C100

**SERIE 119 E P C 2 19**

346 Kg

12u. 119 T100 C75

SERIE 127

WWW

Armario con puertas y cajones.  
 Armoire avec portes et tiroirs.  
 Cabinets with doors and drawers.

Sistema antivuelco.  
 Système anti-renversement.  
 Roll-over protection system.

Cierre centralizado.  
 Verrouillage centralisé.  
 Central locking.



Cajones  
 Tiroirs  
 Drawers

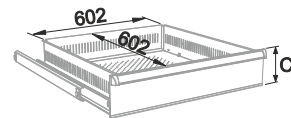

SERIE 115



C=50	●	115 T100 C50	10,5Kg
C=75	●	115 T100 C75	11Kg
C=100	●	115 T100 C100	12,5Kg
C=125	●	115 T100 C125	13Kg
C=150	●	115 T100 C150	13,5Kg
C=200	●	115 T100 C200	14,5Kg
C=250	●	115 T100 C250	15,5Kg
C=300	●		

1.5 mm

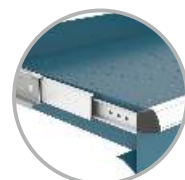

Guías telescópicas.  
 Glissières télescopiques.  
 Telescopic slides.



Apertura 100%.  
 Ouverture 100%.  
 100% opening.



No incluyen divisiones.  
 Non inclus les séparations.  
 Divisions not included.

1 mm



Plazo de entrega 10 días laborables.  
 Délai de livraison 10 jours ouvrables.  
 Delivery time 10 working days.

SERIE 127 3

77,5 Kg

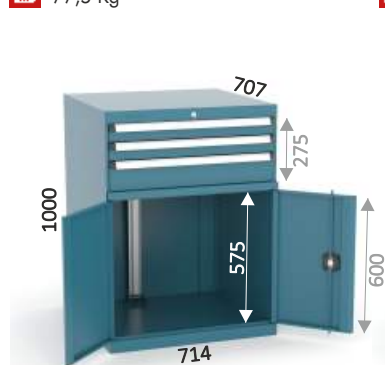

SERIE 127 4

109 Kg

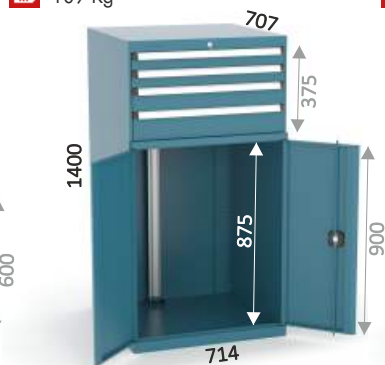

SERIE 127 5

96,5 Kg



SERIE 127 6

112 Kg



Accesorios opcionales  
 Accessoires optionnels  
 Optional accessories

SERIE 127 BG

4 Kg

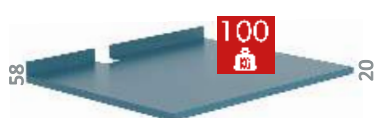

SERIE 127 BE T100

5 Kg



SERIE 127 BE T200

5,25 Kg



SERIE T200 50

25 Porta Conos ISO 50  
 25 Porte-Cônes ISO 50  
 25 Tool-Holder ISO 50

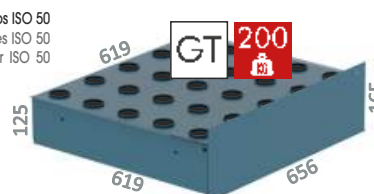

SERIE 127 T200 40

25 Porta Conos ISO 40  
 25 Porte-Cônes ISO 40  
 25 Tool-Holder ISO 40

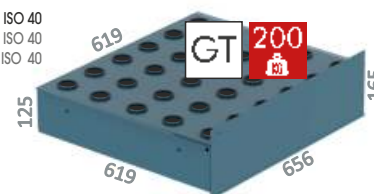

SERIE 127 T100 300

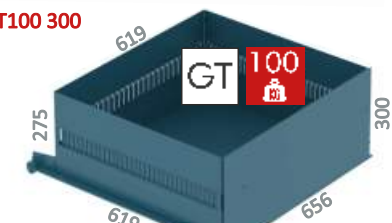



**SERIE 127**

 Gama de producto  
 Gamme de produits  
 Product range

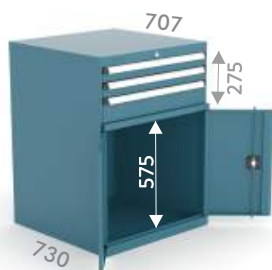
**SERIE 127 3**

**SERIE 127 3 1**

 77,5 Kg  
 2u. 115 T100 C75  
 1u. 115 T100 C125  
 2u. 127 BG

**SERIE 127 3 2**

 87,5 Kg  
 2u. 115 T100 C75  
 1u. 115 T100 C125  
 2u. 127 BE T100

**SERIE 127 3 3**

 104 Kg  
 2u. 115 T100 C75  
 1u. 115 T100 C125  
 1u. 127 BG  
 1u. 127 T100 300

**SERIE 127 3 4**

 112,5 Kg  
 2u. 115 T100 C75  
 1u. 115 T100 C125  
 1u. 127 BE T100  
 1u. 127 T100 300

**SERIE 127 3 5**

 140,5 Kg  
 2u. 115 T100 C75  
 1u. 115 T100 C125  
 1u. 127 BE T100  
 1u. 127 T200 40

**SERIE 127 3 6**

 123,5 Kg  
 2u. 115 T100 C75  
 1u. 115 T100 C125  
 1u. 127 T200 40  
 1u. 127 T200 50

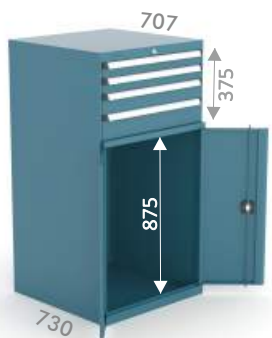
**SERIE 127 4**

**SERIE 127 4 1**

 97,5 Kg  
 2u. 115 T100 C75  
 1u. 115 T100 C100  
 1u. 115 T100 C125  
 2u. 127 BG

**SERIE 127 4 2**

 114,5 Kg  
 2u. 115 T100 C75  
 1u. 115 T100 C100  
 1u. 115 T100 C125  
 2u. 127 BE T100

**SERIE 127 4 3**

 146 Kg  
 2u. 115 T100 C75  
 1u. 115 T100 C100  
 1u. 115 T100 C125  
 1u. 127 BG  
 2u. 127 T100 300

**SERIE 127 4 4**

 129,5 Kg  
 2u. 115 T100 C75  
 1u. 115 T100 C100  
 1u. 115 T100 C125  
 1u. 127 BE T100  
 1u. 127 T100 300

**SERIE 127 4 5**

 127,5 Kg  
 2u. 115 T100 C75  
 1u. 115 T100 C100  
 1u. 115 T100 C125  
 1u. 127 BE T100  
 1u. 127 T200 50

**SERIE 127 4 6**

 147,5 Kg  
 2u. 115 T100 C75  
 1u. 115 T100 C100  
 1u. 115 T100 C125  
 1u. 127 T200 40  
 1u. 127 T200 50

**SERIE 127 5**

**SERIE 127 5 1**

 112 Kg  
 1u. 115 T100 C75  
 2u. 115 T100 C100  
 1u. 115 T100 C125  
 1u. 115 T100 C200  
 2u. 127 BG

**SERIE 127 5 2**

 129 Kg  
 1u. 115 T100 C75  
 2u. 115 T100 C100  
 1u. 115 T100 C125  
 1u. 115 T100 C200  
 2u. 127 BE T100

**SERIE 127 5 3**

 135,5 Kg  
 1u. 115 T100 C75  
 2u. 115 T100 C100  
 1u. 115 T100 C125  
 1u. 115 T100 C200  
 1u. 127 BG  
 1u. 115 T100 300

**SERIE 127 5 4**

 144 Kg  
 1u. 115 T100 C75  
 2u. 115 T100 C100  
 1u. 115 T100 C125  
 1u. 115 T100 C200  
 1u. 127 BE T100  
 1u. 127 T100 300

**SERIE 127 5 5**

 145,5 Kg  
 1u. 115 T100 C75  
 2u. 115 T100 C100  
 1u. 115 T100 C125  
 1u. 115 T100 C200  
 1u. 127 BE T100  
 1u. 127 T200 50

**SERIE 127 5 6**

 162 Kg  
 1u. 115 T100 C75  
 2u. 115 T100 C100  
 1u. 115 T100 C150  
 1u. 115 T100 C200  
 1u. 127 T200 40  
 1u. 127 T200 50

**SERIE 127 6**

**SERIE 127 6 1**

 121 Kg  
 2u. 115 T100 C75  
 2u. 115 T100 C100  
 1u. 115 T100 C125  
 1u. 115 T100 C200  
 2u. 127 BG

**SERIE 127 6 2**

 138 Kg  
 2u. 115 T100 C75  
 2u. 115 T100 C100  
 1u. 115 T100 C125  
 1u. 115 T100 C200  
 2u. 127 BE T100

**SERIE 127 6 3**

 144,5 Kg  
 2u. 115 T100 C75  
 2u. 115 T100 C100  
 1u. 115 T100 C125  
 1u. 115 T100 C200  
 1u. 127 BG  
 1u. 127 T100 300

**SERIE 127 6 4**

 153 Kg  
 2u. 115 T100 C75  
 2u. 115 T100 C100  
 1u. 115 T100 C125  
 1u. 115 T100 C200  
 1u. 127 BE T100  
 1u. 127 T200 300

**SERIE 127 6 5**

 154,5 Kg  
 2u. 115 T100 C75  
 2u. 115 T100 C100  
 1u. 115 T100 C125  
 1u. 115 T100 C200  
 1u. 127 BE T100  
 1u. 127 T200 50

**SERIE 127 6 6**

 171 Kg  
 2u. 115 T100 C75  
 2u. 115 T100 C100  
 1u. 115 T100 C125  
 1u. 115 T100 C200  
 1u. 127 T200 40  
 1u. 127 T200 50

SERIE **170**

WWW

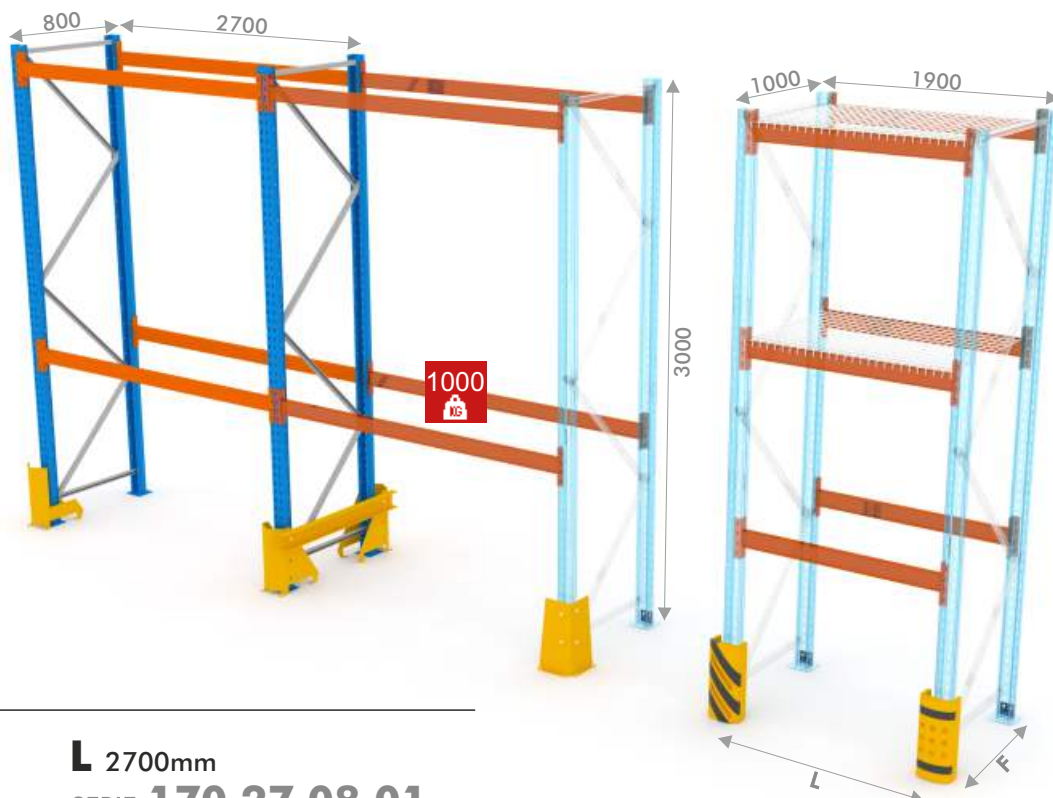

Gama de producto  
 Gamme de produits  
 Product range

**L** 1900mm

SERIE **170 19 08 01**

105 Kg **F** 800mm

SERIE **170 19 08 02**

75 Kg Módulos adicionales.  
 Modules additionnels./Additional modules.

SERIE **170 19 10 01**

106 Kg **F** 1000mm

SERIE **170 19 10 02**

77 Kg Módulos adicionales.  
 Modules additionnels./Additional modules.

**L** 2700mm

SERIE **170 27 08 01**

117 Kg **F** 800mm

SERIE **170 27 08 02**

87 Kg Módulos adicionales.  
 Modules additionnels./Additional modules.

SERIE **170 27 10 01**

121 Kg **F** 1000mm

SERIE **170 27 10 02**

89 Kg Módulos adicionales.  
 Modules additionnels./Additional modules.

HOMOLOGACIÓN HOMOLOGATION

EQUIPOS DE ALMACENAJE - UNE 58014.  
 ÉQUIPEMENTS DE STOCKAGE - UNE 58014.  
 STORAGE EQUIPMENT - UNE 58014.

Anclaje al suelo M12 (no incluido).  
 Fixation au sol M12 (non inclus).  
 Floor fixing M12 (not included).

Colores estándar. RAL 5017 /  
 Couleurs Standard. RAL 2009

Las patas laterales se sirven montadas.  
 Les pattes latérales sont servis montés.  
 Side covers are delivered assembled.

Accesorios  
 Accessoires  
 Accessories

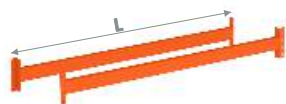

SERIE **170 L 19**

Juego de dos  
 Un jeu de deux  
 Two units

25 Kg

**L** 1900mm

SERIE **170 L 27**

Juego de dos  
 Un jeu de deux  
 Two units

27 Kg

**L** 2700mm

SERIE **TAP**  
 Protección inferior  
 Protection inférieure  
 Bottom protection

TAP-10930 TAP-35017  
 TAP-10931 TAP-10000  
 TAP-10933 TAP-35050  
 TAP-35019 TAP-10936

SERIE **170 M 30**

Juego de dos  
 Un jeu de deux  
 Two units

23 Kg

SERIE **170 BASE**

Juego de dos  
 Un jeu de deux  
 Two units



SERIE **170 ACC 08**

Juego de accesorios  
 Jeu d'accessoires  
 Accessory set

8,5 Kg

**F** 800mm

INCLUYE  
 Riestras galvanizadas;  
 (P800-P1000)  
 Separadores y tornillería.  
 COMPREND  
 Supports galvanisés;  
 (P800-P1000)  
 Séparateurs et vis.

INCLUDES  
 Galvanized supports;  
 (P800-P1000)  
 Dividers and screws.



SERIE **170 ACC 10**

Juego de accesorios  
 Jeu d'accessoires  
 Accessory set

10 Kg

**F** 1000mm

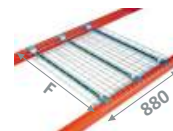

SERIE **TAP-09012**

Plataforma  
 Plateformes  
 Platforms

8,5 Kg

**F** 800mm

SERIE **TAP-09001**

Plataforma  
 Plateformes  
 Platforms

10 Kg

**F** 1000mm

SERIE **171**

Estanterías metálicas ligeras con tornillos.  
Étagères légères métalliques avec vis.  
Lightweight metal shelves with screws.



SERIE **171 10**

SERIE **171 15**

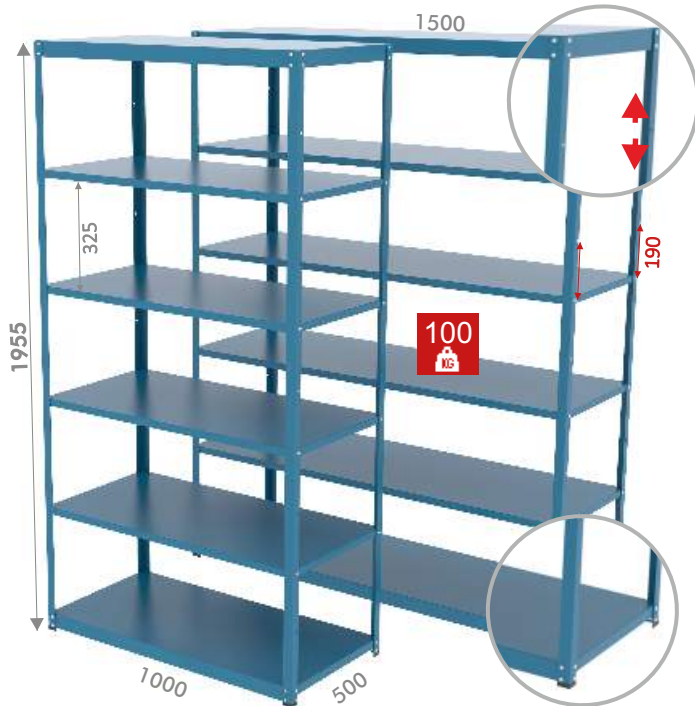

Bandejas graduables cada 190mm.  
Plateaux réglables chaque de 190 mm.  
Adjustable trays every 190mm.

**4** Bandejas incluidas.  
Plateaux réglables compris.  
Adjustable trays including.



SERIE **171 10 G**

SERIE **171 15 G**

Recubrimiento plástico en los extremos de las patas.  
Les extrémités des pieds ont un revêtement plastique.  
The foot ends included a plastic coating.

Apoyo al suelo.  
Soutien au sol.  
Floor support.



Gama de producto  
Gamme de produits  
Product range

PINTADO: Azul martelé.  
PEINTURE : Bleu martelé.  
PAINTING: Blue hammered.

Acero galvanizado.  
Acier galvanisé.  
Galvanized steel.

SERIE **171 10**

42,13 Kg  
4u. 171 10 BG

SERIE **171 15**

58,65 Kg  
4u. 171 15 BG

SERIE **171 10 G**

42,13 Kg  
4u. 171 10 BG G

SERIE **171 15 G**

58,65 Kg  
4u. 171 15 BG G

Accesorios opcionales  
Accessoires optionnels  
Optional accessories

SERIE **171 R**

Ø 50 mm  
H 65 mm



OPCIÓN: Ruedas.  
OPTION: Roues.  
OPTION: Wheels. **40**

**HT 1995mm**

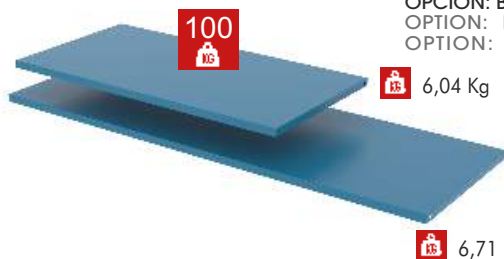

OPCIÓN: Bandejas graduables.  
OPTION: Plateaux réglables.  
OPTION: Adjustables trays.

**6,04 Kg**  
SERIE **171 10 BG**  
SERIE **171 15 BG**

**6,71 Kg**  
SERIE **171 10 BG G**  
SERIE **171 15 BG G**



SE SIRVE DESMONTADO. Montaje con tornillos, incluidos.  
SERVI DÉMONTÉ. Assemblage avec vis, inclus.  
SERVED DISASSEMBLED. Assembly with screws, included.

SERIE **222-223**

WWW

Armario para mostradores (ejemplo de composición).  
 Armoire de comptoir (exemple de composition).  
 Counter cabinet (example of composition).

Accesorios opcionales  
 Accessoires optionnels  
 Optional accessories

SERIE **222**



Divisiones opcionales.  
 Divisions optionnelles.  
 Optional divisions.

SERIE **223**



SERIE **222 2**

30,26 Kg

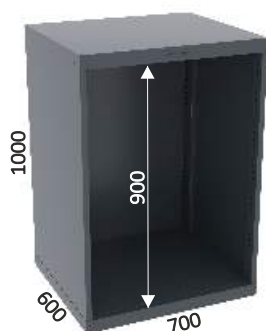

SERIE **223 2**

37,57 Kg

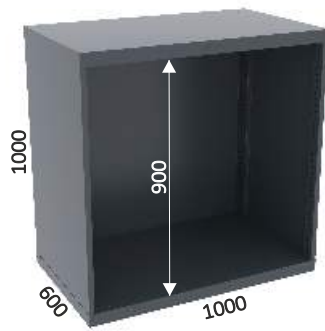

Consultar plazo de entrega.  
 Consulter le délai de livraison.  
 Check delivery time.

No incluye sistema antivuelco.  
 Ne comprend pas le système anti-renversement.  
 Does not include anti-roll system.

RAL 3020 /  
 RAL 7016



SERIE **222**

SERIE 222 BG

3,63 Kg



SERIE 222 BE T50

6,07 Kg

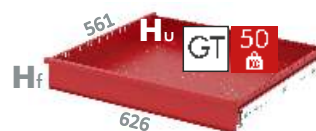

SERIE 222 T50 C75

7,12 Kg

Hf 75mm Hu 40mm

SERIE 222 T50 C100

7,87 Kg

Hf 100mm Hu 65mm

SERIE 222 T50 C125

8,62 Kg

Hf 125mm Hu 90mm

SERIE 222 T50 C200

9,00 Kg

Hf 200mm Hu 165mm

SERIE **223**

SERIE 223 BG

5,22 Kg



SERIE 223 BE T50

7,67 Kg

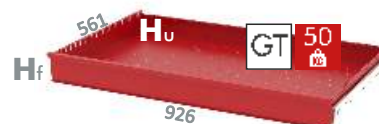
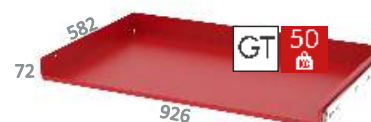

SERIE 223 T50 C75

8,02 Kg

Hf 75mm Hu 40mm

SERIE 223 T50 C100

8,77 Kg

Hf 100mm Hu 65mm

SERIE 223 T50 C125

9,52 Kg

Hf 125mm Hu 90mm

SERIE 223 T50 C200

9,90 Kg

Hf 200mm Hu 165mm

OPCIÓN: Divisiones en acero galvanizado.  
 OPTION: Separations en acier galvanisé.  
 OPTION: Galvanized steel divisions.

**SERIE 161**

**WWW** Armario 2 puertas con bandejas.  
Armoire 2 portes et plateaux.  
2 door cabinet with trays.

**i** Según normativa STAWA-R.  
Selon normative STAWA-R.  
As per STAWA-R regulations.



**SERIE 161 1**

**i** 105,5 Kg  
**e** 1 mm

**3u. 161 BG 1**  
Bandeja regulable.  
Plateau réglable.  
Adjustable tray.

**e** 2 mm

**1u. 161 BC 1**  
Bandeja colectora de líquidos.  
Plateau collecteur de liquides.  
Tray for liquid collection.

**e** 3 mm

**161 BG 1**  
**i** 10 Kg

Orificio para la extracción Ø75 mm.  
Orifice d'extraction Ø75 mm.  
Extraction hole Ø75 mm.

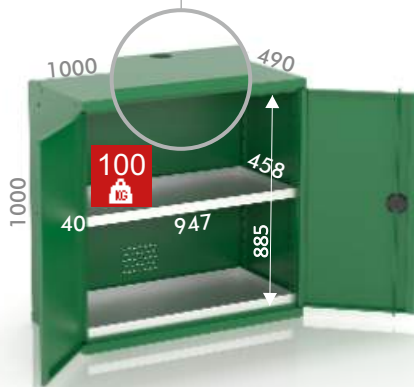

**SERIE 161 2**

**i** 59 Kg  
**e** 1 mm

**1u. 161 BG 1**  
Bandeja regulable.  
Plateau réglable.  
Adjustable tray.

**e** 2 mm

**1u. 161 BC 1**  
Bandeja colectora de líquidos.  
Plateau collecteur de liquides.  
Tray for liquid collection.

**e** 3 mm

**161 BG 1**  
**i** 10 Kg

Bandeja zincada, orificio de ventilación.  
Bac zingué, orifice d'aération.  
Zinc-coated, holes of ventilation.

ADHESIVO FITOSANITARIO.  
ADHÉSIF PHYTOSANITAIRE.  
PHYTOSANITAIRE ADHESIVE.



161 ES

161 FR

UNIDAD DE EXTRACCIÓN DE AIRE.  
UNITÉ D'EXTRACTION D'AIR.  
AIR EXTRACTION UNIT.



SIN ventilador.  
SANS ventilateur.  
WITHOUT fan.

**D-2.00.360**

**i** 2 Kg



**SERIE 161 3**

**i** 82 Kg  
**e** 1 mm

**3u. 161 BG 3**  
Bandeja regulable.  
Plateau réglable.  
Adjustable tray.

**e** 2 mm

**1u. 161 BC 3**  
Bandeja colectora de líquidos.  
Plateau collecteur de liquides.  
Tray for liquid collection.

**e** 3 mm

**161 BG 3**  
**i** 8 Kg



**SERIE 161 4**

**i** 61 Kg  
**e** 1 mm

**3u. 161 BG 4**  
Bandeja regulable.  
Plateau réglable.  
Adjustable tray.

**e** 2 mm

**1u. 161 BC 4**  
Bandeja colectora de líquidos.  
Plateau collecteur de liquides.  
Tray for liquid collection.

**e** 3 mm

**161 BG 4**  
**i** 6 Kg



CON ventilador.  
AVEC ventilateur.  
WITH fan.

**D-2.00.340**

**i** 10 Kg



**RAL 6029** NO APTOS PARA PRODUCTOS INFLAMMABLES Y EXPLOSIVOS.  
NE CONVIENT PAS AUX PRODUITS INFLAMMABLES ET EXPLOSIFS.  
NOT SUITABLE FOR FLAMMABLE AND EXPLOSIVE PRODUCTS.

**SERIE 130**

**WWW** Armarios para productos de primeros auxilios y/o de farmacia.  
Armoires pour produits de premier secours et/ou de pharmacie.  
Cabinets for first-aid or pharmaceutical products.

ARMARIOS - BOTIQUÍN  
ARMOIRES DE PREMIER SECOURS  
FIRST-AID CABINETS



**SERIE 130 1**

**i** 5,5 Kg  
**1** Estante  
Étagère  
Shelf



**SERIE 130 2**

**i** 8 Kg  
**2** Estantes  
Étagères  
Shelves

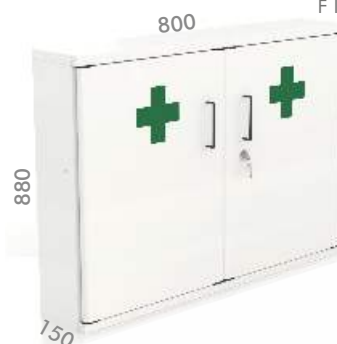

**SERIE 130 3**

**i** 22 Kg  
**2** Estantes  
Étagères  
Shelves

**e** 0,6 mm

**RAL 9010**



Bandejas interiores fijas / Asa para fácil abertura.  
Plateaux intérieurs fixes / Poignée pour faciliter l'ouverture.  
Fixed inner trays / Easy opening handle.

SERIE **304**

Bancos en acero inoxidable  
 Bancs de vestiaire en acier inoxydable  
 Stainless-steel benches

**e** 1,5 mm

WWW



□ 40x40x1,5 mm

AISI 304 L

**e** 1,5-2 mm



Consultar plazo de entrega.  
 Consulter le delai de livraison.  
 Check delivery time.

SERIE **304 BV 20**

**e** 11 Kg

SERIE **304 BV 15**

**e** 14,75 Kg

SERIE **304 BV 10**

**e** 18,5 Kg

Bancos de trabajo en acero inoxidable  
 Établis de travail en acier inoxydable  
 Stainless-steel workbenches

**e** 2 mm



SERIE **304 BT 30**

**e** 46 Kg

SERIE **304 BT 20**

**e** 60 Kg

SERIE **304 BT 15**

**e** 100 Kg



Encimera.  
 Plan de travail.  
 Worktop.

**e** 44 mm

Armario vestuario en acero inoxidable  
 Armoire vestiaire en acier inoxydable  
 Stainless-steel lockers

**e** 1 mm

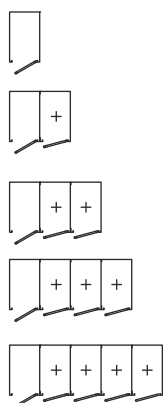

SERIE **304 1**

**e** 30,3 Kg L 310mm

SERIE **304 1 2**

**e** 60,6 Kg L 620mm

SERIE **304 1 3**

**e** 90,9 Kg L 930mm

SERIE **304 1 4**

**e** 121,2 Kg L 1240mm

SERIE **304 1 5**

**e** 151,5 Kg L 1550mm

**e** 1u. Bandeja perchero  
 1u. Plateau porte-manteau  
 1u. Clothes rack tray



SERIE **304 2**

**e** 30,6 Kg L 310mm

SERIE **304 2 2**

**e** 61,2 Kg L 620mm

SERIE **304 2 3**

**e** 91,8 Kg L 930mm

SERIE **304 2 4**

**e** 122,4 Kg L 1240mm

SERIE **304 2 5**

**e** 153 Kg L 1550mm

**e** 2u. Bandeja perchero  
 2u. Plateau porte-manteau  
 2u. Clothes rack tray

**SERIE 304**

 Armarios en acero inoxidable  
 Armoires en acier inoxydable  
 Stainless-steel cabinets

**SERIE 304 3**

85 Kg

**SERIE 304 3 TI**

85 Kg

**SERIE 304 4**

74 Kg

**SERIE 115 C - 122 C**

 Armario esquinero con y sin puertas (H:1000mm).  
 Armoire d'angle avec ou sans porters (H:1000 mm).  
 Corner cabinet with or without doors (H:1000 mm).



**SERIE 115 C**

47 Kg

 1 m<sup>3</sup>

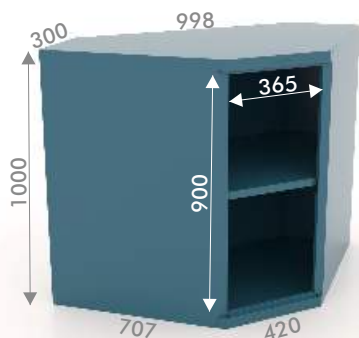
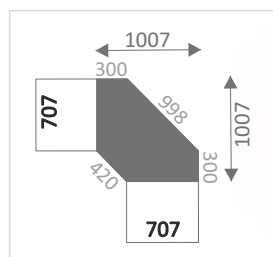
 sin puertas  
sans portes  
without doors

 OPCIÓN: Puerta.  
 OPTION: Porte.  
 OPTION: Door.

**SERIE 115 CP**

44 Kg

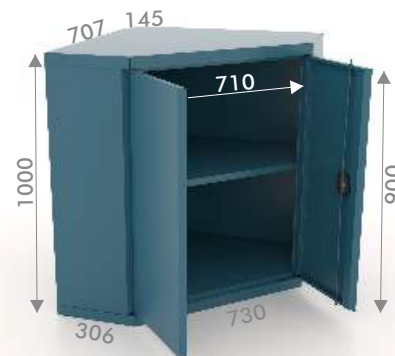
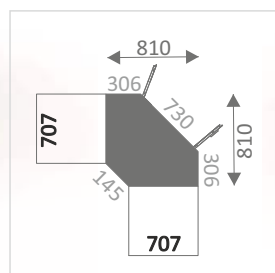
 0,651 m<sup>3</sup>

 con puertas  
avec portes  
with doors

**SERIE 122 C**

40 Kg

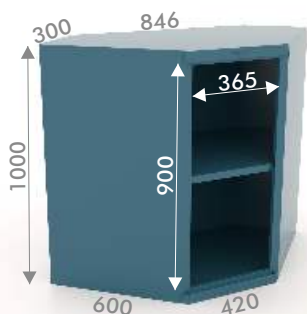
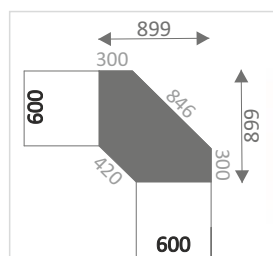
 0,804 m<sup>3</sup>

 sin puertas  
sans portes  
without doors

 OPCIÓN: Puerta.  
 OPTION: Porte.  
 OPTION: Door.

**SERIE 122 CP**

38 Kg

 0,651 m<sup>3</sup>

 con puertas  
avec portes  
with doors
