



SERIE 139

SERIE 140

SERIE 128

SERIE 134



SERIE V-CONT 45
SERIE V-CONT 50

SERIE 114 M

SERIE M7

SERIE 145 R

SERIE 151

accesorios
accessoires
accessories

SERIE 149 0 01



SERIE 149 0 02



SERIE 149 0 03



SERIE 149 0 04



SERIE ISO 40/50



SERIE VDI 40

SERIE HSK 50/63/80/100



SERIE CAPTO 8

SERIE V-BULL 1



SERIE CE P 1

SERIE V-BULL 2



SERIE V-BULL 3

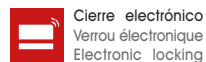



información
information
information



Cierre con llave.
Fermeture à clé.
Key Locking.



Interior cajón ranurado.
Intérieur tiroir rainurée.
Interior slotted drawer.



Sistema antivuelco.
Système anti-renversement.
Anti-roll system.

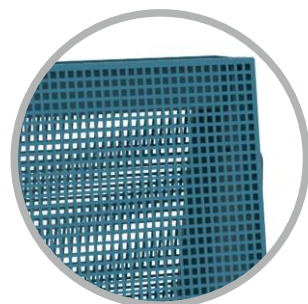

Panel perforado.
Panneau perforé.
Perforated panel.

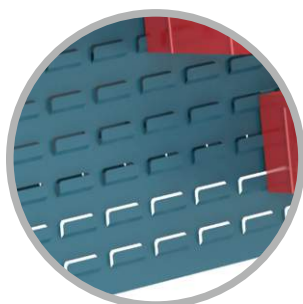

Panel porta cubetas.
Panneau pour bacs à bec.
Tray-holder panel.

- [ES]**
- Carros de trabajo y de taller.
 - Varias opciones de almacenaje, según necesidad.
 - Opción porta conos (ISO, CAPTO, VDI y HSK).
 - Ruedas de goma Ø75 - 100 mm (según modelo).
 - Carga máxima: 100 kg (excepto serie 134 > 240 Kg).
 - Panel perforado: chapa 1,5 mm.
 - Panel porta cubetas: chapa 1,2 mm.
 - Armazón: chapa 1 mm.
 - Asa en cada lateral para facilitar el transporte.
 - Color estándar azul martelé posibilidad colores en opción.

- [FR]**
- Desserte de travail et servante d'atelier.
 - Plusieurs options de rangement selon besoin.
 - Option porte-cônes (ISO, CAPTO, VDI et HSK).
 - Roues en caoutchouc Ø75 - 100 mm (selon le modèle).
 - Charge maximale: 100 kg (sauf série 134 > 240 kg).
 - Panneaux perforés: épaisseur 15/10 mm.
 - Panneau bacs à bec: épaisseur 12/10 mm.
 - Châssis: Tôle 15/10 mm.
 - Double poignée laterale pour faciliter le transport.
 - Couleur standard bleu martelé possibilité teintes en option.

- [EN]**
- Workshop trolleys with trays for storage.
 - Several storage options according to need.
 - Optional tool-holders (ISO, CAPTO, VDI and HSK).
 - Perforated panels: 1,5 mm metal sheet.
 - Tray-holder panels: 1,2 metal sheet.
 - Frame: 1 mm metal sheet.
 - Rubber wheels, Ø75 - 100 mm (depending on model).
 - Maximum load: 100kg (except serie 134 > 240kg).
 - Handle feach for easy transport.
 - Standard colour hammered blue possibility optional colours.

SERIE 139

Asa para una manipulación fácil.
Poignée pour une manipulation facile.
Handle for easy handling.

Estructura desmontable.
Structure amovible.
Removable structure.

e 2 mm



Bandejas fijas.
Plateaux fixes.
Fixed shelves.

e 1 mm

Carro con bandejas estándar.
Desserte avec plateaux standard.
Trolley with standard trays.

SERIE 139 1

KG 14,5 Kg
470 x 145 x 715 mm
Ø 75 mm
H 100 mm

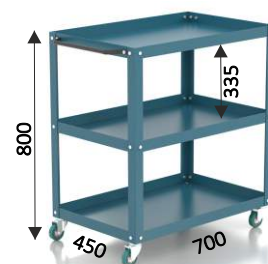

SERIE 139 2

KG 18,5 Kg
490 x 145 x 815 mm
Ø 75 mm
H 100 mm

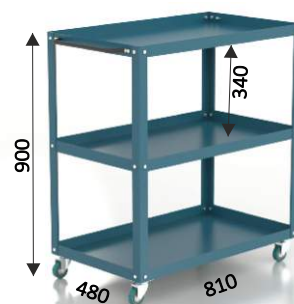

100 KG Carga total repartida
Charge totale répartie
Distributed total load

Montaje con tornillos, incluidos.
Assemblage avec vis, inclus.
Assembly with screws, included.

SERIE 140

Disponibile con cajón bidireccional.
Possibilité avec tiroir bidirectionnel.
Be able with bidirectional drawer.

Doble asa.
Double poignée
Double handle.



Bandejas fijas.
Plateaux fixes.
Fixed shelves.

e 0,8 mm

Estructura soldada y esquinas redondeadas.
Structure soudée et angles arrondies.
Welded structure and rounded edges.

e 3 mm

Carro de trabajo con bandejas y cajón opcional.
Desserte de travail avec plateaux et tiroir optionnel.
Workshop trolley with trays and optional drawer.

SERIE 140 1

KG 13,8 Kg
660 x 380 x 850 mm
Ø 75 mm
H 100 mm

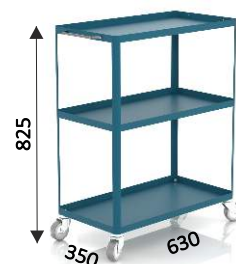

SERIE 140 2

KG 16,55 Kg
800 x 440 x 840 mm
Ø 75 mm
H 100 mm

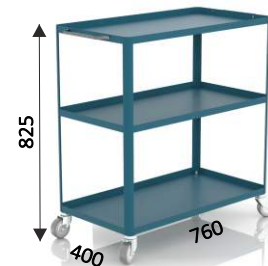

SERIE 140 3

KG 16,5 Kg
800 x 440 x 840 mm
Ø 75 mm
H 100 mm
i cajón bidireccional
tiroir bidirectionnel
bidirectional drawer

100 KG Carga total repartida
Charge totale répartie
Distributed total load

SERIE 146

Carro con bandejas y soporte porta rollo.
Desserte avec plateaux et support de rouleur.
Workshop trolley with trays and roll holder accessory.



Bandejas fijas.
Plateaux fixes.
Fixed shelves.

e 0,6 mm

Estructura soldada y esquinas redondeadas.
Structure soudée et angles arrondies.
Welded structure and rounded edges.

e 3 mm

SERIE 146 1

KG 21,54 Kg
805 x 430 x 1020 mm
Ø 75 mm
H 100 mm



SERIE 146 2

KG 29,29 Kg
805 x 430 x 1020 mm
Ø 75 mm
H 100 mm



SERIE 108 7

KG 20.2 L

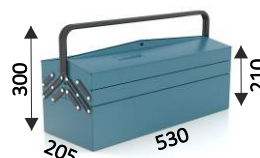

100 KG Carga total repartida
Charge totale répartie
Distributed total load

SERIE 134

www

Carro de alta resistencia con bandejas o portaconos ISO/HSK/VDI/CAPTO.
Desserte haute résistance avec plateaux ou porte-cônes ISO/HSK/VDI/CAPTO.
Heavy duty workshop trolley with trays or tool-holders (ISO/HSK/VDI/CAPTO).

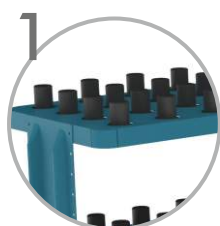

1
Bandejas portaconos.
Plateau porte-cônes.
Tool-holder trays.

e 2 mm

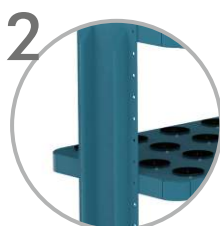

2
Estructura soldada.
Structure soudée.
Welded structure.

e 3 mm



3
Goma sintética estriada.
Coutchouc synthétique strié.
Synthetic rubber striated.

e 3 mm



4
Ruedas de goma.
Roues en coutchouc.
Rubber wheels.

KG Ø100mm

SERIE **134**

Accesorios
Accessoires
Accessories

SERIE 134 BC
bandeja - cajón
plateau - tiroir
tray - drawer

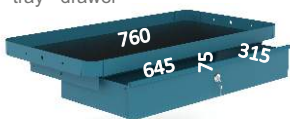

i Graduables cada 45 mm.
Réglables chaque 45 mm.
Adjustable every 45 mm.

BADEJAS PORTACONOS
PLATEAU PORTE-CÔNES
TOOL-HOLDER TRAYS



PORTACONOS ISO 40/50
PORTE-CÔNES - TOOL-HOLDER
VDI 40



SERIE **134 1**

KG 32,4 Kg



SERIE **134 2**

KG 35 Kg

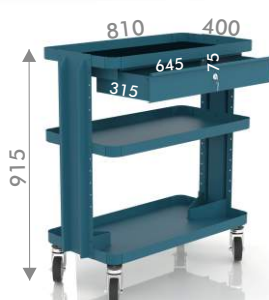

SERIE **134 BG**

KG 6,2 Kg



SERIE **134 BC**

KG 8,7 Kg



SERIE **134 ISO 40**

KG 32,4 Kg
40x ISO 40
134 BG
134 B ISO 40



SERIE **134 ISO 50**

KG 32,4 Kg
30x ISO 50
134 BG
134 B ISO 50



SERIE **134 B ISO 40**

KG 4,6 Kg
24x ISO 40

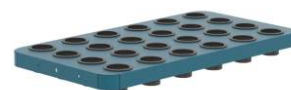

SERIE **134 B ISO 50**

KG 4,2 Kg
18x ISO 50

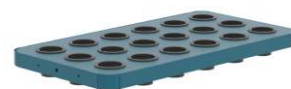

SERIE **134 HSK 50**

KG 32,4 Kg
40x HSK 50
134 BG
134 BHSK 50



SERIE **134 HSK 63**

KG 32,4 Kg
40x HSK 63
134 BG
134 BHSK 63



SERIE **134 BHSK 50**

KG 4,2 Kg
24x HSK 50



SERIE **134 BHSK 63**

KG 4,2 Kg
24x HSK 63



SERIE **134 HSK 80**

KG 32,4 Kg
30x HSK 80
134 BG
134 BHSK 80



SERIE **134 HSK 100**

KG 32,4 Kg
30x HSK 100
134 BG
134 BHSK 100



SERIE **134 BHSK 80**

KG 4,2 Kg
24x HSK 80

SERIE **134 BHSK 100**

KG 4,2 Kg
18x HSK 100



SERIE 114

SERIE 114 1

 23,94 Kg



Soportes soldados.
Supports soudées.
Supports welded.

Incluye cajón y bandeja fija.
Tiroir et plateau fixe inclus.
Included drawer and fixed tray.

Capacidad 118 herramientas.
Capacité 118 outils.
Capacity 118 tools.



SERIE 114 2

 25,42 Kg



Incluye cajón y bandeja fija.
Tiroir et plateau fixe inclus.
Included drawer and fixed tray.

2 bandejas graduables y 1 fija.
2 plateaux réglables et 1 fixe.
2 regulables trays and 1 fixed.



SERIE 114 P

 19 Kg



Soportes soldados.
Supports soudées.
Supports welded.

Incluye cajón y bandeja fija.
Tiroir et plateau fixe inclus.
Included drawer and fixed tray.

Capacidad 118 herramientas.
Capacité 118 outils.
Capacity 118 tools.

Panel perforado en fondo y laterales.
Panneau perforé en postérieur et latéraux.
Perforated panel in front and besides.



SERIE 114 C

 21 Kg



Soportes soldados.
Supports soudées.
Supports welded.

Incluye cajón y bandeja fija.
Tiroir et plateau fixe inclus.
Included drawer and fixed tray.

Cubetas: 10u. V-BULL 1 - 15u. V-BULL 2.
Bacs à bec: 10u. V-BULL 1 - 15u. V-BULL 2.
Trays: 10u. V-BULL 1 - 15u. V-BULL 2.



SERIE 114 M

Componentes
Composants
Components

CARRO CHARIOT / TROLLEY

SERIE 114 M 01

 25,54 Kg

 2 mm

1x 134 BG
bandeja graduable
plateau réglable
adjustable tray

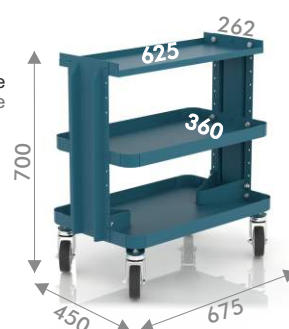

Ruedas de goma giratorias
Roues en caoutchouc pivotant
Rotating rubber wheels



ARMARIO ARMOIRE / CABINET

SERIE 114 1

 23,94 Kg

 1 mm

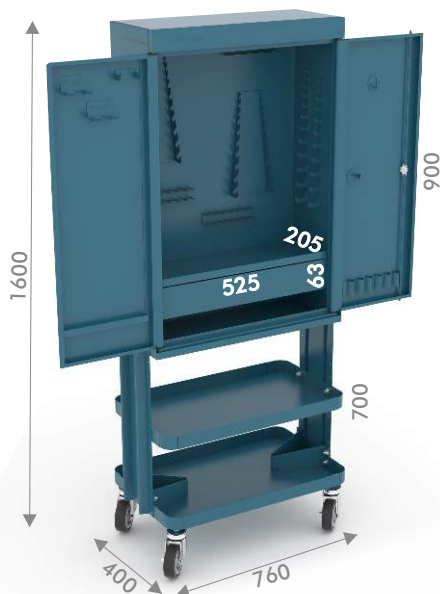
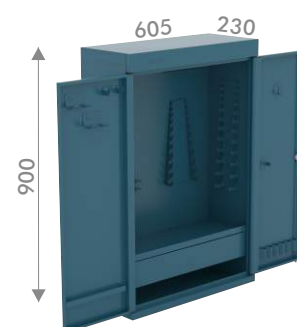

SERIE 114 M

 49,48 Kg

114 M 01
114 1



SERIE CE P 1

Cierre electrónico
Verrou électronique
Electronic locking



Opción
Option
Option

SERIE CE P 1
SERIE CE P 1 LL
SERIE CE P 1 TM
SERIE CE P 1 TU

SERIE 128

Carro de alta resistencia para trabajos de exteriores.
Chariot haute résistance pour les travaux en extérieurs.
Heavy duty workshop trolley for outdoor work.



SERIE 128

46 Kg

Asa y portadocumentos.
Poignée et porte-documents.
Handle and document holder.



Estructura y ruedas.
Châssis et roues.
Frame and wheels.

1,5 mm
 Ø125

Bandeja.
Plateau.
Shelf.

2 mm

Chapa perforada.
Tôle perforée.
Perforated sheet.

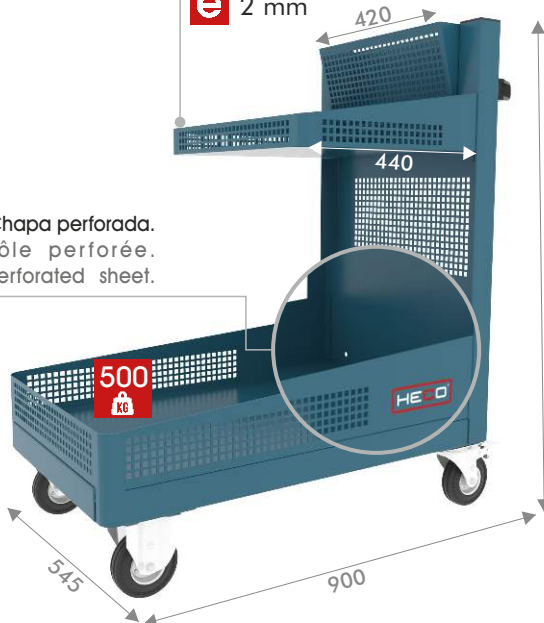

SERIE 128 pack 1

54 Kg
1x SERIE 138 4 SA



SERIE 128 pack 2

59 Kg
1x SERIE 138 4 SA
1x SERIE 102 7

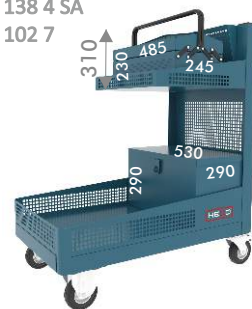

Consultar plazo de entrega.
Consulter le délai de livraison.
Check delivery time.

El candado para el arcón no se suministra.
La serrure du coffre n'est pas fournie.
The lock for the chest is not supplied.

SERIE 116

Cierre con persiana y cajones con guías ranuradas cada 14 mm.
Fermeture à rideau et tiroirs avec glissières rainurées chaque 14 mm.
Shutter closure and drawers with grooved slides every 14 mm.



SERIE 116 1

34,7 Kg

Incluye 2 bandejas fijas.
2 plateaux fixes inclus.
Included 2 fixed trays.

SERIE 116 2 01
División cajón
Séparation tiroir
Division drawer

Persiana ambos lados.
Rideau deux côtés.
Shutter both sides.

Cada cajón incluye dos divisiones.
Chaque tiroir inclus deux séparations.
Each drawer included two divisions.

15 KG

240 KG



Cierre a la izquierda.
Verrouillage à gauche.
Left-hand locking.

1 mm

SERIE 116 3

42,3 Kg

Incluye 4 cajones.
2 Tiroirs inclus.
Included 2 drawers.

SERIE 116 2 01
División cajón
Séparation tiroir
Division drawer

Persiana un lado.
Rideau un côté.
Shutter one side.



Ruedas de goma
Roues en caoutchouc
Rubber wheels

Ø 100 mm
H 135 mm

Cierre centralizado con llave (bloqueo persiana).
Verrouillage centralisé avec clé (verrouillage rideau).
Central locking with key (shutter blocking).

SERIE 117

www

Carro con cajones de diferentes composiciones.
Servante avec tiroirs de différentes compositions.
Trolley with drawers of different compositions.

Cada cajón incluye tres divisiones.
Chaque tiroir inclus trois séparations.
Each drawer included three divisions.



Ruedas de goma
Roues en caoutchouc
Rubber wheels

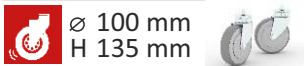

Cierre a la derecha.
Verrouillage à droite.
Right-hand locking.

e 1 mm

SERIE 117 0

KG 49,8 Kg
i Incluye 4 cajones.
2 Tiroirs inclus.
Included 2 drawers.
Divisiones cajones
Séparations tiroirs
Divisions drawers
2x 117 S15 C55
1x 117 S15 C110
1x 117 S15 C440
SERIE 117 001
SERIE 117 002

SERIE 117 1

KG 49,8 Kg
i Incluye 5 cajones.
5 Tiroirs inclus.
Included 5 drawers.
Divisiones cajones
Séparations tiroirs
Divisions drawers
2x 117 S15 C55
1x 117 S15 C110
2x 117 S15 C220
SERIE 117 001
SERIE 117 002
SERIE 117 003

SERIE 117 2

KG 51 Kg
i Incluye 6 cajones.
6 Tiroirs inclus.
Included 6 drawers.
Divisiones cajones
Séparations tiroirs
Divisions drawers
2x 117 S15 C55
3x 117 S15 C110
1x 117 S15 C220
SERIE 117 001
SERIE 117 002
SERIE 117 003

SERIE 117 3

KG 53,3 Kg
i Incluye 8 cajones.
8 Tiroirs inclus.
Included 8 drawers.
Divisiones cajones
Séparations tiroirs
Divisions drawers
4x 117 S15 C55
4x 117 S15 C110
SERIE 117 001
SERIE 117 002

SERIE M 7

www

Carro para taller de alta resistencia.
Servante d'atelier de haute résistance.
Heavy duty workshop trolley.

SERIE 122 M 7

KG 170 Kg
3u. SERIE 122 S100 C75
2u. SERIE 122 S100 C100
1u. SERIE 122 S100 C125
1u. SERIE 122 S100 C150

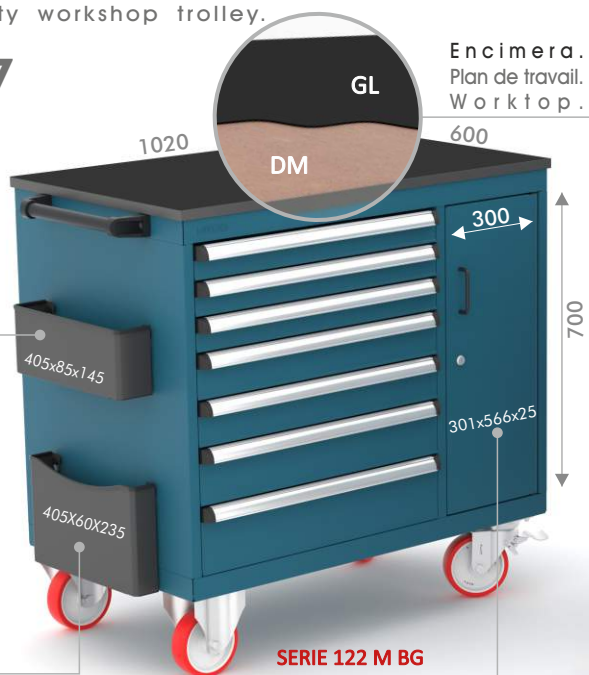

SERIE 122 2 M 01
Portaesprais.
Porte-sprays.
Sprays-holder.

SERIE 122 2 M 02
Portadocumentos.
Porte-documents.
Document-holder.

SERIE 122 M BG
Bandeja graduable.
Plateau réglable.
Adjustable tray.

Cajones.
Tiroirs.
Drawers.

SERIE 135 M 7

KG 137,5 Kg
3u. SERIE 135 S100 C75
2u. SERIE 135 S100 C100
1u. SERIE 135 S100 C125
1u. SERIE 135 S100 C150

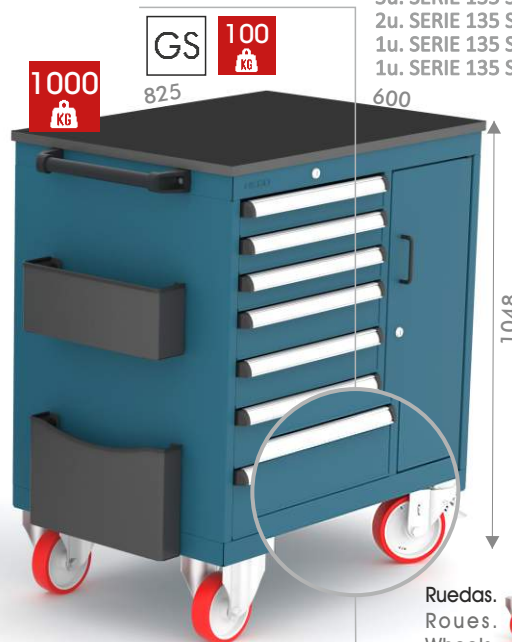

Ruedas.
Roues.
Wheels.



i Cierre centralizado con llave (1 sola llave) y superficie superior antideslizante. Pirelli 14mm.
Verrouillage centralisé avec clé (une unique clé) et Surface supérieure antidérapante. Pirelli 14mm.
Central locking with only one key and Nonslip top surface. Pirelli 14mm.

i Composición estándar con 7 cajones.
Composition standard avec 7 tiroirs.
Standard composition with 7 drawers.

SERIE 148

Carro de trabajo robusto, multicajones con accesorios opcionales.
 Servante d'atelier robuste, multi tiroirs et accessoires optionnels.
 Robust workshop trolley, multi-drawers and optional accessories.



Encimera ABS.
 Plan de travail ABS.
 Worktop ABS.

Sistema antivuelco.
 Système anti-renversement.
 Anti-roll system.

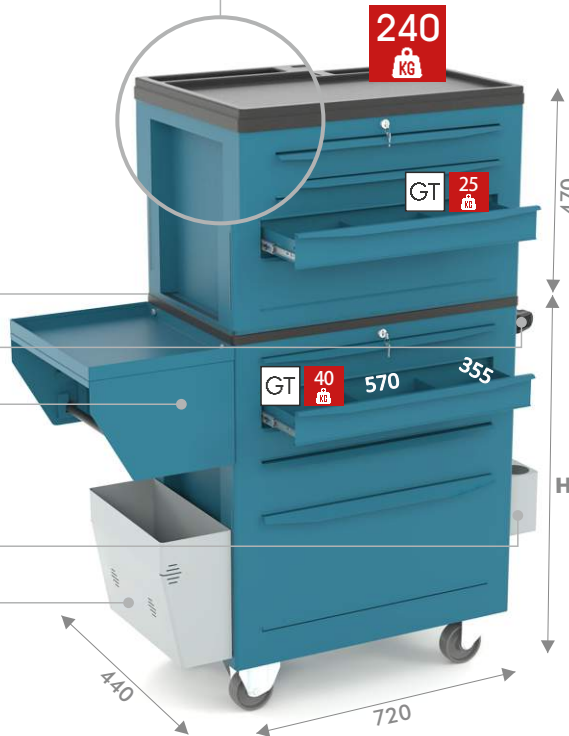

SERIE 148 C 3

34 Kg
 3u. SERIE 148 T25 C116



SERIE 149 0 04

A s a
 Poignée
 Handle
 1 Kg

SERIE 149 0 01

Portarollos
 Porte-rouleau
 Roll-holder
 3,5 Kg

SERIE 149 0 03

Portasprays
 Porte-sprays
 Spray-holder
 1,2 Kg

SERIE 149 0 02

Papelera
 Poubelle
 Garbage
 2 Kg

SERIE 148 C 4

38 Kg
 3u. SERIE 148 T25 C76
 1u. SERIE 148 T25 C116



SERIE 148 5

56 Kg H 900 mm
 3u. SERIE 148 T40 C76
 1u. SERIE 148 T40 C116
 1u. SERIE 148 T40 C270



SERIE 148 6

58 Kg H 900 mm
 3u. SERIE 148 T40 C76
 2u. SERIE 148 T40 C116
 1u. SERIE 148 T40 C146



SERIE 148 7

62 Kg H 915 mm
 5u. SERIE 148 T40 C76
 1u. SERIE 148 T40 C110
 1u. SERIE 148 T40 C116



SERIE 148 8

66 Kg H 1000 mm
 6u. SERIE 148 T40 C76
 2u. SERIE 148 T40 C116



SERIE 148 9

70 Kg H 1000 mm
 9u. SERIE 148 T40 C76



SERIE 149

www

Carro de trabajo con cajones y bandejas. Varios accesorios disponibles.
Servante d'atelier avec tiroirs et plateaux. Plusieurs accessoires disponibles.
Workshop trolley with drawers and trays. Several accessories available.

SERIE 149 1

50 Kg

3u. SERIE 149 T15 C55
1u. SERIE 149 T15 C75

Encimera ABS.
Plan de travail ABS.
Worktop ABS.

Cada cajón ambi extraible incluye dos divisiones.
Chaque tiroir amovible inclus deux séparations.
Each detachable drawer included two divisions.

0,8 mm

Ruedas de goma
Roues en caoutchouc
Rubber wheels

Ø 100 mm
H 135 mm

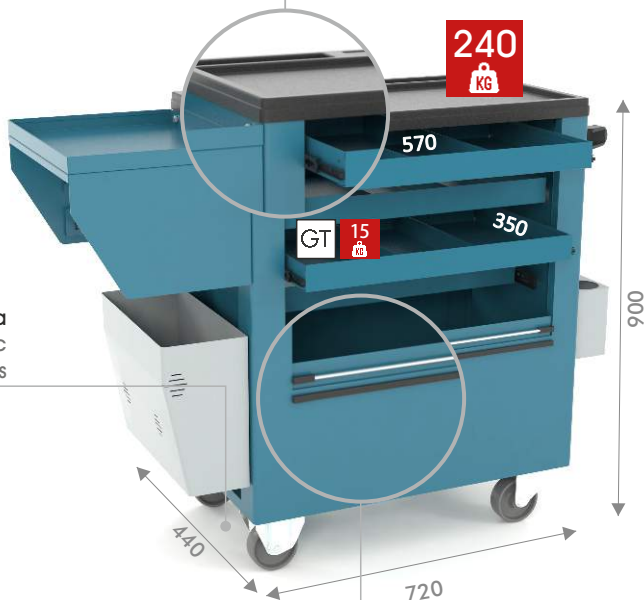

Cierre centralizado con llave. Bloqueo persiana.
Verrouillage centralisé avec clé. Verrouillage rideau.
Central locking with key. Shutter blocking.

1 mm

Accesorios opcionales
Accessoires optionnels
Optional accessories

SERIE 149 0 01

Portarrollos
Porte-rouleau
Roll-holder

6 Kg

460 x 340 x 300 mm



SERIE 149 0 02

Papelera
Poubelle
Garbage can

2 Kg

420 x 200 x 330 mm

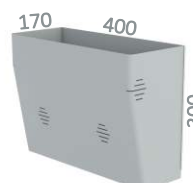

SERIE 149 0 03

Portasprays
Porte-sprays
Spray-holder

1,2 Kg

420 x 100 x 160 mm

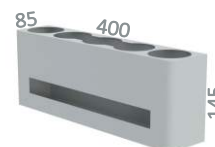

SERIE 149 0 04

Asa
Poignée
Handle

1 Kg

400 x 70 x 50 mm



SERIE M

www

Carro de trabajo con cajones. Sistema antivuelco.
Servante d'atelier avec tiroirs. Système anti-renversement.
Workshop trolley with drawers. Anti-Roll system.

Cierre centralizado.
Fermeture centralisée.
Centralized closing.

1 mm

Goma sintética estriada.
Coutchouc synthétique strié.
Synthetic rubber striated.

Ruedas de nylon de Ø100 mm.
Roues en nylon Ø100 mm.
Nylon wheels Ø100 mm.

2 mm

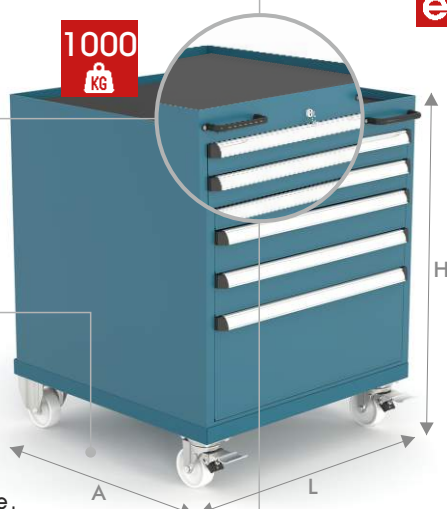

Cajones según serie.
Tiroirs selon série.
Drawers according at series.

GS 100

Guías Simples (apertura 90%)
Glissières Simples (ouverture 90%)
Simple Slides (90% opening)

No incluyen divisiones.
N'inclus pas les séparations.
Divisions for drawer no included.

SERIE 115 1 M

112 Kg

2u. SERIE 115 S100 C75
2u. SERIE 115 S100 C100
1u. SERIE 115 S100 C250

L 714 mm A 707 mm H 865 mm

SERIE 119 1 M

132 Kg

2u. SERIE 119 S100 C75
2u. SERIE 119 S100 C100
1u. SERIE 119 S100 C250

L 1020 mm A 707 mm H 865 mm

SERIE 135 0 M

63 Kg

1u. SERIE 135 S100 C75
1u. SERIE 135 S100 C100
1u. SERIE 135 S100 C150
1u. SERIE 135 S100 C200

L 515 mm A 600 mm H 790 mm

SERIE 135 1 M

75 Kg

2u. SERIE 135 S100 C75
2u. SERIE 135 S100 C100
1u. SERIE 135 S100 C250

L 515 mm A 600 mm H 865 mm

SERIE 151

- RAL 7016
- RAL 3020

Carro de trabajo con cajones diferentes modelos a escoger según las necesidades.
 Servante d'atelier avec tiroirs différents modèles à choisir en fonction des besoins.
 Workshop trolley with drawers different versions to be chosen according to the needs.



Cierre centralizado con llave.
 Verrouillage central avec clé.
 Central locking with key.

e 1 mm

Asa en ambos lados.
 Poignée de chaque côté.
 Handle on both sides.

Ruedas.
 Roues.
 Wheels.



Goma sintética estriada.
 Caoutchouc synthétique strié.
 Synthetic rubber striated.

Puerta y panel perforado.
 Porte et panneau perforé.
 Door and perforated panel.

e 0,6 mm



Cajones sin divisiones.
 Tiroirs sans les séparations.
 Drawers without divisions.

e 0,8 mm **GT** **25** KG

SERIE 151 4

- 58,93 Kg**
- 1,07 m²**
- 0,099 m³ - 99 l**

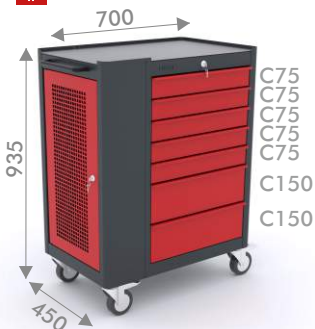

SERIE 151 5

- 43,97 Kg**
- 1,07 m²**
- 0,099 m³ - 99 l**



SERIE 151 6

- 50,36 Kg**
- 1,4 m²**
- 0,131 m³ - 131 l**



SERIE 151 7

- 42,41 Kg**
- 0,92 m²**
- 0,077 m³ - 77 l**



SERIE 151 8

- 24,68 Kg**
- 0,36 m²**
- 0,0314 m³ - 31,4 l**



SERIE 145 10 R

WWW

Panel perforado doble cara con ruedas.
Panneau perforé double face avec roues.
Double-side perforated panel with wheels.

240
KG

SERIE 145 10 R

33 Kg

Ruedas de goma.
Roues en caoutchouc.
Rubber wheels.



Con asas a ambos lados de plástico.
Avec poignées des deux côtés en plastique.
With plastic handles on both sides.

Montaje con tornillos (se entrega desmontado).
Montage avec vis (livraison démonté).
Screw assembly (supplied disassembled).

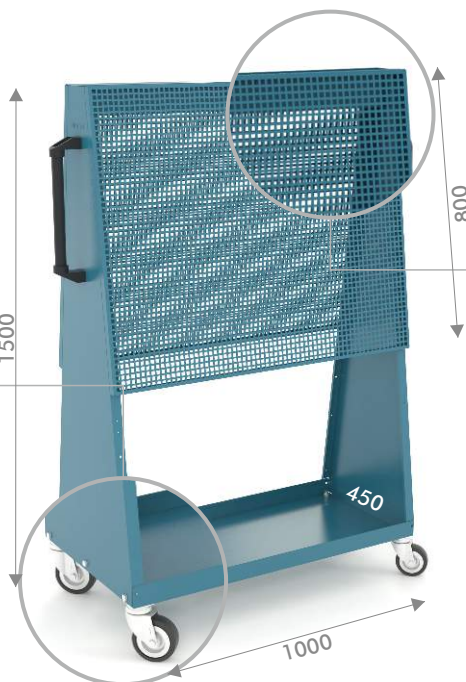

Panel perforado.
Panneau perforé.
Perforated panel.

SERIE 141 0 1 Pg. 93
Accesorios opcionales.
Accessoires optionnels.
Optional accessories.

SERIE V-CONT

WWW

Panel portacubetas doble cara con ruedas.
Panneau porte bacs a bec double face avec roues.
Double-side tray-holder panel with wheels.

400
KG

SERIE V-CONT 50 H

39,7 Kg

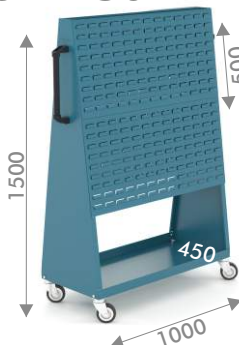

SERIE V-CONT 50 H 1

65,7 Kg

16u. V-BULL 1
32u. V-BULL 2
36u. V-BULL 3



SERIE V-CONT 50 H 2

62,7 Kg

32u. V-BULL 1
16u. V-BULL 2
36u. V-BULL 3

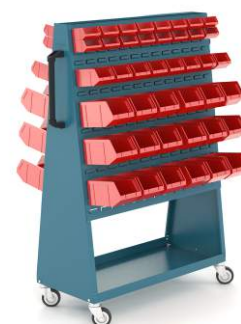

SERIE V-CONT 50 H 3

71,10 Kg

42u. V-BULL 2
36u. V-BULL 3



SERIE V-CONT 45 H

39,7 Kg

Panel porta cubetas.
Panneau pour bacs à bec.
Tray-holder panel.

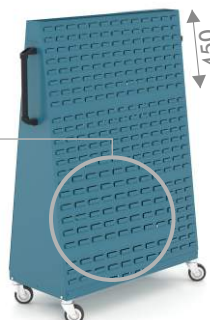

SERIE V-CONT 45 H 1

71,5 Kg

384u. V-BULL 1

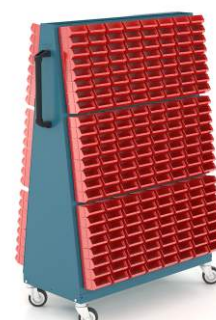

SERIE V-CONT 45 H 2

75,2 Kg

192u. V-BULL



SERIE V-CONT 45 H 3

78 Kg

108u. V-BULL 3



SERIE V-CONT 45 H 4

75 Kg

128u. V-BULL 1
64u. V-BULL 2
36u. V-BULL 3

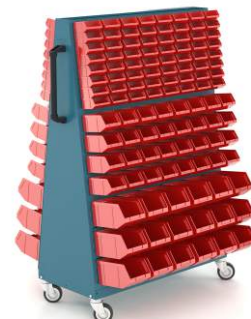

PORTA-CONOS PORTE-CÔNES TOOL SUPPORT

HSK 100

HSK 80

HSK 63

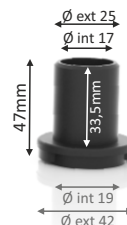
HSK 50

ISO 40

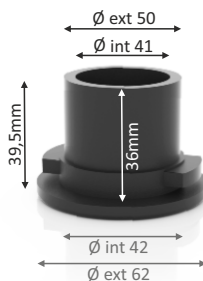
ISO 50

VDI 40

CAPTO 8

ACCESORIOS ACCESSOIRES ACCESSORIES

149 0 01

Portarollos
Porte-rouleau
Roll-holder

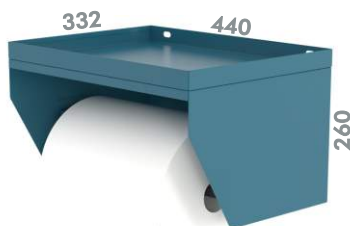
6 Kg
 460 x 340 x 300 mm

149 0 02

Papelera
Poubelle
Garbage can

2 Kg
 420 x 200 x 330 mm

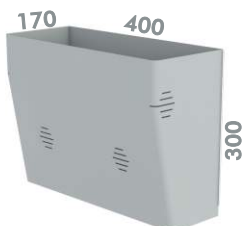
149 0 03

Portasprays
Porte-sprays
Spray-holder

1,2 Kg
 420 x 100 x 160 mm

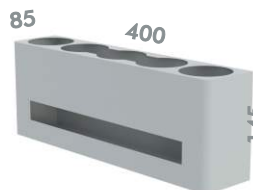
149 0 04

A s a
Poignée
Handle

1 Kg
 400 x 70 x 50 mm

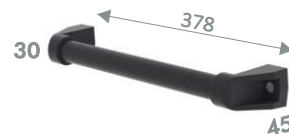

CUBETAS BACS A BEC TRAYS

V-BULL 1

2,3 Kg
 50 u
 0,4 L

V-BULL 2

5,3 Kg
 48 u
 1,2 L

V-BULL 3

8,6 Kg
 38 u
 3,5 L

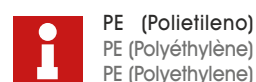

SOPORTES SUPPORTS



Soportes para fijar en paneles perforados.
Supports pour fixation en panneaux perforés.
Supports for attaching to perforated panels.

141 0 01

- Gancho
- Crochet
- Hook

5u. 10



141 0 02

- Gancho
- Crochet
- Hook

5u. 10



141 0 03

- Gancho
- Crochet
- Hook

5u. 10



141 0 04

- Gancho
- Crochet
- Hook

5u. 10



141 0 05

- Gancho
- Crochet
- Hook

5u. 10



141 0 06

- Gancho
- Crochet
- Hook

5u. 10



141 0 07

- Gancho
- Crochet
- Hook

5u. 10

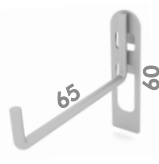

141 0 08

- Gancho
- Crochet
- Hook

5u. 10

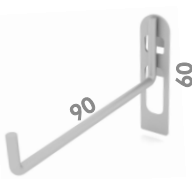

141 0 09

- Bandeja
- Plateau
- Tray

1u.

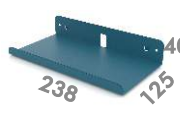

141 0 10

- Llaves vaso
- Clés douille
- Socket wrenches

1u.

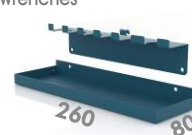

141 0 11

- Cubeta con soporte
- Casier avec support
- Bucket with support

1u.



141 0 12

- 6 destornilladores
- 6 tournevis
- 6 screwdrivers

1u.



141 0 13

- Bandeja
- Plateau
- Tray

1u.



141 0 14

- Alicates
- Pinces
- Pliers

1u.



141 0 15

- Tenazas
- Tenailles
- Tongs

1u.

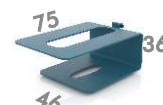

141 0 16

- Tenazas apertura múltiple
- Pinces multiprises
- Multi-opening tongs

1u.



141 0 17

- 12 llaves allen
- 12 clés mâle.
- 12 Allen keys

1u.

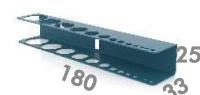

141 0 18

- 12 llaves tubo
- 12 clés tube
- 12 pipe wrenches

1u.



141 0 19

- 10 llaves acodadas
- 10 clés à fourches
- 10 angled keys

1u.



141 0 20

- 12 llaves fijas
- 12 clés à fouches
- 12 fixed keys

1u.



141 0 21

- Blister con 1 unidad
- Blister à 1 unité.
- 1 unit blister.

1u.



141 0 22

- Blister con 1 unidad
- Blister à 1 unité.
- 1 unit blister.

1u.



141 0 23

- Blister con 1 unidad
- Blister à 1 unité.
- 1 unit blister.

1u.

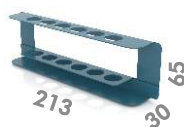

141 0 24

- Llaves bujías
- Clés à bougie
- Spark plug keys

1u.



141 0 25

- Maza o martillo
- Masse ou marteau
- Hammer or mallet

2u.



141 0 26

- Cubeta con soporte
- Casier avec support
- Bucket with support

1u.

