

SERIE 115



SERIE 119



SERIE 143

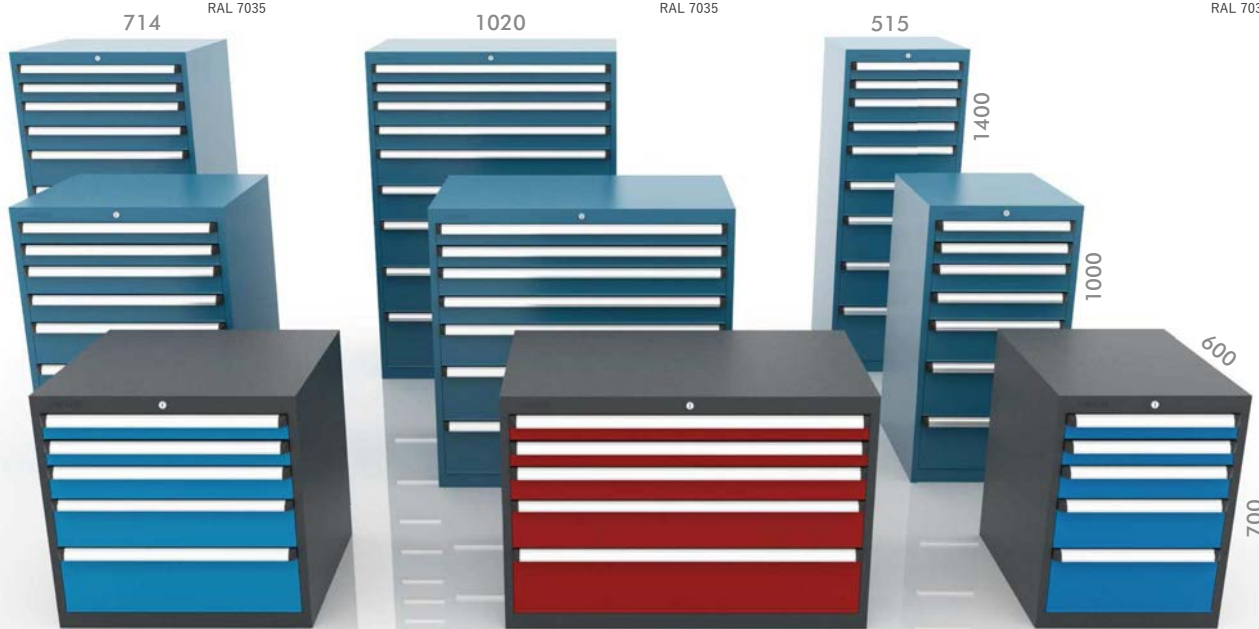

SERIE 122



SERIE 123



SERIE 135



ACCESORIOS
ACCESSOIRES
ACCESSORIES

Zócalo
Socle
Stand



Base con ruedas
Socle avec roues
Wheeled stand



Bastidor portaconos
Châssis porte-cônes
Tool holder frame

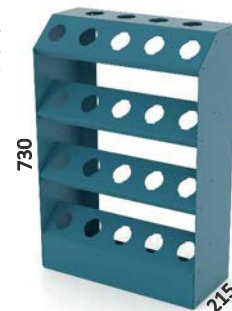

Ref. CE P 1



Suplemento encimera
Supplément plan de travail
Worktop supplement

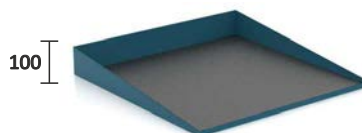

Cierre electrónico
Verrou électronique
Electronic locking

Los cajones no incluyen divisiones.
Les tiroirs n'incluent pas les séparations.
Divisions for drawers no included.

Para colores no estándar hay coste adicional (consultar condiciones).
Pour les couleurs non standard il y a un coût supplémentaire (consulter les conditions).
For non-standard colours there is an additional cost (consult conditions).

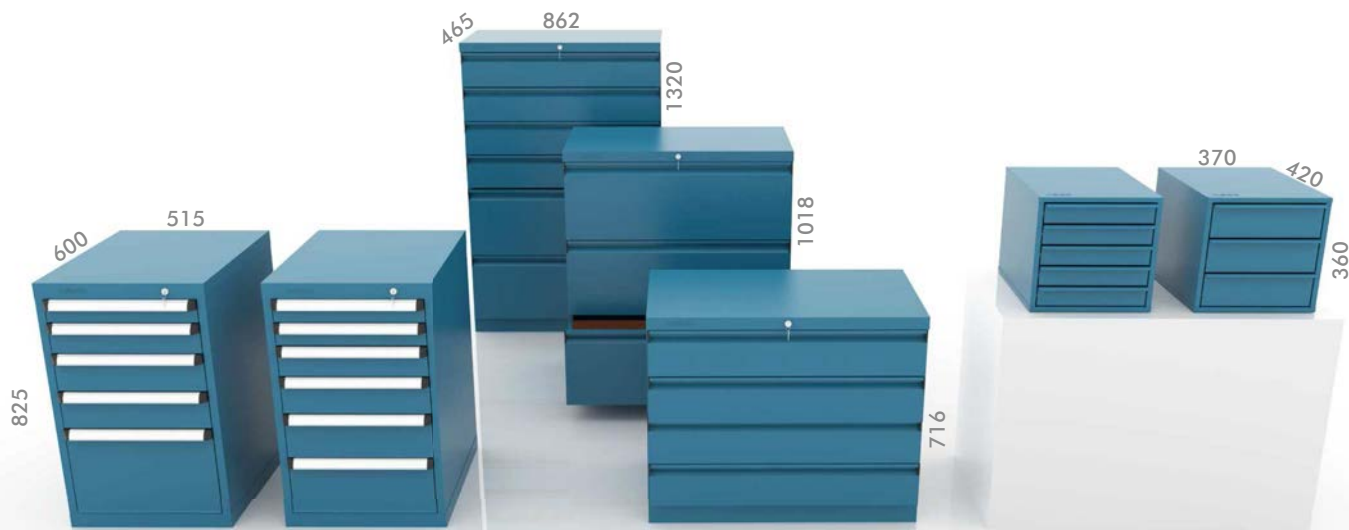

SERIE 136 2

SERIE 400

SERIE 106

INFORMACIÓN INFORMATION INFORMATION



Sistema antivuelco.
Système anti-renversement.
Anti-roll system.

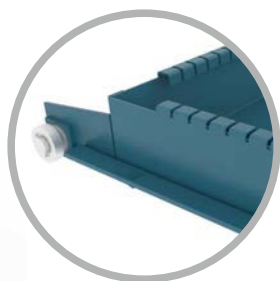

GS

Apertura 90%.
Ouverture 90%.
90% opening.

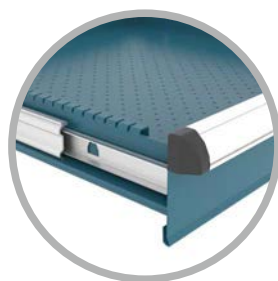

GT

Apertura 100%.
Ouverture 100%.
100% opening.

Guías simples o telescópicas.
Glissières simples ou télescopiques.
Simple or telescopic slides.

BE

Bandeja extraíble con GS o GT según cajones.
Plateau amovible avec GS ou GT selon les tiroirs.
Removable tray with GS or GT according to drawers.



Cierre centralizado.
Verrouillage centralisé.
Central locking.

ARMARIOS CON CAJONES ARMOIRES AVEC TIROIRS CABINETS WITH DRAWERS

- ES • Gran variedad de medidas y configuraciones.
- Diseño robusto y resistente.
- Cierre centralizado.
- Sistema antivuelco.
- Asas de aluminio con portaetiquetas.
- Cajones ranurados con separadores para la clasificación.
- Cierre electrónico. Sistema RFID opcional.
- Plazo de entrega 10 días laborables.
- Color estándar azul martelé posibilidad colores en opción.

- FR • Grande variété de tailles et configurations.
- Conception robuste et résistante.
- Verrouillage centralisé.
- Système anti-renversement.
- Poignées en aluminium avec porte-étiquettes.
- Tiroirs rainurés avec séparateurs pour la classification.
- Système RFID en option.
- Délai de livraison 10 jours ouvrables.
- Couleur standard bleu martelé possibilité teintes en option.

- EN • Wide range of sizes and configurations.
- Strong and resistant design.
- Central locking.
- Anti-roll system.
- Aluminum handles with label holders.
- Grooved drawers with dividers.
- Optional RFID system.
- Delivery time 10 working days.
- Standard colour hammered blue possibility optional colours.

SERIE 115

Cierre centralizado.
Verrouillage centralisé.
Central locking.



Accesorios opcionales
Accessoires optionnels
Optional accessories

Sistema antivuelco.
Système anti-renversement.
Anti-roll system.



Ref. **115 4**

Ref. **115 2**

Ref. **115 1**

Guías simples o telescópicas.
Glissières simples ou télescópiques.
Simple or telescopic slides.

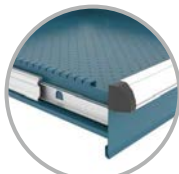

GS Apertura 90%.
Ouverture 90%.
90% opening.

GT Apertura 100%.
Ouverture 100%.
100% opening.

BE

Bandeja extraíble con GS o GT según cajones.
Plateau coulissant avec GS ou GT selon les tiroirs.
Removable tray with GS or GT according to drawers.

Ref. 115 4

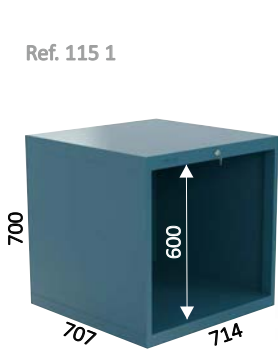

Ref. 115 1

KG 42 Kg
mm 750 x 750 x 900 mm

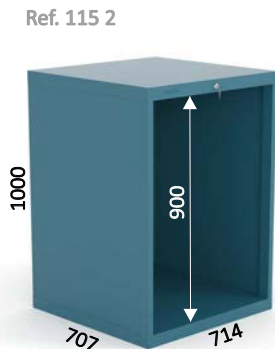

Ref. 115 2

KG 49 Kg
mm 750 x 750 x 1200 mm

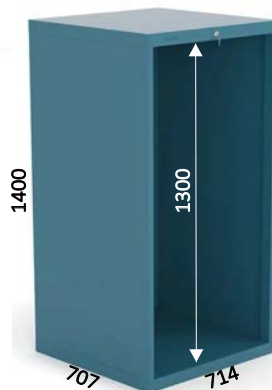

KG 56 Kg
mm 750 x 750 x 1600 mm

Ref. 115 Z
KG 3,8 Kg

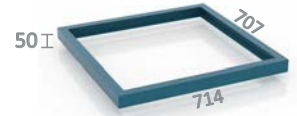

Ref. 115 S M
KG 18,7 Kg

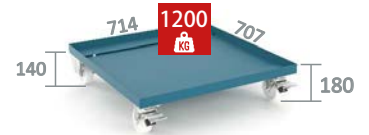

Ref. 115 S E
KG 7 Kg

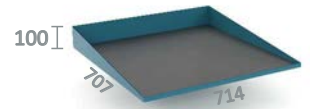

Ref. 115 B ISO 50
Ref. 115 B HSK 100
KG 22 Kg

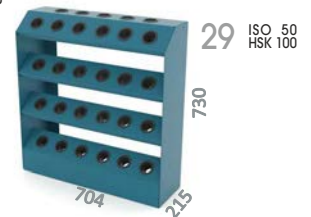

Ref. 115 B ISO 40
Ref. 115 B HSK 50
Ref. 115 B HSK 63
Ref. 115 B HSK 80
KG 22 Kg

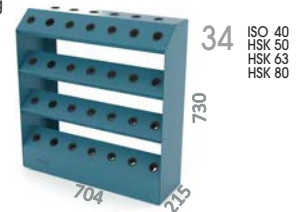

Ref. CE P 1



REF. CE P 1
REF. CE P 1 TM
REF. CE P 1 TU

KG Cierre electrónico
Verrou électronique
Electronic locking



Cajones / Tiroirs / Drawers

	GT 50	GS 100	GT 100	GT 200	GT 200 25 PORTACONOS 25 PORTE-CÔNES 25 TOOL HOLDER
C=75	● 115 T50 C75 6Kg	● 115 S100 C75 9Kg	● 115 T100 C75 11Kg	● 115 T200 C75 15Kg	● 115 T200 ISO 40
C=100	● 115 T50 C100 7Kg	● 115 S100 C100 10,5Kg	● 115 T100 C100 12,5Kg	● 115 T200 C100 16Kg	● 115 T200 HSK 50
C=125	● 115 T50 C125 7,5Kg	● 115 S100 C125 11Kg	● 115 T100 C125 13Kg	● 115 T200 C125 17Kg	● 115 T200 HSK 60
C=150	● 115 T50 C150 8,5Kg	● 115 S100 C150 12,5Kg	● 115 T100 C150 13,5Kg	● 115 T200 C150 18Kg	● 115 T200 HSK 80
C=200	● 115 T50 C200 9,5Kg	● 115 S100 C200 13Kg	● 115 T100 C200 14,5Kg	● 115 T200 C200 19,5Kg	● 115 T200 ISO 50
C=250	● 115 T50 C250 10,5Kg	● 115 S100 C250 14Kg	● 115 T100 C250 15,5Kg	● 115 T200 C250 20,5Kg	● 115 T200 HSK 100 28Kg
C=300					
	e 1 mm	e 1.5 mm	e 1.5 mm	e 1.5 mm	e 1.5 mm

Ref. 115 1

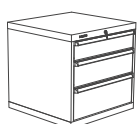

C150 **115 1 01** 71 Kg
 C200 **115 1 11** 82 Kg
 C250 **115 1 21** 85,5 Kg
115 1 31 100 Kg

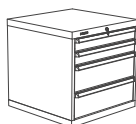

C100 **115 1 02** 77 Kg
 C100 **115 1 12** 89 Kg
 C200 **115 1 22** 96 Kg
115 1 32 113 Kg



C150 **115 1 03** 76 Kg
 C150 **115 1 13** 92 Kg
 C150 **115 1 23** 96 Kg
115 1 33 114 Kg



C75 **115 1 04** 74 Kg
 C75 **115 1 14** 87 Kg
 C250 **115 1 34** 112 Kg



C100 **115 1 05** 75 Kg
 C100 **115 1 15** 90 Kg
 C250 **115 1 35** 113 Kg

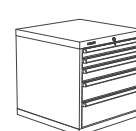

C75 **115 1 06** 80 Kg
 C75 **115 1 16** 96 Kg
 C150 **115 1 26** 104,5 Kg
 C200 **115 1 36** 126 Kg

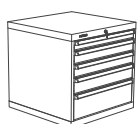

C75 **115 1 07** 79 Kg
 C100 **115 1 17** 96 Kg
 C125 **115 1 27** 105,5 Kg
 C200 **115 1 37** 126 Kg

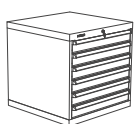

C100 **115 1 08** 84 Kg
 C100 **115 1 18** 105 Kg
 C100 **115 1 28** 117 Kg
 C100 **115 1 38** 138 Kg

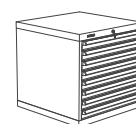

C75 **115 1 09** 90 Kg
 C75 **115 1 19** 114 Kg
 C75 **115 1 29** 130 Kg
 C75 **115 1 39** 162 Kg

Ref. 115 2



C75 **115 2 01** 94 Kg
 C100 **115 2 11** 112 Kg
 C150 **115 2 21** 128,5 Kg
 C200 **115 2 31** 143 Kg



C150 **115 2 02** 98 Kg
 C150 **115 2 12** 119 Kg
 C150 **115 2 22** 130 Kg
 C250 **115 2 32** 155 Kg



C75 **115 2 03** 100 Kg
 C75 **115 2 13** 124 Kg
 C100 **115 2 23** 137,5 Kg
 C250 **115 2 33** 172 Kg



C75 **115 2 04** 102 Kg
 C75 **115 2 14** 125 Kg
 C200 **115 2 34** 167 Kg



C75 **115 2 05** 107 Kg
 C100 **115 2 15** 135 Kg
 C125 **115 2 35** 181 Kg

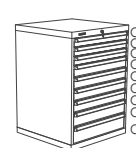

C75 **115 2 06** 80 Kg
 C75 **115 2 16** 142 Kg
 C100 **115 2 26** 158,5 Kg
 C150 **115 2 36** 193 Kg

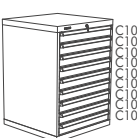

C100 **115 2 07** 112 Kg
 C100 **115 2 17** 144 Kg
 C100 **115 2 27** 161,5 Kg
 C100 **115 2 37** 193 Kg



C75 **115 2 08** 118 Kg
 C75 **115 2 18** 153 Kg
 C100 **115 2 38** 217 Kg

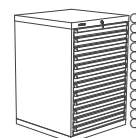

C75 **115 2 09** 121 Kg
 C75 **115 2 19** 157 Kg
 C75 **115 2 29** 181 Kg
 C75 **115 2 39** 229 Kg

Ref. 115 4



C100 **115 4 01** 120 Kg
 C100 **115 4 11** 145 Kg
 C100 **115 4 21** 160 Kg
 C200 **115 4 31** 189 Kg



C75 **115 4 02** 121 Kg
 C100 **115 4 12** 146 Kg
 C125 **115 4 22** 165 Kg
 C200 **115 4 32** 186 Kg



C100 **115 4 03** 124 Kg
 C100 **115 4 13** 152 Kg
 C250 **115 4 33** 201 Kg



C75 **115 4 04** 102 Kg
 C75 **115 4 14** 145 Kg
 C100 **115 4 24** 185 Kg
 C250 **115 4 34** 200 Kg

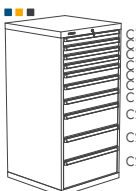

C75 **115 4 05** 132 Kg
 C75 **115 4 15** 165 Kg
 C200 **115 4 35** 226 Kg

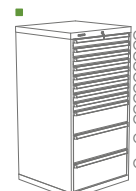

C75 **115 4 06** 134 Kg
 C75 **115 4 16** 167 Kg
 C125 **115 4 26** 189,5 Kg
 C250 **115 4 36** 226 Kg

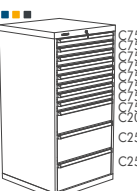

C75 **115 4 07** 135 Kg
 C75 **115 4 17** 169 Kg
 C250 **115 4 37** 237 Kg



C75 **115 4 08** 140 Kg
 C125 **115 4 18** 179 Kg
 C125 **115 4 28** 195 Kg
 C250 **115 4 38** 251 Kg

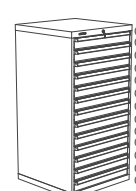

C100 **115 4 09** 147 Kg
 C100 **115 4 19** 193 Kg
 C100 **115 4 29** 218,5 Kg
 C100 **115 4 39** 264 Kg

SERIE 119

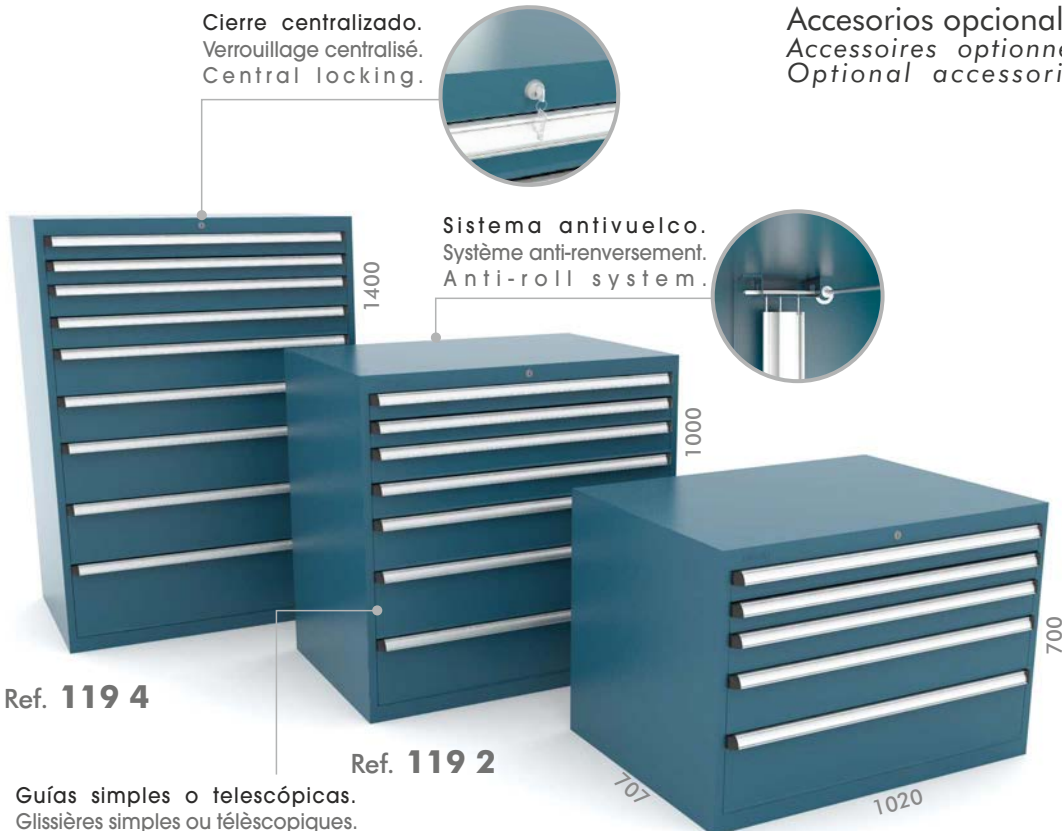

Accesorios opcionales
Accessoires optionnels
Optional accessories

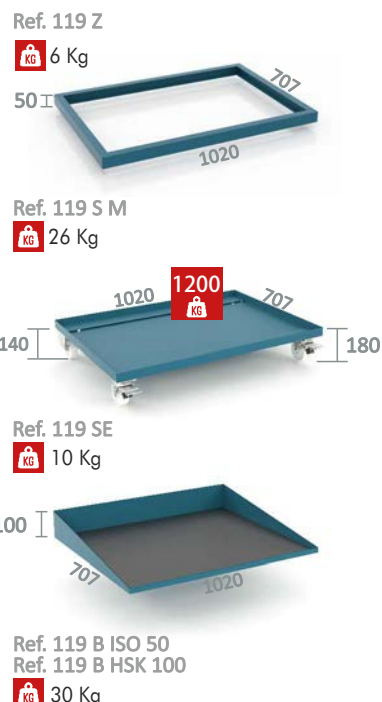

Guías simples o telescópicas.
Glissières simples ou télescópiques.
Simple or telescopic slides.

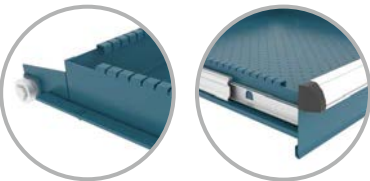

GS Apertura 90%.
Ouverture 90%.
90% opening.

GT Apertura 100%.
Ouverture 100%.
100% opening.

BE Bandeja extraíble con GS o GT según cajones.
Plateau coulissant avec GS ou GT selon les tiroirs.
Removable tray with GS or GT according to drawers.

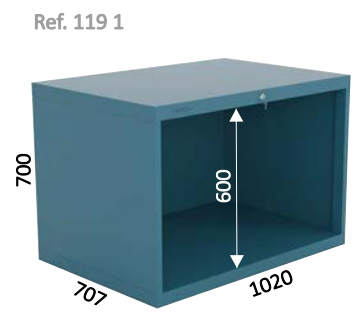
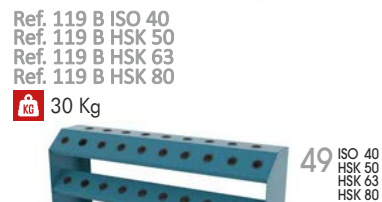
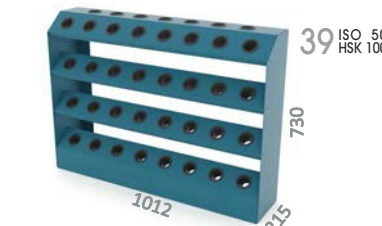

KG 54 Kg
1100 x 750 x 900 mm

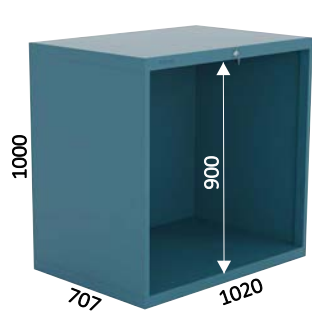

KG 62 Kg
1100 x 750 x 1200 mm

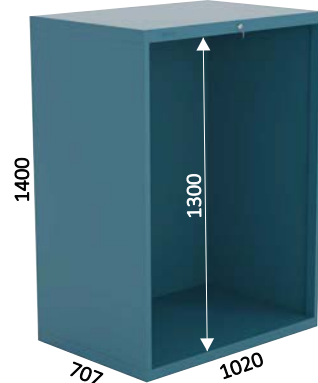

KG 70 Kg
1100 x 750 x 1600 mm



REF. CE P 1
Verrou électronique
Électronique locking

Cajones / Tiroirs / Drawers

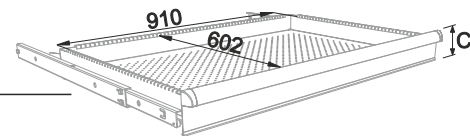

	GS 100 KG	GT 100 KG	GT 200 KG	GT 200 KG	35 PORTACONOS 35 PORTE-CÔNES 35 TOOL HOLDER
C=75	● 119 S100 C75 13Kg	● 119 T100 C75 16,5Kg	● 119 T200 C75 21,5Kg		119 T200 ISO 40 119 T200 HSK 50 119 T200 HSK 63 119 T200 HSK 80 119 T200 ISO 50 119 T200 HSK 100
C=100	● 119 S100 C100 15Kg	● 119 T100 C100 17,5Kg	● 119 T200 C100 22,5Kg		
C=125	● 119 S100 C125 15,5Kg	● 119 T100 C125 18,5Kg	● 119 T200 C125 23,5Kg		
C=150	● 119 S100 C150 16Kg	● 119 T100 C150 19Kg	● 119 T200 C150 24,5Kg		
C=200	● 119 S100 C200 18Kg	● 119 T100 C200 20Kg	● 119 T200 C200 25,5Kg		
C=250	● 119 S100 C250 19,5Kg	● 119 T100 C250 22,5Kg	● 119 T200 C250 27Kg		
C=300				●	
	e 1.5 mm	e 1.5 mm	e 1.5 mm	e 1.5 mm	33Kg 31Kg

Ref. 119 1

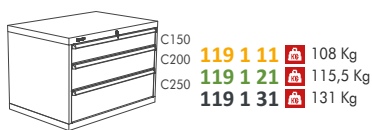

119 1 11 108 Kg
119 1 21 115,5 Kg
119 1 31 131 Kg

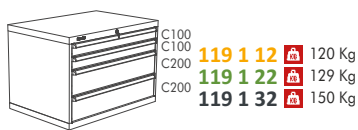

119 1 12 120 Kg
119 1 22 129 Kg
119 1 32 150 Kg



119 1 13 118 Kg
119 1 23 130 Kg
119 1 33 152 Kg

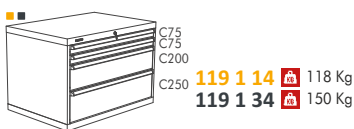

119 1 14 118 Kg
119 1 34 150 Kg

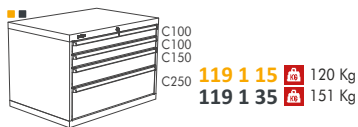

119 1 15 120 Kg
119 1 35 151 Kg

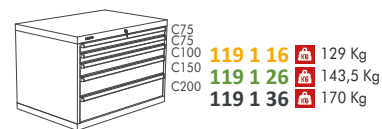

119 1 16 129 Kg
119 1 26 143,5 Kg
119 1 36 170 Kg

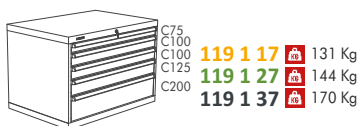

119 1 17 131 Kg
119 1 27 144 Kg
119 1 37 170 Kg

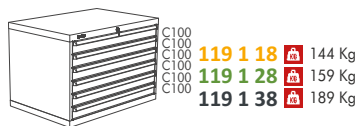

119 1 18 144 Kg
119 1 28 159 Kg
119 1 38 189 Kg

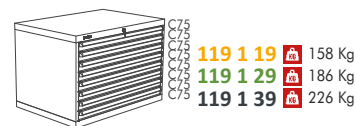

119 1 19 158 Kg
119 1 29 186 Kg
119 1 39 226 Kg

Ref. 119 2

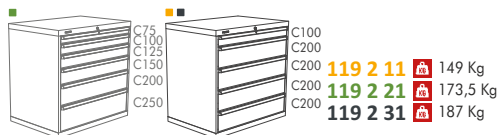

119 2 11 149 Kg
119 2 21 173,5 Kg
119 2 31 187 Kg

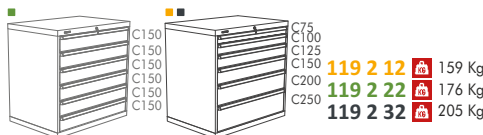

119 2 12 159 Kg
119 2 22 176 Kg
119 2 32 205 Kg



119 2 13 158 Kg
119 2 23 190 Kg
119 2 33 209 Kg



119 2 14 168 Kg
119 2 34 225 Kg

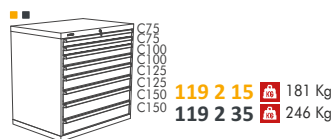

119 2 15 181 Kg
119 2 35 246 Kg

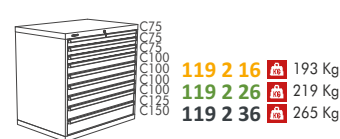

119 2 16 193 Kg
119 2 26 219 Kg
119 2 36 265 Kg

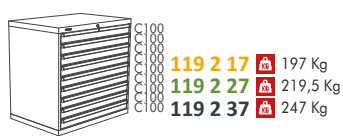

119 2 17 197 Kg
119 2 27 219,5 Kg
119 2 37 247 Kg

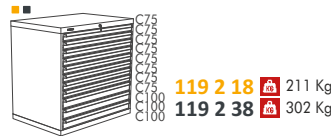

119 2 18 211 Kg
119 2 38 302 Kg

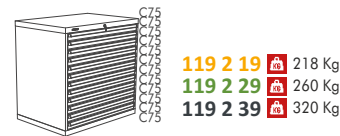

119 2 19 218 Kg
119 2 29 260 Kg
119 2 39 320 Kg

Ref. 119 4

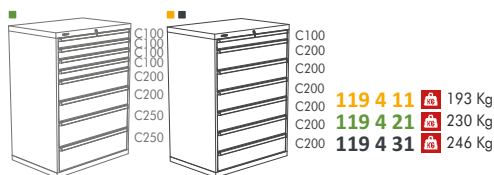

119 4 11 193 Kg
119 4 21 230 Kg
119 4 31 246 Kg

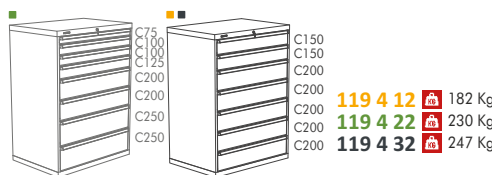

119 4 12 182 Kg
119 4 22 230 Kg
119 4 32 247 Kg

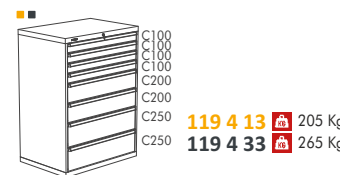

119 4 13 205 Kg
119 4 33 265 Kg

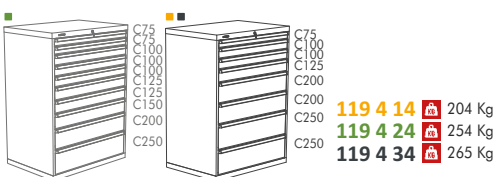

119 4 14 204 Kg
119 4 24 254 Kg
119 4 34 265 Kg

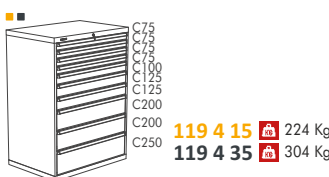

119 4 15 224 Kg
119 4 35 304 Kg

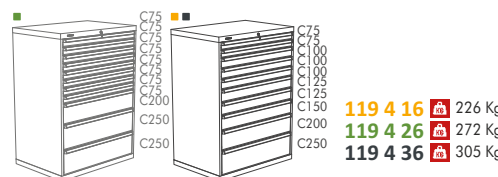

119 4 16 226 Kg
119 4 26 272 Kg
119 4 36 305 Kg

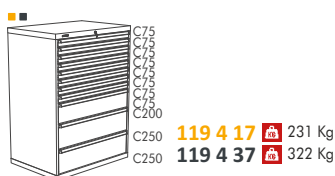

119 4 17 231 Kg
119 4 37 322 Kg

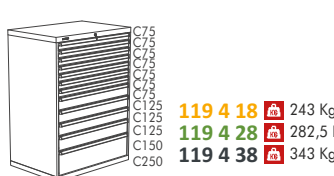

119 4 18 243 Kg
119 4 28 282,5 Kg
119 4 38 343 Kg

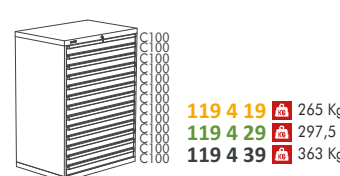

119 4 19 265 Kg
119 4 29 297,5 Kg
119 4 39 363 Kg

SERIE 143

Accesorios opcionales
Accessoires optionnels
Optional accessories

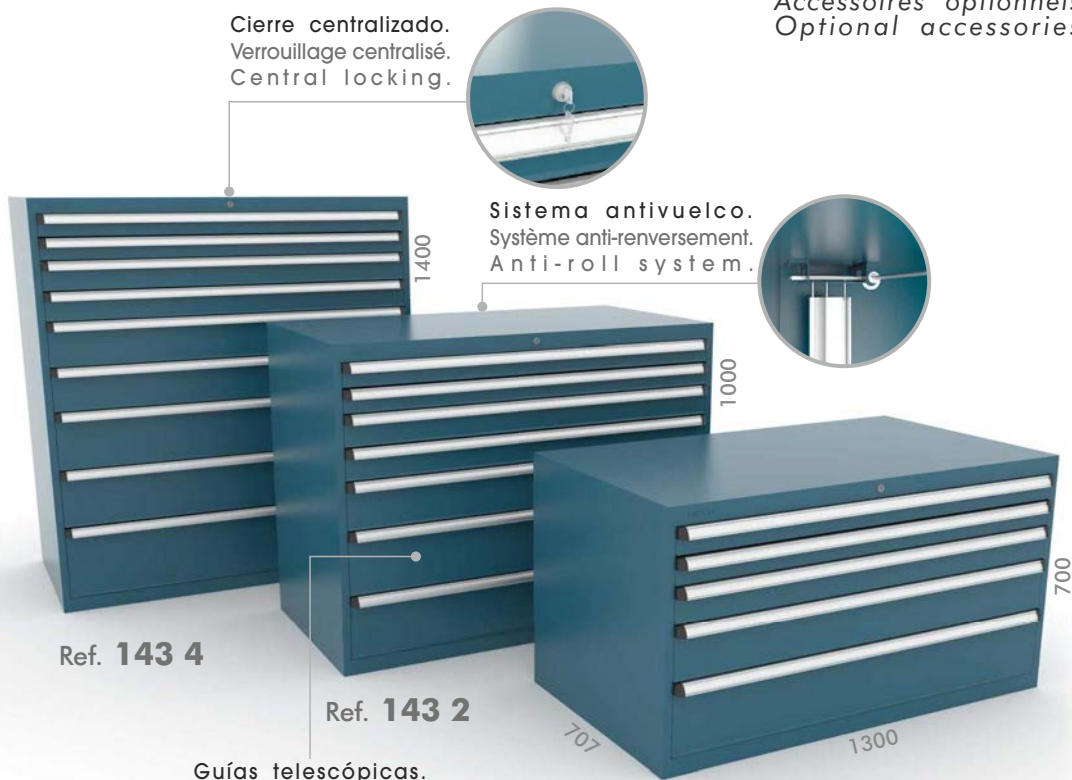

Ref. 143 4

Ref. 143 2

Ref. 143 1

Guías telescópicas.
Glissières télescópiques.
Telescopic slides.

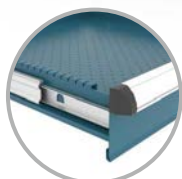

GT Apertura 100%.
Ouverture 100%.
100% opening.

BE Bandeja extraíble con GT.
Plateau coulissant avec GT.
Sliding shelf with GT.

Ref. 143 4

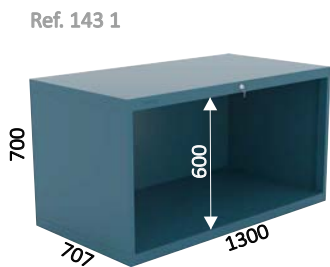

Ref. 143 1

KG 68,8 Kg
KG 1350 x 750 x 900 mm

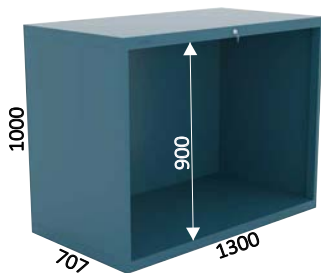

Ref. 143 2

KG 79 Kg
KG 1350 x 750 x 1200 mm

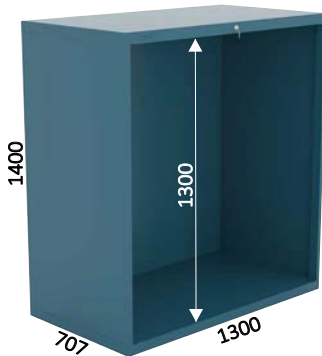

KG 87,2 Kg
KG 1350 x 750 x 1600 mm

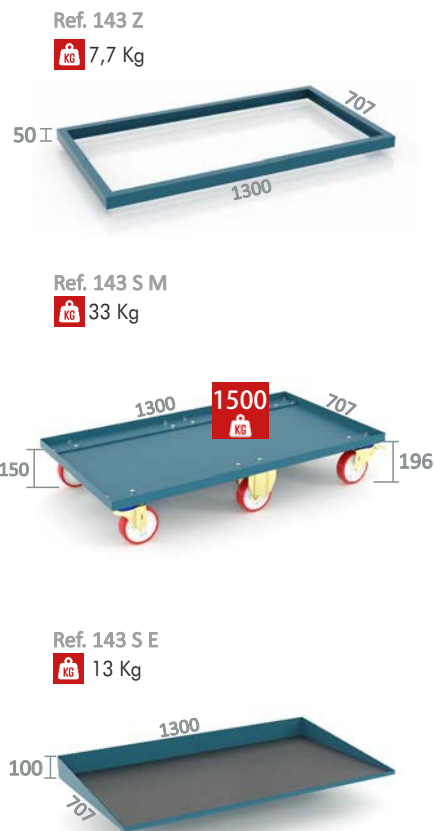

Ref. 143 Z
KG 7,7 Kg

Ref. 143 S M
KG 33 Kg

Ref. 143 S E
KG 13 Kg

Ref. CE P 1



REF. CE P 1
REF. CE P 1 TM
REF. CE P 1 TU

KG Cierre electrónico
Verrou électronique
Electronic locking

Cajones / Tiroirs / Drawers

		GT	200	
SERIE 143	C=75	●	143 T200 C75	27,4Kg
	C=100	●	143 T200 C100	28,7Kg
	C=125	●	143 T200 C125	30Kg
	C=150	●	143 T200 C150	31,2Kg
	C=200	●	143 T200 C200	32,5Kg
	C=250	●	143 T200 C250	34,4Kg
		e	1.5 mm	

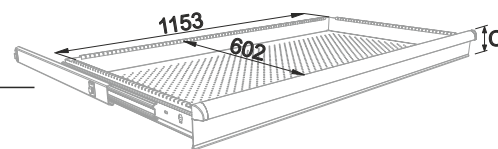

i Los cajones no incluyen divisiones.
Les tiroirs n'incluent pas les séparations.
Divisions for drawers no included.

i Las divisiones se sirven en acero galvanizado.
Les séparations sont fournies en acier galvanisé.
The divisions are supplied in galvanised steel.

SERIE 122



Accesorios opcionales
Accessoires optionnels
Optional accessories

Ref. 122 Z
3,2 Kg

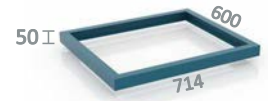

Ref. 122 S M
18 Kg

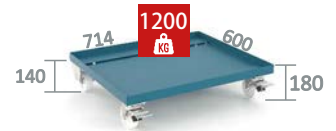

Ref. 122 SE
5,9 Kg

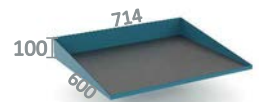

Ref. 115 B ISO 50
Ref. 115 B HSK 100
22 Kg

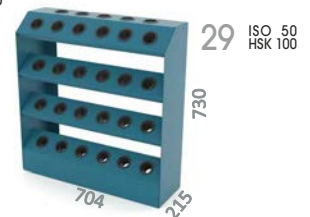

Ref. 115 B ISO 40
Ref. 115 B HSK 50
Ref. 115 B HSK 63
Ref. 115 B HSK 80
22 Kg

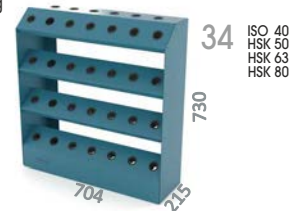

BE Bandeja extraíble con GS.
Plateau coulissant avec GS.
Sliding shelf with GS.

Ref. 122 4

GS Apertura 90%.
Ouverture 90%.
90% opening.

Ref. 122 2

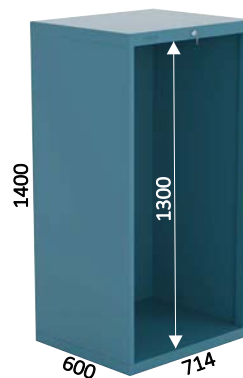

40 Kg
750 x 650 x 1600 mm

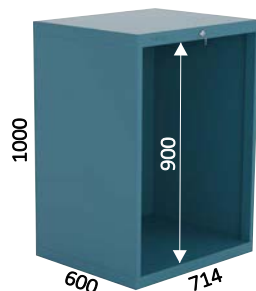

31 Kg
750 x 650 x 1200 mm

Ref. 122 1

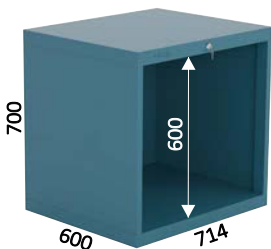

24.5 Kg
750 x 650 x 900 mm

Ref. CE P 1



REF. CE P 1
REF. CE P 1 TM
REF. CE P 1 TU

Cierre electrónico
Verrou électronique
Electronic locking

Cajones / Tiroirs / Drawers

		GS	100	
SERIE 122	C=75	●	122 S100 C75	7,5Kg
	C=100	●	122 S100 C100	8Kg
	C=125	●	122 S100 C125	8,5Kg
	C=150	●	122 S100 C150	9Kg
	C=200	●	122 S100 C200	10Kg
C=250	●	122 S100 C250	11Kg	
		e	1.2 mm	

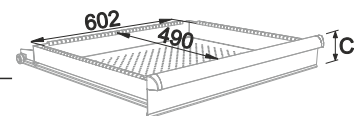

i Los cajones no incluyen divisiones.
Les tiroirs n'incluent pas les séparations.
Divisions for drawers no included.

i Las divisiones se sirven en acero galvanizado.
Les séparations sont fournies en acier galvanisé.
The divisions are supplied in galvanised steel.

Ref. **122 1**

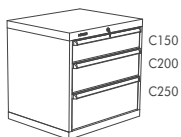

C150
C200
C250

122 1 11 54,5 Kg



C100
C100
C200
C200

122 1 12 60,5 Kg



C150
C150
C150
C150

122 1 13 60,5 Kg

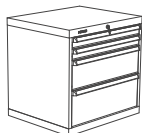

C75
C75
C200
C250

122 1 14 60,5 Kg



C100
C100
C150
C250

122 1 15 60,5 Kg



C75
C75
C100
C150
C200

122 1 16 66,5 Kg



C75
C100
C125
C200

122 1 17 66,5 Kg

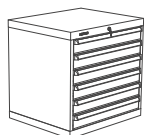

C100
C100
C100
C100
C100
C100

122 1 18 72,5 Kg

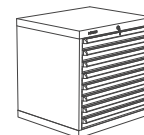

C75
C75
C75
C75
C75
C75
C75

122 1 19 84,5 Kg

Ref. **122 2**



C100
C200
C200
C200
C200

122 2 11 84,5 Kg



C75
C100
C125
C150
C200
C250

122 2 12 91 Kg



C150
C150
C150
C150
C150

122 2 13 91 Kg



C75
C75
C75
C100
C125
C200
C250

122 2 14 97 Kg



C75
C75
C100
C100
C125
C150
C150

122 2 15 103 Kg



C75
C75
C75
C100
C100
C100
C125
C150

122 2 16 103 Kg



C100
C100
C100
C100
C100
C100
C100
C100
C100

122 2 17 109 Kg



C75
C75
C75
C75
C75
C75
C75
C75
C100
C100

122 2 18 121 Kg

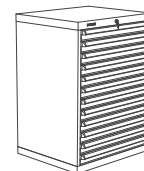

C75
C75
C75
C75
C75
C75
C75
C75
C75

122 2 19 127 Kg

Ref. **122 4**



C100
C200
C200
C200
C200
C200
C200

122 4 11 114 Kg



C150
C150
C200
C200
C200
C200
C200

122 4 12 114 Kg

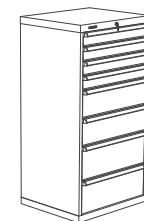

C100
C100
C100
C200
C200
C250
C250

122 4 13 120 Kg



C75
C100
C125
C200
C250
C250

122 4 14 121 Kg



C75
C75
C75
C100
C125
C125
C200
C200
C250

122 4 15 132,5 Kg

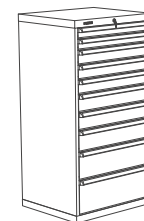

C75
C75
C100
C100
C125
C125
C150
C200
C250

122 4 16 126 Kg

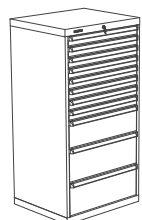

C75
C75
C75
C75
C75
C75
C200
C250
C250

122 4 17 138 Kg

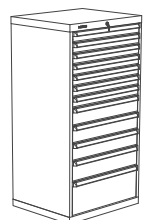

C75
C75
C75
C75
C75
C75
C125
C125
C150
C250

122 4 18 144 Kg

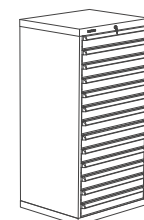

C100
C100
C100
C100
C100
C100
C100
C100
C100
C100

122 4 19 150 Kg

SERIE 123

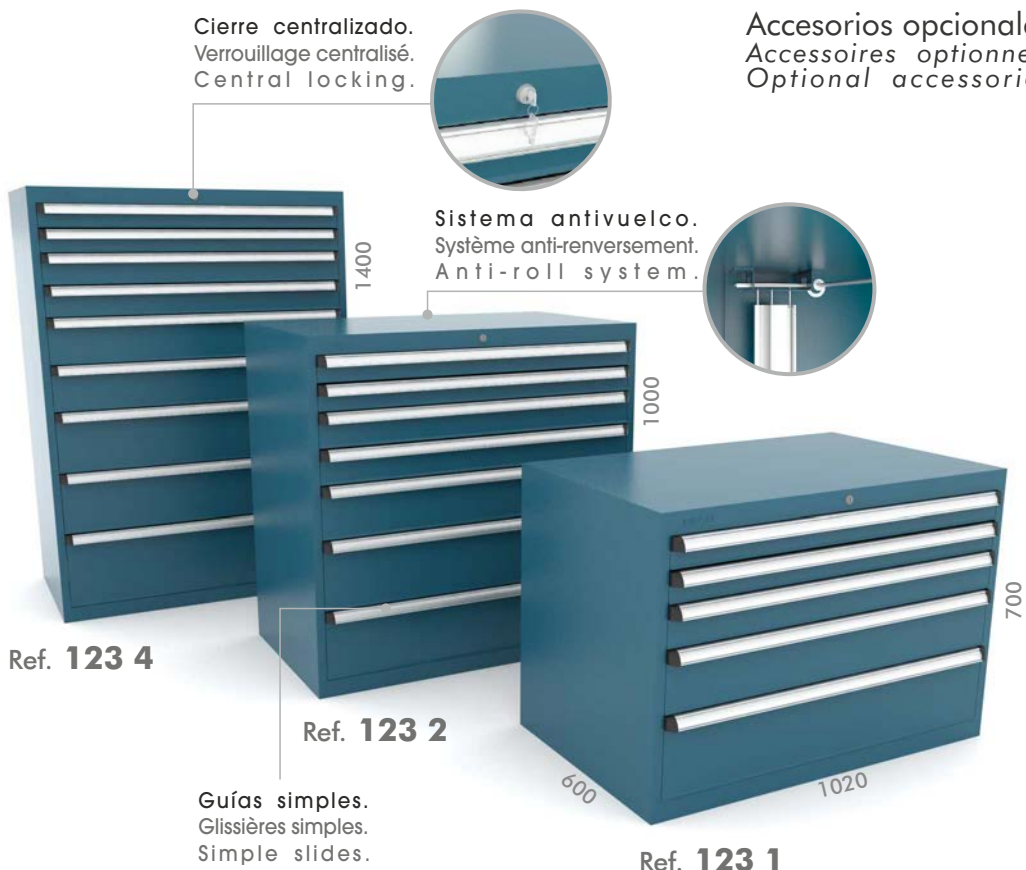

Accesorios opcionales
Accessoires optionnels
Optional accessories

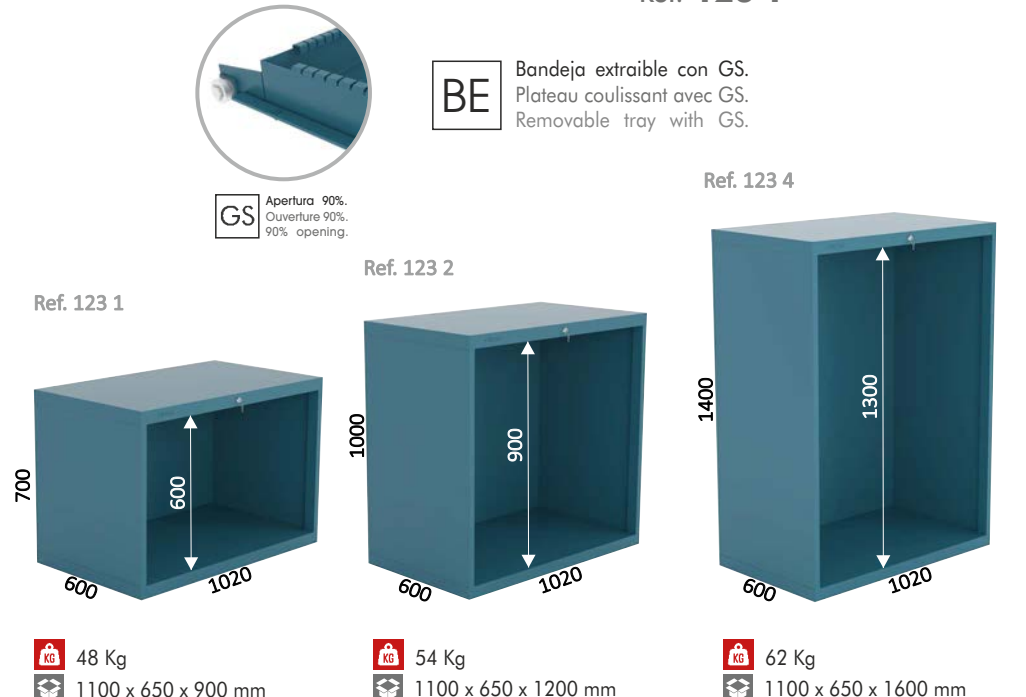
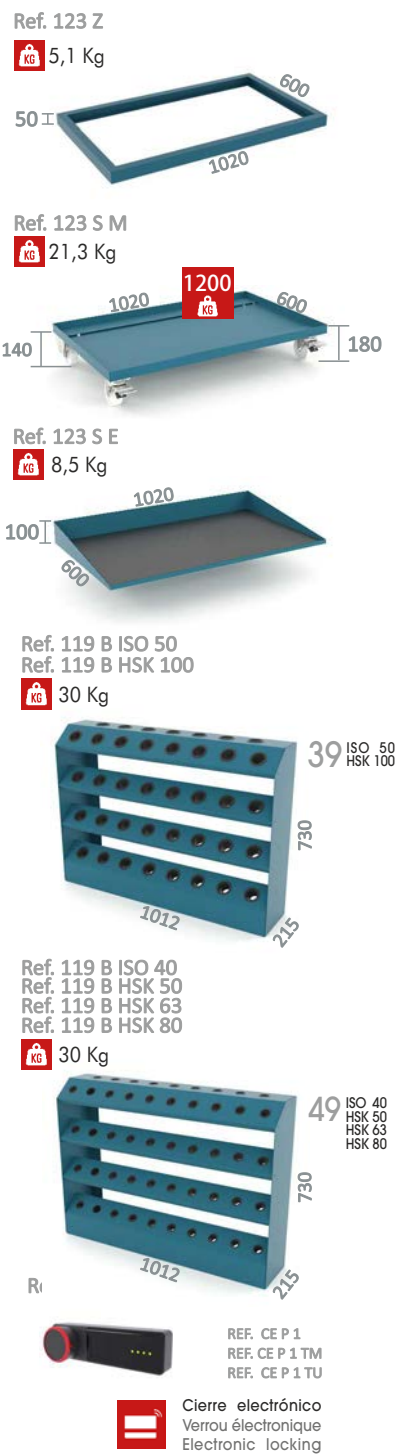

Cajones / Tiroirs / Drawers

SERIE 123	C=75	●	123 S100 C75	9,5Kg
●	123 S100 C125	11Kg		
●	123 S100 C150	11,5Kg		
●	123 S100 C200	13Kg		
●	123 S100 C250	14,5Kg		

e 1.2 mm

i Los cajones no incluyen divisiones.
Les tiroirs n'inclus pas les séparations.
Divisions for drawers no included.

i Las divisiones se sirven en acero galvanizado.
Les séparations sont fournies en acier galvanisé.
The divisions are supplied in galvanised steel.

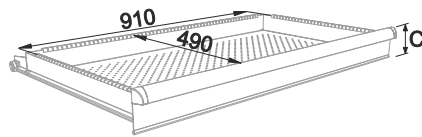

SERIE 135

Accesorios opcionales
Accessoires optionnels
Optional accessories

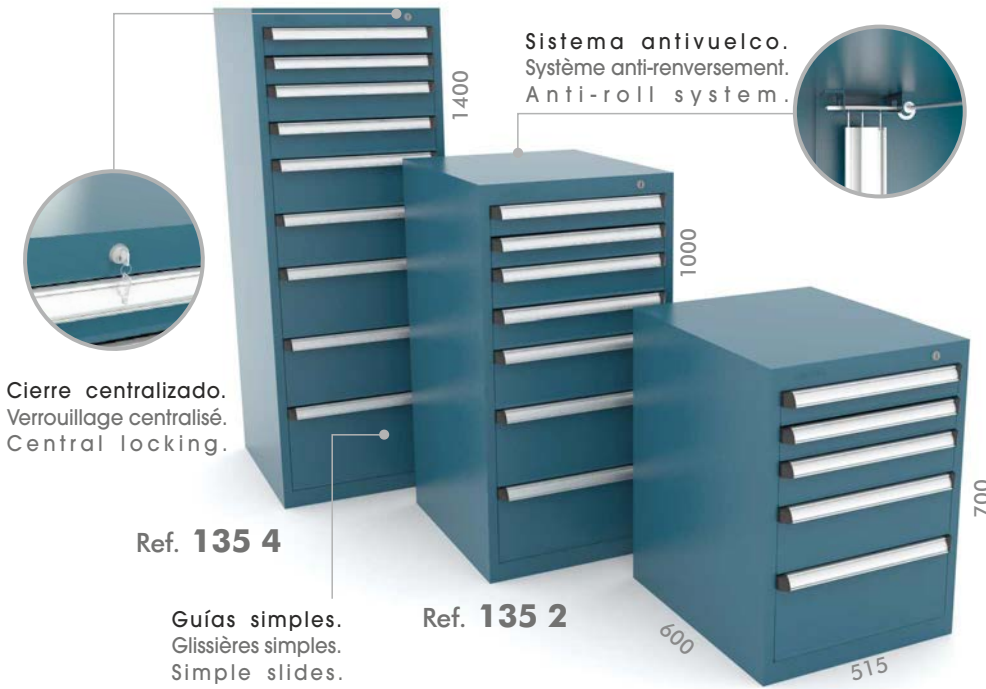

Ref. 135 4

Ref. 135 2

Ref. 135 1

Guías simples.
Glissières simples.
Simple slides.

BE Bandeja extraíble con GS.
Plateau coulissant avec GS.
Removable tray with GS.

GS Apertura 90%.
Ouverture 90%.
90% opening.

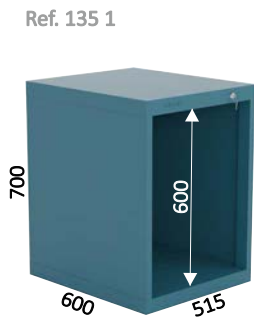

Ref. 135 1

KG 23 Kg
550 x 650 x 900 mm

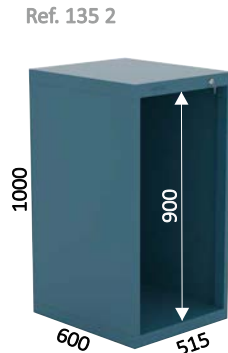

Ref. 135 2

KG 30 Kg
550 x 650 x 1200 mm

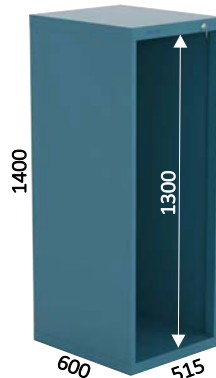

Ref. 135 4

KG 39.5 Kg
550 x 650 x 1600 mm

Ref. 135 Z
KG 3 Kg



Ref. 135 S M
KG 13 Kg



Ref. 135 SE
KG 5 Kg

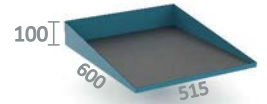

Ref. 135 B ISO 50
Ref. 135 B HSK 100
KG 17 Kg



Ref. 135 B ISO 40
Ref. 135 B HSK 50
Ref. 135 B HSK 63
Ref. 135 B HSK 80
KG 17 Kg



Ref. CE P 1



REF. CE P 1
REF. CE P 1 TM
REF. CE P 1 TU

KG Cierre electrónico
Verrou électronique
Electronic locking

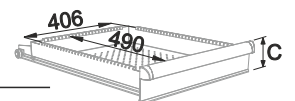

Cajones / Tiroirs / Drawers

SERIE 135	C=75	●	GS 100 KG		135 S100 C75	6,5Kg	12 PORTACONOS 12 PORTE-CÔNES 12 TOOL HOLDER
			GS 100 KG				
	C=100	●	GS 100 KG		135 S100 C100	7Kg	
	C=125	●	GS 100 KG		135 S100 C125	7,5Kg	
	C=150	●	GS 100 KG		135 S100 C150	8Kg	
	C=200	●	GS 100 KG		135 S100 C200	8,5Kg	
	C=250	●	GS 100 KG		135 S100 C250	9,5Kg	
	C=300	●	GS 100 KG		135 S100 C300	10,5Kg	
			e 1 mm				
			e 1 mm				

i Los cajones no incluyen divisiones.
Les tiroirs n'incluent pas les séparations.
Divisions for drawers no included.

i Las divisiones se sirven en acero galvanizado.
Les séparations sont fournies en acier galvanisé.
The divisions are supplied in galvanised steel.

Ref. **135 1**

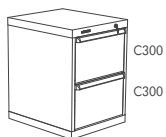

C300
C300

135 1 11 44 Kg



C75
C100
C125
C300

135 1 12 54,5 Kg



C150
C150
C150
C150

135 1 13 55 Kg

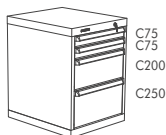

C75
C75
C200
C250

135 1 14 54 Kg



C100
C100
C150
C250

135 1 15 54,5 Kg



C75
C75
C100
C150
C200

135 1 16 59,5 Kg



C75
C100
C100
C125
C200

135 1 17 59,5 Kg



C100
C100
C100
C100
C100
C100

135 1 18 65 Kg

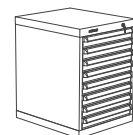

C75
C75
C75
C75
C75
C75

135 1 19 75 Kg

Ref. **135 2**



C100
C200
C200
C200
C200

135 2 11 71 Kg



C75
C100
C125
C150
C200
C250

135 2 12 77 Kg



C150
C150
C150
C150
C150

135 2 13 78 Kg



C75
C75
C75
C100
C125
C200
C250

135 2 14 82 Kg



C75
C75
C100
C100
C125
C125
C150
C150

135 2 15 88 Kg

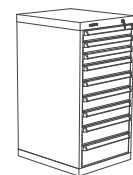

C75
C75
C100
C100
C100
C100
C125
C125
C150

135 2 16 93 Kg

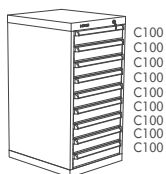

C100
C100
C100
C100
C100
C100
C100
C100
C100

135 2 17 93 Kg

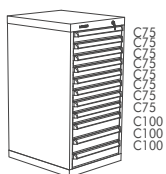

C75
C75
C75
C75
C75
C75
C75
C100
C100
C100

135 2 18 103 Kg

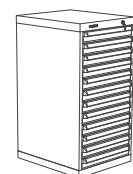

C75
C75
C75
C75
C75
C75
C75
C75
C75
C75

135 2 19 108 Kg

Ref. **135 4**

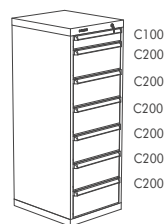

C100
C200
C200
C200
C200
C200
C200
C200

135 4 11 97,5 Kg

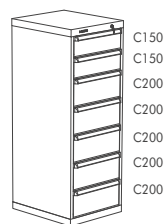

C150
C150
C200
C200
C200
C200
C200

135 4 12 98 Kg



C100
C100
C100
C100
C200
C200
C250
C250

135 4 13 103,5 Kg

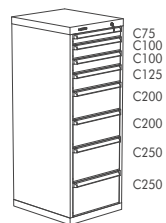

C75
C100
C100
C125
C200
C200
C250
C250

135 4 14 103,5 Kg

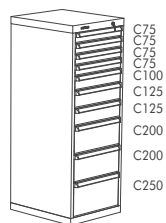

C75
C75
C75
C75
C100
C125
C125
C200
C200
C250

135 4 15 114 Kg

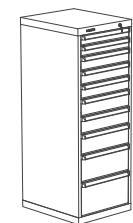

C75
C75
C100
C100
C100
C125
C125
C150
C200
C250

135 4 16 114,5 Kg

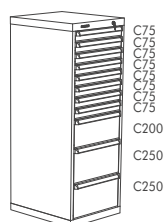

C75
C75
C75
C75
C75
C75
C75
C200
C250
C250

135 4 17 119 Kg

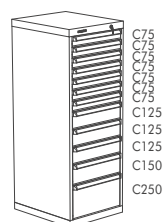

C75
C75
C75
C75
C75
C75
C75
C125
C125
C125
C150
C250

135 4 18 125 Kg

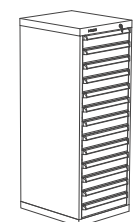

C100
C100
C100
C100
C100
C100
C100
C100
C100
C100
C100
C100

135 4 19 130,5 Kg

SERIE **136 2**



Cierre centralizado.
Verrouillage centralisé.
Central locking.



Sistema antivuelco.
Système anti-renversement.
Anti-roll system.



Guías simples.
Glissières simples.
Simple slides.

GS Apertura 90%.
Ouverture 90%.
90% opening.



Ref. **136 2 1**



Ref. **136 2 2**

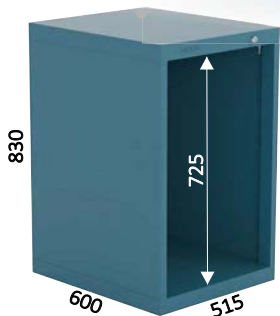

Gama de productos
Gamme de produits
Product range

SERIE 136 2

KG 25 Kg
KG 550 x 650 x 900 mm



Ref. **136 2 1**

KG 62 Kg



Ref. **136 2 2**

KG 67 Kg

- 135 S100 C75
- 135 S100 C100
- 135 S100 C125
- 135 S100 C125
- 135 S100 C300

- 135 S100 C75
- 135 S100 C75
- 135 S100 C100
- 135 S100 C125
- 135 S100 C150
- 135 S100 C200

Accesorios opcionales
Accessoires optionnels
Optional accessories

Ref. CE P 1



REF. CE P 1
REF. CE P 1 TM
REF. CE P 1 TU

KG Cierre electrónico
Verrou électronique
Electronic locking

Cajones / Tiroirs / Drawers

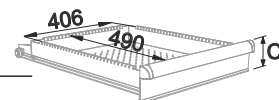

SERIE 136 2	GS 100 136 2 1		GS 100 136 2 2		GS 100 12 PORTACONOS 12 PORTE-CÔNES 12 TOOL HOLDER	
	C=50					
C=75	●	135 S100 C75 6,5Kg	● (x2)	135 S100 C75 6,5Kg		135 S100 ISO 40
C=100	●	135 S100 C100 7Kg	●	135 S100 C100 7Kg		135 S100 HSK 50
C=125	● (x2)	135 S100 C125 7,5Kg	●	135 S100 C125 7,5Kg		135 S100 HSK 63
C=150			●	135 S100 C150 8Kg		135 S100 HSK 80
C=200			●	135 S100 C200 8,5Kg		135 S100 ISO 50
C=250						135 S100 ISO 50
C=300	●	135 S100 C300 10,5Kg			●	135 S100 HSK 100 10,5Kg
	e	1 mm	e	1 mm	e	1 mm

i Los cajones no incluyen divisiones.
Les tiroirs n'inclus pas les séparations.
Divisions for drawers no included.

i Las divisiones se sirven en acero galvanizado.
Les séparations sont fournies en acier galvanisé.
The divisions are supplied in galvanised steel.

Armario con cajones de reducidas dimensiones (5 o 3 cajones).
 Armoire avec tiroirs de dimension réduites (5 ou 3 tiroirs).
 Cabinet with drawers of reduced dimension (5 or 3 drawers).

Ref. **106 4 1**

17,21 Kg

Ref. **106 4 2**

19,26 Kg

Ref. **106 4 3**

15,90 Kg



Ref. **106 4 4**

14,83 Kg

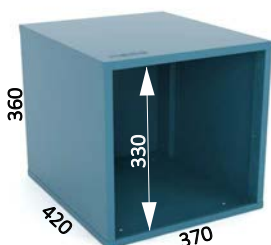

Ref. 106

6,39 Kg

400 x 450 x 400 mm

Cajones / Tiroirs / Drawers

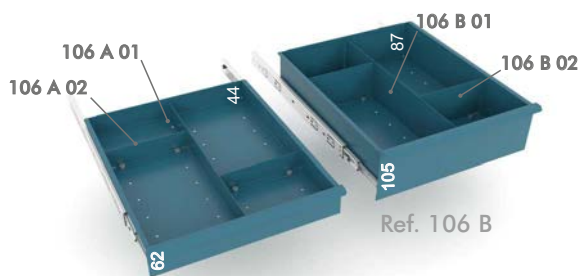

Ref. 106 A

Ref. 106 B

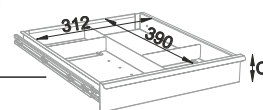

106 A	C=62	4,26 Kg
106 B	C=105	4,42 Kg

GT	15
●	(x5)
●	(x3)
	0.8 mm



Los divisiones se sirven en acero galvanizado.
 Les séparations sont fournies en acier galvanisé.
 The divisions are supplied in galvanised steel.

Gama de productos / Gamme de produits / Product range

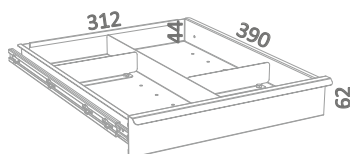
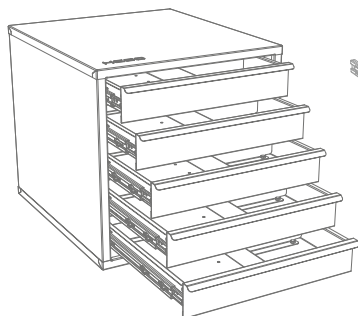

Ref. **106 4 1**

17,21 Kg

CAJONES
TIROIRS
DRAWERS
106 A x5
DIVISIONES
SÉPARATIONS
DIVISIONS
1u. 106 A 01
2u. 106 A 02

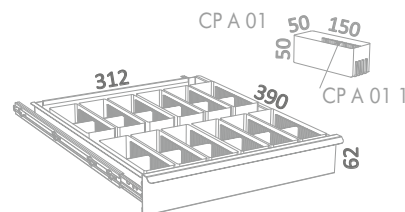
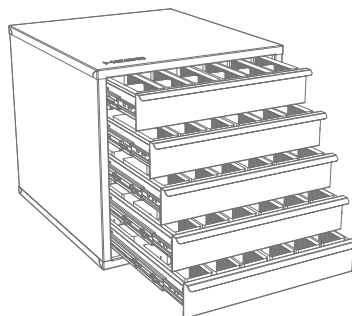

Ref. **106 4 2**

19,26 Kg

CAJONES
TIROIRS
DRAWERS
106 A x5
CUBETAS
BOITES
TRAYS
12u. CP A 01
12u. CP A 01 1

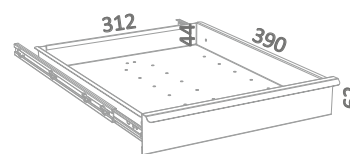
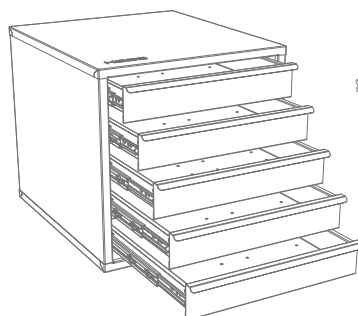

Ref. **106 4 3**

15,90 Kg

CAJONES
TIROIRS
DRAWERS
106 A x5

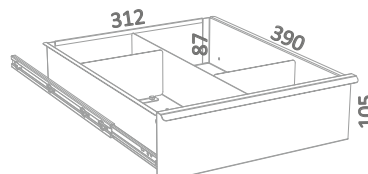
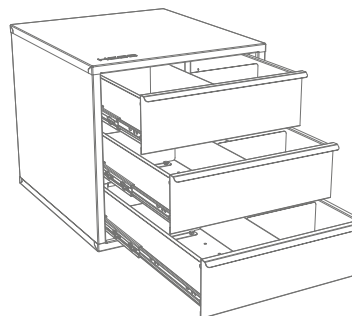

Ref. **106 4 4**

14,83 Kg

CAJONES
TIROIRS
DRAWERS
106 B x3
DIVISIONES
SÉPARATIONS
DIVISIONS
1u. 106 B 01
2u. 106 B 02

SERIE 400

oficinas
bureaux
offices

Armarios archivadores.
Armoire à classeurs.
Closets filing cabinets.

Ref. 4400



Ref. 4300



Ref. 4200

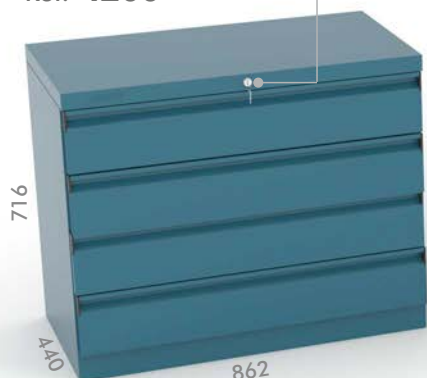

Cierre centralizado.
Verrouillage centralisé.
Central locking.

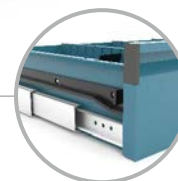
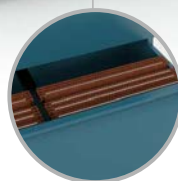

Consultar plazo de entrega.
Consulter le delai de livraison.
Check delivery time.

Soporte para archivadores. Incluidos en serie 400 F.
Support pour classeurs. Inclus dans série 400 F.
Folding - holder. Included at serie 400 F.

Bloqueo cajones y guías.
Verrouillage des tiroirs et glissières.
Locking drawers and slides.

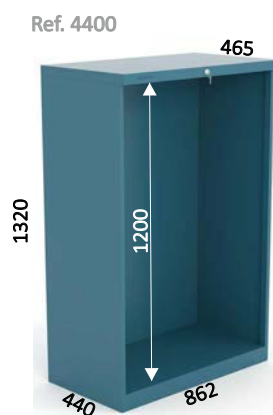
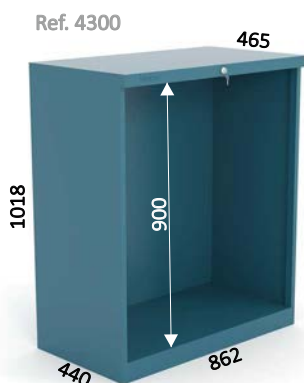
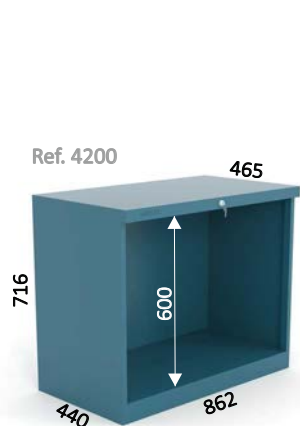

Accesorios opcionales
Accessoires optionnels
Optional accessories

Ref. CE P 1



REF. CE P 1
REF. CE P 1 TM
REF. CE P 1 TU



Cierre electrónico
Verrou électronique
Electronic locking

KG 13,5 Kg
KG 900 x 500 x 800 mm

KG 15,5 Kg
KG 900 x 500 x 1100 mm

KG 17,8 Kg
KG 900 x 500 x 1300 mm

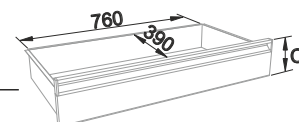

Cajones / Tiroirs / Drawers

			GT 50
400 C	C=150	6,4 Kg	●
400 F	C=300	11 Kg	●
		e 0.8 mm	



Los cajones no incluyen divisiones.
Les tiroirs n'incluent pas les séparations.
Divisions for drawers no included.



Los divisiones se sirven en acero galvanizado.
Les séparations sont fournies en acier galvanisé.
The divisions are supplied in galvanised steel.



Existen composiciones estándares de cajones, ver en catálogo web.
Des compositions de tiroirs standard sont disponibles, voir le catalogue en ligne.
Standard drawer compositions are available, see web catalogue.

Ref. **4200**

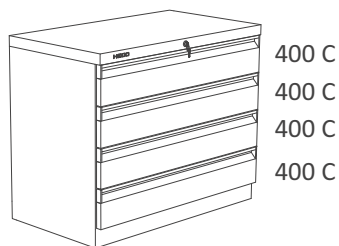

Ref. **4204**
 41,8 Kg
H 716 mm

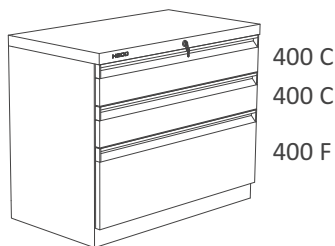

Ref. **4212**
 38,5Kg
H 716 mm

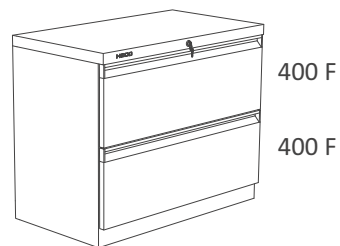

Ref. **4220**
 35,5 Kg
H 716 mm

Ref. **4300**

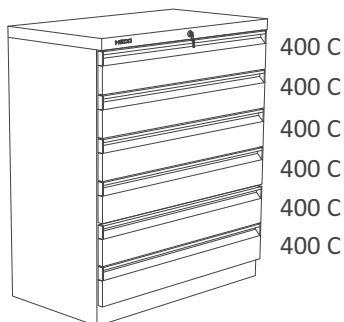

Ref. **4306**
 58,2 Kg
H 1018 mm

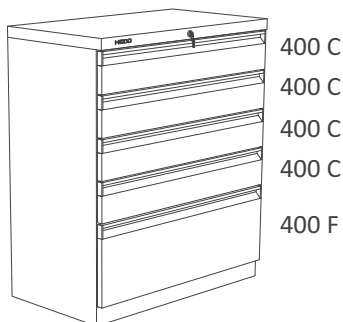

Ref. **4314**
 55 Kg
H 1018 mm

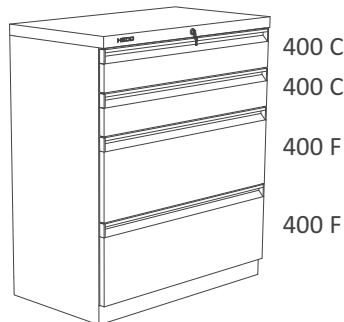

Ref. **4322**
 52 Kg
H 1018 mm

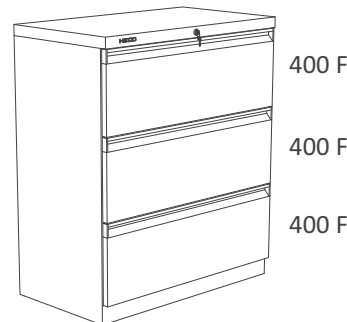

Ref. **4330**
 48,5 Kg
H 1018 mm

Ref. **4400**

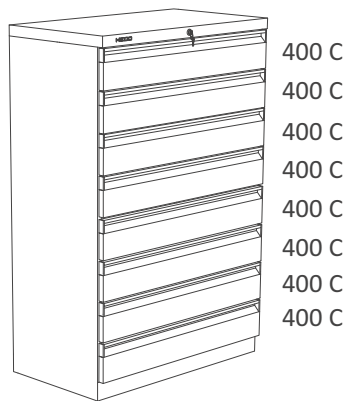

Ref. **4408**
 74,6 Kg
H 1320 mm

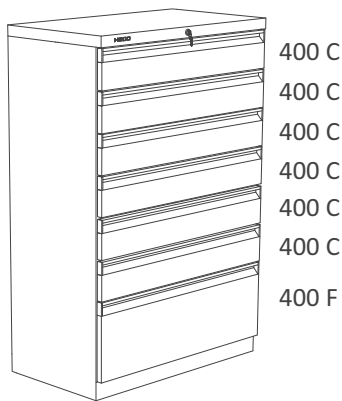

Ref. **4416**
 71,5 Kg
H 1320 mm



Ref. **4424**
 68,2 Kg
H 1320 mm

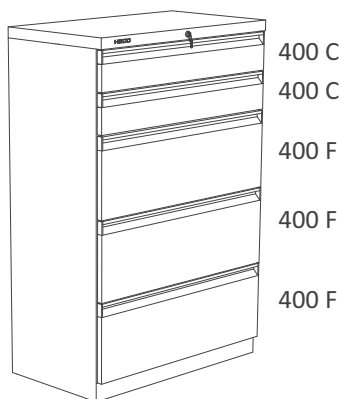

Ref. **4432**
 65 Kg
H 1320 mm

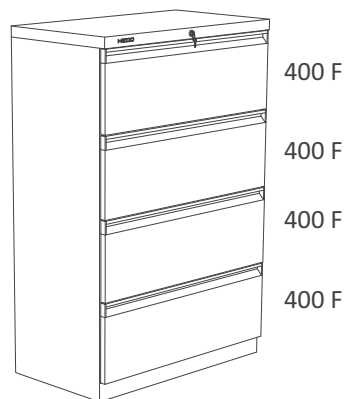

Ref. **4440**
 61,8 Kg
H 1320 mm

SERIE 400

Divisiones estandar para armarios de oficinas.
 Séparateurs standards pour armoires de bureaux.
 Standard divisions compositions for offices cabinets.

Ref. 400 43 C

400 C (Hf 150mm)

1x 400 RF C
 3x 400 C 208
 5x 400 RL C
 1x 400 RA C

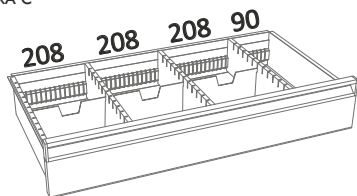

Ref. 400 44 C

400 C (Hf 150mm)

1x 400 RF C
 3x 400 C 222
 4x 400 RL C
 1x 400 RA C

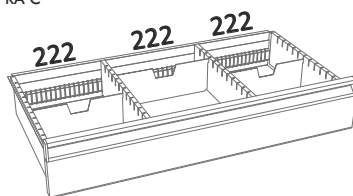

Ref. 400 45 C

400 C (Hf 150mm)

1x 400 RF C
 4x 400 C 152
 7x 400 RL C
 1x 400 RA C

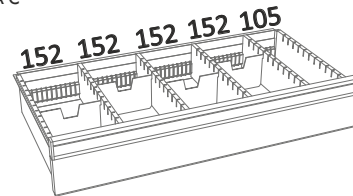

Ref. 400 33 F

400 F (Hf 300mm)

1x 400 RF F
 2x 400 F 363
 2x 400 RL F
 1x 400 RA F

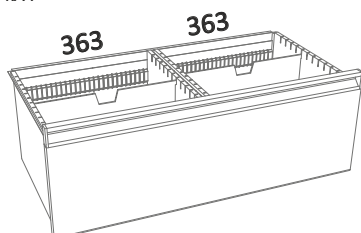

Ref. 400 35 F

400 F (Hf 300mm)

1x 400 RF F
 2x 400 F 306
 2x 400 RL F
 1x 400 RA F

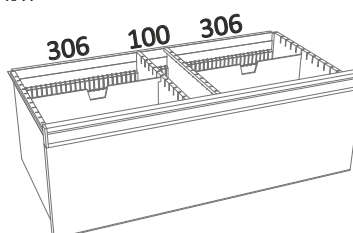

Ref. 400 40 F

400 F (Hf 300mm)

1x 400 RF F
 2x 400 F 152
 7x 400 RL F
 1x 400 RA F

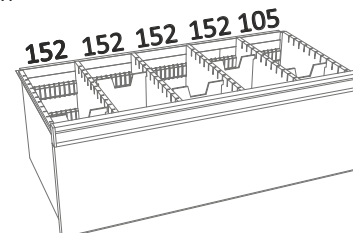

Accesorios para armarios de oficinas.
 Accessoires pour armoires de bureaux.
 Accessories for offices cabinets.

Longitudinales / Longitudinales / Longitudinals

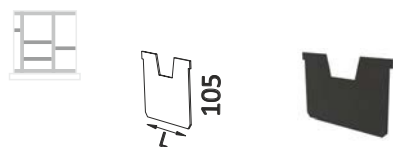

L 82 / 110 / 138 / 152 / 208 / 222

Ref. 400 C

 1.5 mm

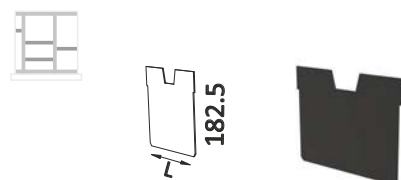

L 110 / 152 / 222 / 250 / 306 / 348 / 363

Ref. 400 F

 1.5 mm

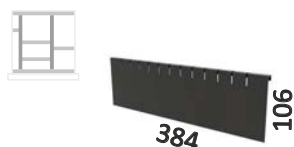

Ref. 400 RL C

 1 mm

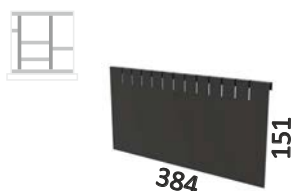

Ref. 400 RL F

 1 mm

Ranuradas / Rainures / Slotted

Ref. 400 RA/RF C

 1+0.6 mm

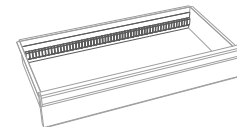
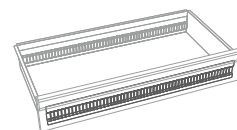

Ref. 400 RA/RF F

 1+0.6 mm

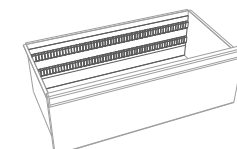
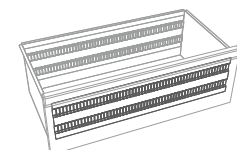
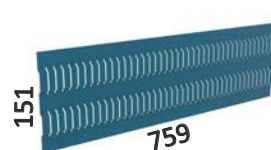

Es indispensable coger las divisiones RA y RF según cajón C o F.
 Il est essentiel de prendre les divisions RA et RF en fonction du tiroir C ou F.
 It is essential to take the RA and RF divisions according to drawer C or F.

SERIE CP A

CUBETAS EN PS.
BOITES EN PS.
PS TRAYS.



CLASIFICADORES
TRIEUSES
SORTERS

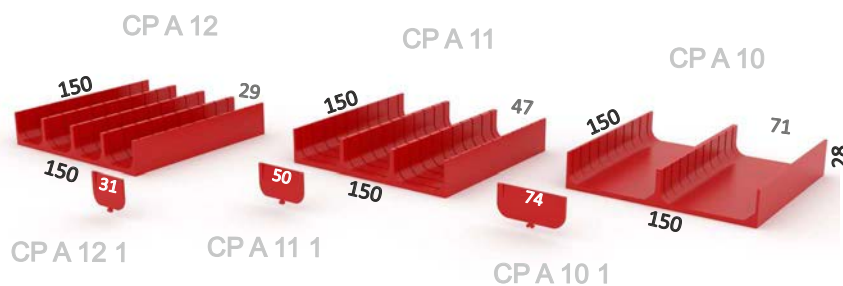

SERIE MP

CLASIFICADORES ABS
TRIEUSES ABS
ABS SORTERS

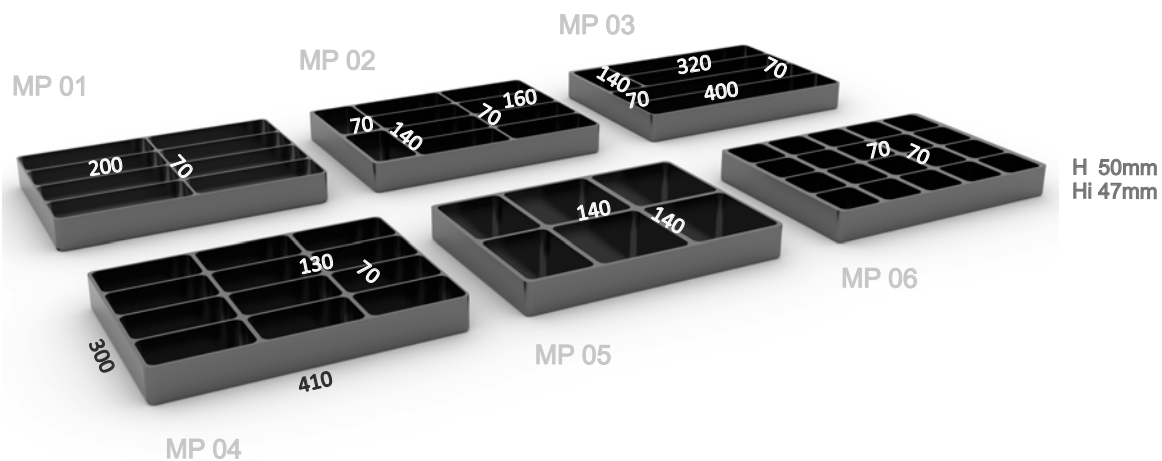

CONSULTAR DISPONIBILIDAD Hasta fin de existencias
VÉRIFIER LA DISPONIBILITÉ Jusqu'à épuisement du stock
CHECK AVAILABILITY Until end of stock

SERIE 115-126-127

Divisiones para cajones según altura frontal.
Séparateurs des tiroirs selon hauteur de frontal.
Drawer divisions according to front height.

Ref. **115 Hf D1**
HF 050-075-100-125-150-200-250

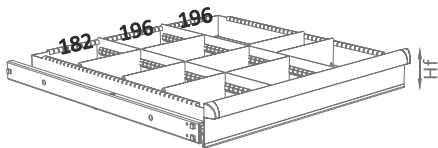

Ref. **115 Hf D2**
HF 050-075-100-125-150-200-250

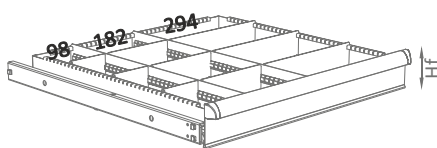

Ref. **115 Hf D3**
HF 050-075-100-125-150-200-250

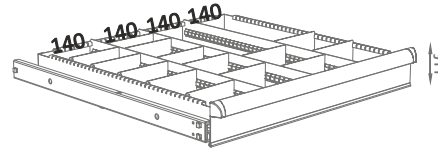

Ref. **115 Hf D4**
HF 050-075-100-125-150-200-250

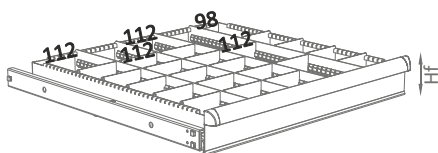

Ref. **115 Hf D5**
HF 050-075-100-125-150-200-250

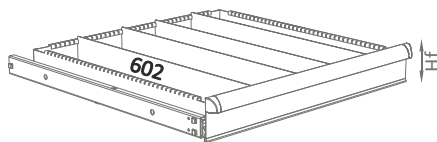

Ref. **115 Hf D6**
HF 050-075-100-125-150-200-250

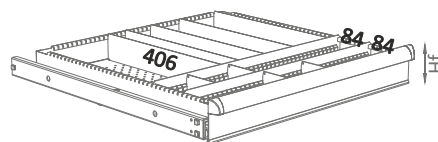

SERIE 115-126-127

Cubetas para cajones según altura frontal, sólo cajón 75 y 100.
Boîtes des tiroirs selon hauteur de frontal, tiroir 75 et 100 seulement.
Drawer trays according to front height, drawer 75 and 100 only.

Ref. **115 MP 01-02**
HF 075-100

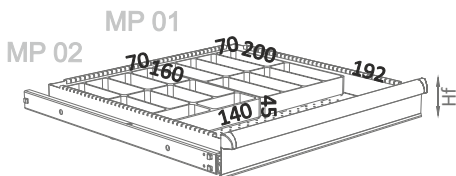

Ref. **115 MP 03-04**
HF 075-100

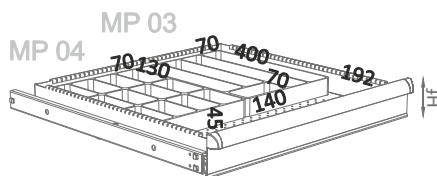

Ref. **115 MP 05-06**
HF 075-100

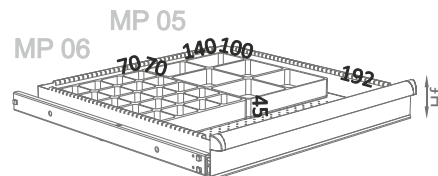

SERIE 115-126-127

Cubetas para cajones según altura frontal.
Boîtes des tiroirs selon hauteur de frontal.
Drawer trays according to front height.

Ref. **115 075 C1**
HF 075-100
48x CPA 01
48x CPA 01 1

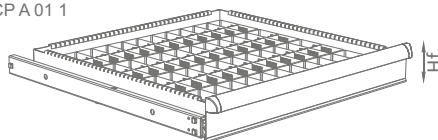

Ref. **115 075 C2**
HF 075-100
24x CPA 00
24x 200 2 02
24x CPA 02

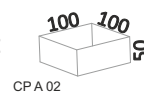
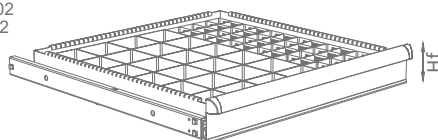

Ref. **115 075 C3**
HF 075-100
16x CPA 04
8x CPA 05

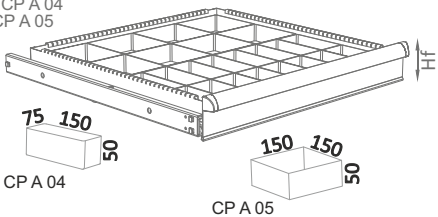

Ref. **115 075 C4**
HF 075-100
4x CPA 10
4x CPA 11
8x CPA 12

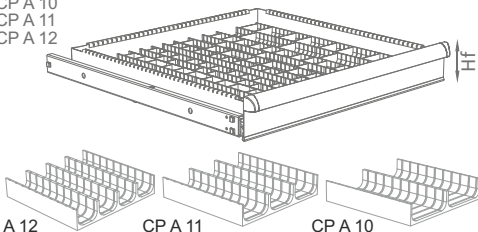

Ref. **115 125 C1**
HF 125-150
4x CP C 05
24x CP C 04

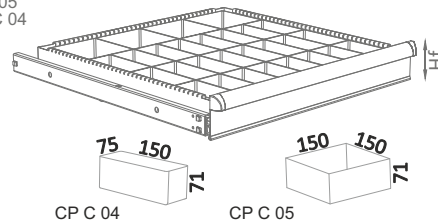

SERIE 119

Divisiones para cajones según altura frontal.
Séparateurs des tiroirs selon hauteur de frontal.
Drawer divisions according to front height.

Ref. **119 Hf D3**
HF 050-075-100-125-150-200-250

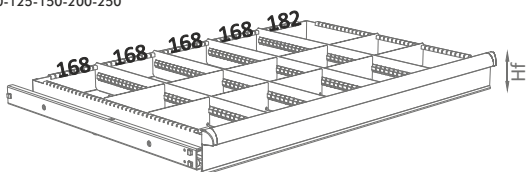

Ref. **119 Hf D4**
HF 050-075-100-125-150-200-250

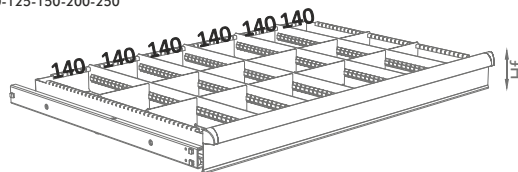

Ref. **119 Hf D5**
HF 050-075-100-125-150-200-250

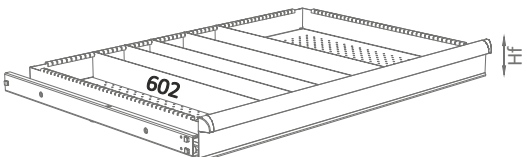

Ref. **119 Hf D6**
HF 050-075-100-125-150-200-250

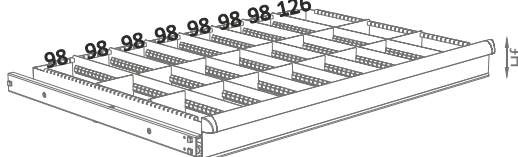

SERIE 119

Cubetas para cajones según altura frontal, sólo cajón 75 y 100.
Boîtes des tiroirs selon hauteur de frontal, tiroir 75 et 100 seulement.
Drawer trays according to front height, drawer 75 and 100 only.

Ref. **119 MP 01-02-03**
Hf 075-100

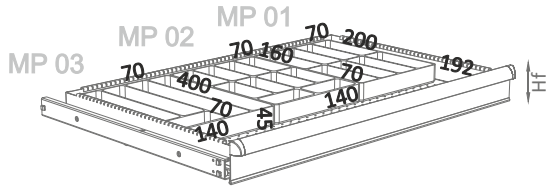

Ref. **119 MP 04-05-06**
Hf 075-100

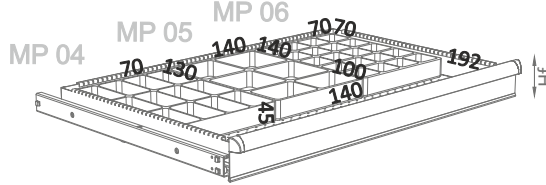

SERIE 122

Divisiones para cajones según altura frontal.
Séparateurs des tiroirs selon hauteur de frontal.
Drawer divisions according to front height.

Ref. **122 Hf D1**
Hf 075-100-125-150-200-250

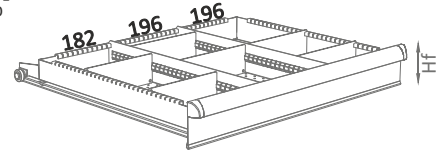

Ref. **122 Hf D2**
Hf 075-100-125-150-200-250

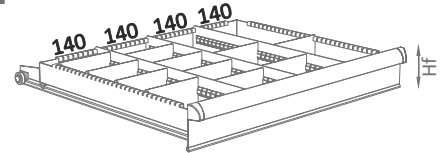

SERIE 123

Divisiones para cajones según altura frontal.
Séparateurs des tiroirs selon hauteur de frontal.
Drawer divisions according to front height.

Ref. **123 Hf D1**
Hf 075-100-125-150-200-250

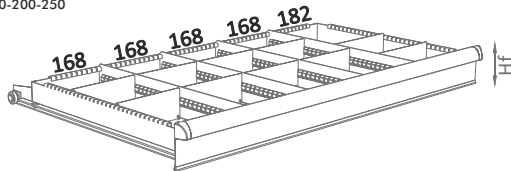

Ref. **123 Hf D2**
Hf 075-100-125-150-200-250

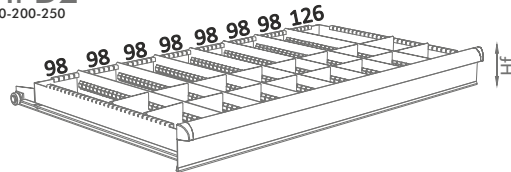

SERIE 135

Divisiones para cajones según altura frontal.
Séparateurs des tiroirs selon hauteur de frontal.
Drawer divisions according to front height.

Ref. **135 Hf D1**
Hf 075-100-125-150-200-250

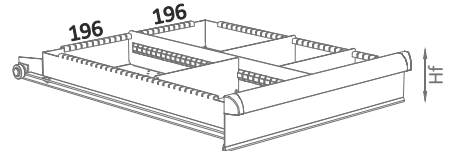

Ref. **135 Hf D2**
Hf 075-100-125-150-200-250

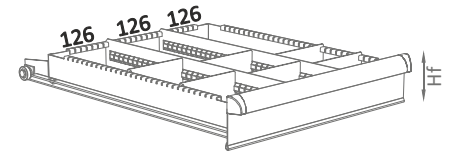

Divisiones para cajones según altura frontal.
Séparateurs des tiroirs selon hauteur de frontal.
Drawer divisions according to front height.

Ref. **143 Hf D3**
Hf 075-100-125-150-200-250

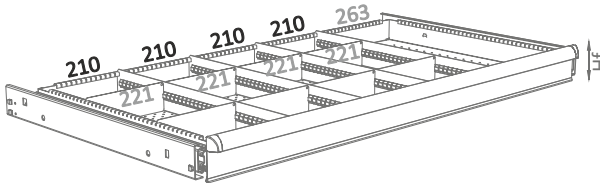

Ref. **143 Hf D5**
Hf 075-100-125-150-200-250

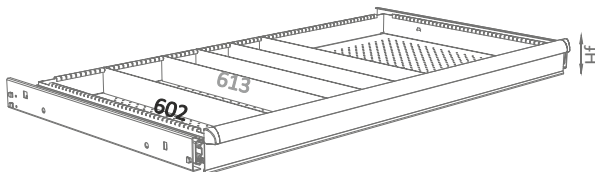

Ref. **143 Hf D4**
Hf 075-100-125-150-200-250

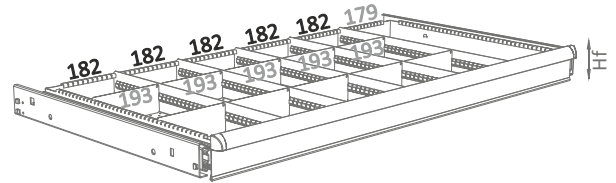

Ref. **143 Hf D6**
Hf 075-100-125-150-200-250

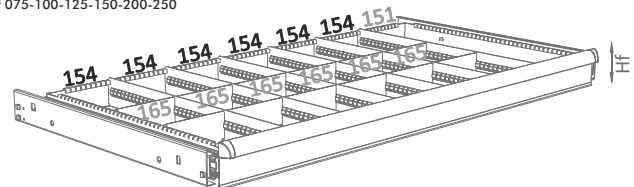

SERIE 143

Cubetas para cajones según altura frontal, sólo cajón 75 y 100.
Boîtes des tiroirs selon hauteur de frontal, tiroir 75 et 100 seulement.
Drawer trays according to front height, drawer 75 and 100 only.

Ref. **143 MP 01-02-03**
Hf 075-100

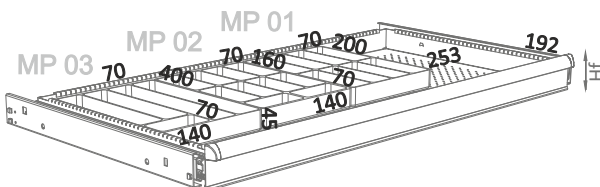

Ref. **143 MP 04-05-06**
Hf 075-100

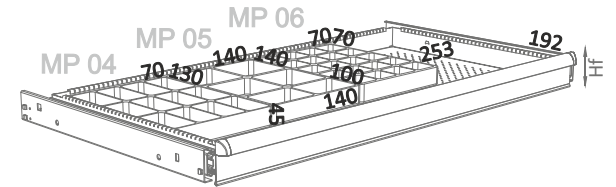

SERIE 143



CONSULTAR DISPONIBILIDAD MP 01-02-03-04-05-06 Hasta fin de existencias
VÉRIFIER LA DISPONIBILITÉ MP 01-02-03-04-05-06 Jusqu'à épuisement du stock
CHECK AVAILABILITY MP 01-02-03-04-05-06 Until end of stock

NOMENCLATURA CAJONES

NOMENCLATURE TIROIRS

DRAWERS NAMING

Ejemplo para la elección de cajones, válido para el resto de series.
Exemple de sélection de tiroirs, valable pour toutes les autres séries.
Example for the selection of drawers, valid for all other series.

SERIE SÉRIE SERIES
115/126/127
119
122
123
135

GUIAS GLISSIÈRES SLIDES

GS	GT	GT	GT
100 KG	50 KG	100 KG	200 KG

CAJONES TIROIRS DRAWERS

Hf Altura frontal.
Hauteur frontale.
Front height.

ex.

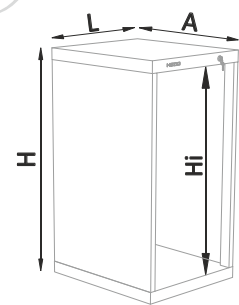

	LxAxH (mm)	Hi (mm)
135 1	515x600x700	600
135 2	515x600x1000	900
135 4	515x600x1400	1300

e 1 mm

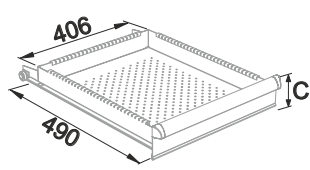

SERIE 135	C=75	C=100	C=125	C=150	C=200	C=250	C=300
	● x2	●	●	●	●	●	●

e 1 mm

SERIE 135 2
(515x600x1000)
Hi 900 mm

composición composition composition

SERIE	GUIAS	CAJONES
SÉRIE	GLISSIÈRES	TIROIRS
SERIE	SLIDES	DRAWERS
135	S100	C075
135	S100	C075
135	S100	C100
135	S100	C150
135	S100	C200
135	S100	C300

=Hi

SERIE 135 2

PEDIDO 2u. 135 S100 C075
COMMANDE 135 S100 C100
ORDER 135 S100 C150
135 S100 C200
135 S100 C300

CAJONES

TIROIRS

DRAWERS

Para SERIE 115/119/143/122/123/135/126/127.
Pour SÉRIE 115/119/143/122/123/135/126/127.
For SERIES 115/119/143/122/123/135/126/127.

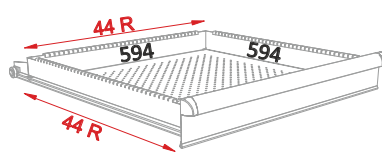

115-126-127

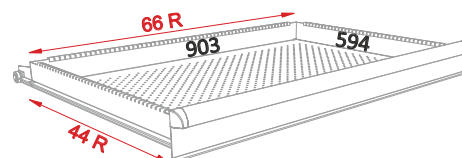

119

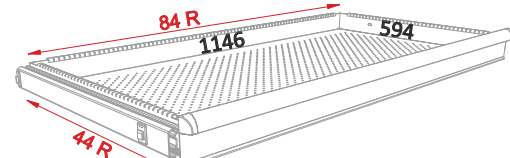

143

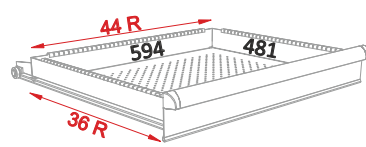

122

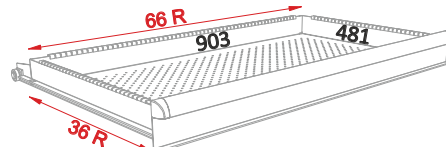

123

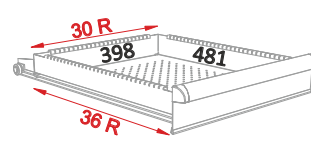

135

INFO: EX

Ejemplo para la elección de divisiones ranuradas y planas, válido para el resto de series.
 Exemple de sélection des séparations et intercalaires, valable pour toutes les autres séries.
 Example for the selection of divisions, valid for all other series.

**DIVISIONES DE CAJONES
 SEPARATIONS DES TIROIRS
 DRAWER DIVISORS**

SERIE 135 2

CAJON 135 S100 C150 Hf
 TIROIR
 DRAWER

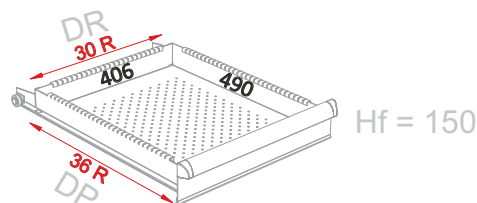

DR División ranurada. / **DP** Divisiones planas.
 Séparation rainurée. / Intercalaires.
 Slotted division. / Simple divisions.

SERIE 135

DR división ranurada séparations rainurées / slotted divisions

Longitud cajón: 406mm. Para tener 5 espacios, debo pedir 4 divisiones ranuradas.
 Longueur tiroir: 406mm. Pour avoir 5 espaces, je dois demander 4 divisions rainurées.
 Drawer length: 406mm. To have 5 spaces, I must ask 4 slotted divisors.

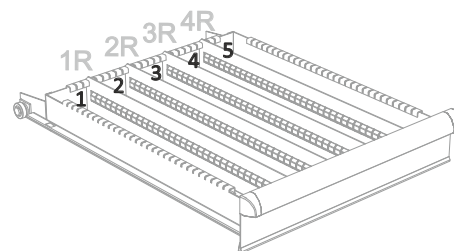

SERIE + Hf **Altura frontal.** + R
SÉRIE + Hf **Hauteur frontale.** + R
SERIE + Hf **Front height.** + R

DP división plana intercalaires / simple division

Para tener 25 espacios, debo pedir 20 divisiones planas.
 Pour avoir 25 espaces, je dois demander 20 séparations intercalaires.
 To have to 25 spaces, I must be ask 20 simple divisions.

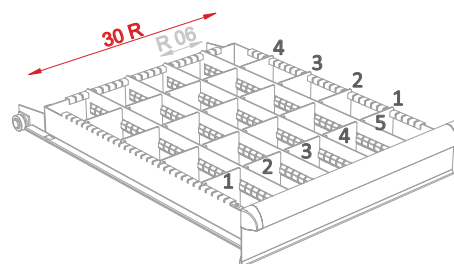

$4 \times 5 = 20$ unidades / unités / units
 $\frac{30R}{5 \text{ espacios}} = R 06$
 5 espacios / places / space

Hf **Altura frontal.** + R
 Hauteur frontale.
 Front height.

PEDIDO	SERIE 135 2	cajón tiroir / drawer
COMMANDE	1u. 135 S100 C150	división ranurada / division rainurée / slotted division DR
ORDER	4u. 135 150 R	división plana / intercalaire / simple division DP
	20u. 150 06	

DR posición position / position

Ubicación de las divisiones ranuradas y las divisiones planas.
 Emplacement pour les divisions rainurées et les intercalaires.
 Slotted and simple divisions emplacement.

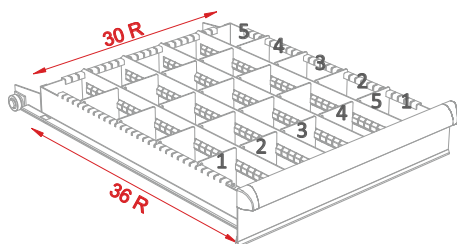

DR
 $\frac{30R}{5 \text{ espacios}} = 6$
 5 espacios / places / space
 ranuras ocupadas en horizontal / rainures occupées longitudinales / longitudinal occupied grooves

DP
 $\frac{36R}{5 \text{ espacios}} = 7$
 5 espacios / places / space
 ranuras ocupadas en vertical / rainures occupées verticales / vertical occupied grooves

DIVISIONES INTERCALAIRES DIVISORS

C50

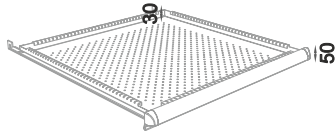

CAJON TIROIR DRAWER C50 Hd 30 mm

DIVISIONES RANURADAS
DIVISIONS RAINURÉES
SLOTTED DIVISORS

SERIE 115,119

ref.	LxAxH
050 R	610x14x30 mm

DIVISIONES PLANAS
INTERCALAIRES
SIMPLE DIVISORS

ref.	Hf +R	Lu	Ld
050 04	42 mm	53 mm	
050 05	56 mm	67 mm	
050 06	70 mm	81 mm	
050 07	84 mm	95 mm	
050 08	98 mm	109 mm	
050 09	112 mm	123 mm	
050 10	126 mm	137 mm	
050 11	140 mm	151 mm	
050 12	154 mm	165 mm	
050 13	168 mm	179 mm	
050 14	182 mm	193 mm	
050 15	196 mm	207 mm	
050 16	210 mm	221 mm	
050 17	224 mm	235 mm	
050 18	238 mm	249 mm	
050 19	252 mm	263 mm	
050 20	266 mm	277 mm	
050 21	280 mm	291 mm	
050 22	294 mm	305 mm	
050 23	308 mm	319 mm	
050 24	322 mm	333 mm	
050 25	336 mm	347 mm	
050 26	350 mm	361 mm	
050 27	364 mm	375 mm	
050 28	378 mm	389 mm	
050 29	392 mm	403 mm	
050 30	406 mm	417 mm	
050 31	420 mm	431 mm	
050 32	434 mm	445 mm	
050 33	448 mm	459 mm	
050 34	462 mm	473 mm	
050 35	476 mm	487 mm	
050 36	490 mm	501 mm	
050 37	504 mm	515 mm	
050 38	518 mm	529 mm	
050 39	532 mm	543 mm	
050 40	546 mm	557 mm	
050 41	560 mm	571 mm	
050 42	574 mm	585 mm	
050 43	588 mm	599 mm	
050 44	602 mm	613 mm	

C75

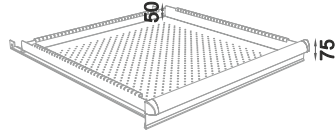

CAJON TIROIR DRAWER C75 Hd 50 mm

DIVISIONES RANURADAS
DIVISIONS RAINURÉES
SLOTTED DIVISORS

SERIE 115,119,143

ref.	LxAxH
075 R	610x14x45 mm

SERIE 135,122,123

ref.	LxAxH
135 075 R	498x14x45 mm

DIVISIONES PLANAS
INTERCALAIRES
SIMPLE DIVISORS

ref.	Hf +R	Lu	Ld
075 04	42 mm	53 mm	
075 05	56 mm	67 mm	
075 06	70 mm	81 mm	
075 07	84 mm	95 mm	
075 08	98 mm	109 mm	
075 09	112 mm	123 mm	
075 10	126 mm	137 mm	
075 11	140 mm	151 mm	
075 12	154 mm	165 mm	
075 13	168 mm	179 mm	
075 14	182 mm	193 mm	
075 15	196 mm	207 mm	
075 16	210 mm	221 mm	
075 17	224 mm	235 mm	
075 18	238 mm	249 mm	
075 19	252 mm	263 mm	
075 20	266 mm	277 mm	
075 21	280 mm	291 mm	
075 22	294 mm	305 mm	
075 23	308 mm	319 mm	
075 24	322 mm	333 mm	
075 25	336 mm	347 mm	
075 26	350 mm	361 mm	
075 27	364 mm	375 mm	
075 28	378 mm	389 mm	
075 29	392 mm	403 mm	
075 30	406 mm	417 mm	
075 31	420 mm	431 mm	
075 32	434 mm	445 mm	
075 33	448 mm	459 mm	
075 34	462 mm	473 mm	
075 35	476 mm	487 mm	
075 36	490 mm	501 mm	
075 37	504 mm	515 mm	
075 38	518 mm	529 mm	
075 39	532 mm	543 mm	
075 40	546 mm	557 mm	
075 41	560 mm	571 mm	
075 42	574 mm	585 mm	
075 43	588 mm	599 mm	
075 44	602 mm	613 mm	

C100

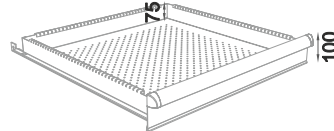

CAJON TIROIR DRAWER C100 Hd 62 mm

DIVISIONES RANURADAS
DIVISIONS RAINURÉES
SLOTTED DIVISORS

SERIE 115,119,143

ref.	LxAxH
100 R	610x14x70 mm

SERIE 135,122,123

ref.	LxAxH
135 100 R	498x14x63 mm

DIVISIONES PLANAS
INTERCALAIRES
SIMPLE DIVISORS

ref.	Hf +R	Lu	Ld
100 04	42 mm	53 mm	
100 05	56 mm	67 mm	
100 06	70 mm	81 mm	
100 07	84 mm	95 mm	
100 08	98 mm	109 mm	
100 09	112 mm	123 mm	
100 10	126 mm	137 mm	
100 11	140 mm	151 mm	
100 12	154 mm	165 mm	
100 13	168 mm	179 mm	
100 14	182 mm	193 mm	
100 15	196 mm	207 mm	
100 16	210 mm	221 mm	
100 17	224 mm	235 mm	
100 18	238 mm	249 mm	
100 19	252 mm	263 mm	
100 20	266 mm	277 mm	
100 21	280 mm	291 mm	
100 22	294 mm	305 mm	
100 23	308 mm	319 mm	
100 24	322 mm	333 mm	
100 25	336 mm	347 mm	
100 26	350 mm	361 mm	
100 27	364 mm	375 mm	
100 28	378 mm	389 mm	
100 29	392 mm	403 mm	
100 30	406 mm	417 mm	
100 31	420 mm	431 mm	
100 32	434 mm	445 mm	
100 33	448 mm	459 mm	
100 34	462 mm	473 mm	
100 35	476 mm	487 mm	
100 36	490 mm	501 mm	
100 37	504 mm	515 mm	
100 38	518 mm	529 mm	
100 39	532 mm	543 mm	
100 40	546 mm	557 mm	
100 41	560 mm	571 mm	
100 42	574 mm	585 mm	
100 43	588 mm	599 mm	
100 44	602 mm	613 mm	

C125

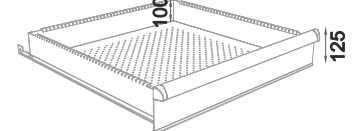

CAJON TIROIR DRAWER C125 Hd 87 mm

DIVISIONES RANURADAS
DIVISIONS RAINURÉES
SLOTTED DIVISORS

SERIE 115,119,143

ref.	LxAxH
125 R	610x14x95 mm

SERIE 135,122,123

ref.	LxAxH
135 125 R	498x14x88 mm

DIVISIONES PLANAS
INTERCALAIRES
SIMPLE DIVISORS

ref.	Hf +R	Lu	Ld
125 04	42 mm	53 mm	
125 05	56 mm	67 mm	
125 06	70 mm	81 mm	
125 07	84 mm	95 mm	
125 08	98 mm	109 mm	
125 09	112 mm	123 mm	
125 10	126 mm	137 mm	
125 11	140 mm	151 mm	
125 12	154 mm	165 mm	
125 13	168 mm	179 mm	
125 14	182 mm	193 mm	
125 15	196 mm	207 mm	
125 16	210 mm	221 mm	
125 17	224 mm	235 mm	
125 18	238 mm	249 mm	
125 19	252 mm	263 mm	
125 20	266 mm	277 mm	
125 21	280 mm	291 mm	
125 22	294 mm	305 mm	
125 23	308 mm	319 mm	
125 24	322 mm	333 mm	
125 25	336 mm	347 mm	
125 26	350 mm	361 mm	
125 27	364 mm	375 mm	
125 28	378 mm	389 mm	
125 29	392 mm	403 mm	
125 30	406 mm	417 mm	
125 31	420 mm	431 mm	
125 32	434 mm	445 mm	
125 33	448 mm	459 mm	
125 34	462 mm	473 mm	
125 35	476 mm	487 mm	
125 36	490 mm	501 mm	
125 37	504 mm	515 mm	
125 38	518 mm	529 mm	
125 39	532 mm	543 mm	
125 40	546 mm	557 mm	
125 41	560 mm	571 mm	
125 42	574 mm	585 mm	
125 43	588 mm	599 mm	
125 44	602 mm	613 mm	

Hf Altura frontal cajón.
Hauteur frontale tiroir.
Drawer front height.

R Ranuras ocupadas.
Rainures occupées.
Slots to be used.

Lu Longitud útil.
Longueur utile.
Useful length width.

Ld Longitud real de la pieza.
Longueur réelle de la pièce.
Real length width from piece.

DIVISIONES SEPARATIONS DIVISORS

C150

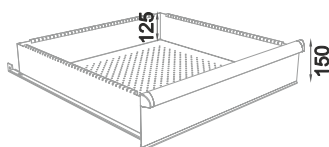

CAJON
TIROIR
DRAWER **C150** Hd 112 mm

DIVISIONES RANURADAS
DIVISIONS RAINURÉES
SLOTTED DIVISORS

SERIE 115,119,143

ref.	LxAxH
150 R	610x14x120 mm

SERIE 135,122,123

ref.	LxAxH
135 150 R	498x14x113 mm

DIVISIONES PLANAS
INTERCALAIRES
SIMPLE DIVISORS

ref.	Hf +R	Lu	Ld
150 04	42 mm	53 mm	
150 05	56 mm	67 mm	
150 06	70 mm	81 mm	
150 07	84 mm	95 mm	
150 08	98 mm	109 mm	
150 09	112 mm	123 mm	
150 10	126 mm	137 mm	
150 11	140 mm	151 mm	
150 12	154 mm	165 mm	
150 13	168 mm	179 mm	
150 14	182 mm	193 mm	
150 15	196 mm	207 mm	
150 16	210 mm	221 mm	
150 17	224 mm	235 mm	
150 18	238 mm	249 mm	
150 19	252 mm	263 mm	
150 20	266 mm	277 mm	
150 21	280 mm	291 mm	
150 22	294 mm	305 mm	
150 23	308 mm	319 mm	
150 24	322 mm	333 mm	
150 25	336 mm	347 mm	
150 26	350 mm	361 mm	
150 27	364 mm	375 mm	
150 28	378 mm	389 mm	
150 29	392 mm	403 mm	
150 30	406 mm	417 mm	
150 31	420 mm	431 mm	
150 32	434 mm	445 mm	
150 33	448 mm	459 mm	
150 34	462 mm	473 mm	
150 35	476 mm	487 mm	
150 36	490 mm	501 mm	
150 37	504 mm	515 mm	
150 38	518 mm	529 mm	
150 39	532 mm	543 mm	
150 40	546 mm	557 mm	
150 41	560 mm	571 mm	
150 42	574 mm	585 mm	
150 43	588 mm	599 mm	
150 44	602 mm	613 mm	

C200

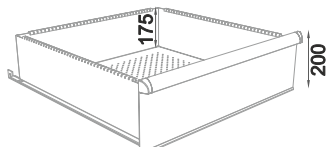

CAJON
TIROIR
DRAWER **C200** Hd 162 mm

DIVISIONES RANURADAS
DIVISIONS RAINURÉES
SLOTTED DIVISORS

SERIE 115,119,143

ref.	LxAxH
200 R	610x14x170 mm

SERIE 135,122,123

ref.	LxAxH
135 200 R	498x14x163 mm

DIVISIONES PLANAS
INTERCALAIRES
SIMPLE DIVISORS

ref.	Hf +R	Lu	Ld
200 04	42 mm	53 mm	
200 05	56 mm	67 mm	
200 06	70 mm	81 mm	
200 07	84 mm	95 mm	
200 08	98 mm	109 mm	
200 09	112 mm	123 mm	
200 10	126 mm	137 mm	
200 11	140 mm	151 mm	
200 12	154 mm	165 mm	
200 13	168 mm	179 mm	
200 14	182 mm	193 mm	
200 15	196 mm	207 mm	
200 16	210 mm	221 mm	
200 17	224 mm	235 mm	
200 18	238 mm	249 mm	
200 19	252 mm	263 mm	
200 20	266 mm	277 mm	
200 21	280 mm	291 mm	
200 22	294 mm	305 mm	
200 23	308 mm	319 mm	
200 24	322 mm	333 mm	
200 25	336 mm	347 mm	
200 26	350 mm	361 mm	
200 27	364 mm	375 mm	
200 28	378 mm	389 mm	
200 29	392 mm	403 mm	
200 30	406 mm	417 mm	
200 31	420 mm	431 mm	
200 32	434 mm	445 mm	
200 33	448 mm	459 mm	
200 34	462 mm	473 mm	
200 35	476 mm	487 mm	
200 36	490 mm	501 mm	
200 37	504 mm	515 mm	
200 38	518 mm	529 mm	
200 39	532 mm	543 mm	
200 40	546 mm	557 mm	
200 41	560 mm	571 mm	
200 42	574 mm	585 mm	
200 43	588 mm	599 mm	
200 44	602 mm	613 mm	

C250

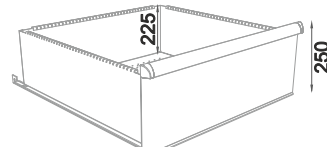

CAJON
TIROIR
DRAWER **C250** Hd 212 mm

DIVISIONES RANURADAS
DIVISIONS RAINURÉES
SLOTTED DIVISORS

SERIE 115,119,143

ref.	LxAxH
250 R	610x14x220 mm

SERIE 135,122,123

ref.	LxAxH
135 250 R	498x14x213 mm

DIVISIONES PLANAS
INTERCALAIRES
SIMPLE DIVISORS

ref.	Hf +R	Lu	Ld
250 04	42 mm	53 mm	
250 05	56 mm	67 mm	
250 06	70 mm	81 mm	
250 07	84 mm	95 mm	
250 08	98 mm	109 mm	
250 09	112 mm	123 mm	
250 10	126 mm	137 mm	
250 11	140 mm	151 mm	
250 12	154 mm	165 mm	
250 13	168 mm	179 mm	
250 14	182 mm	193 mm	
250 15	196 mm	207 mm	
250 16	210 mm	221 mm	
250 17	224 mm	235 mm	
250 18	238 mm	249 mm	
250 19	252 mm	263 mm	
250 20	266 mm	277 mm	
250 21	280 mm	291 mm	
250 22	294 mm	305 mm	
250 23	308 mm	319 mm	
250 24	322 mm	333 mm	
250 25	336 mm	347 mm	
250 26	350 mm	361 mm	
250 27	364 mm	375 mm	
250 28	378 mm	389 mm	
250 29	392 mm	403 mm	
250 30	406 mm	417 mm	
250 31	420 mm	431 mm	
250 32	434 mm	445 mm	
250 33	448 mm	459 mm	
250 34	462 mm	473 mm	
250 35	476 mm	487 mm	
250 36	490 mm	501 mm	
250 37	504 mm	515 mm	
250 38	518 mm	529 mm	
250 39	532 mm	543 mm	
250 40	546 mm	557 mm	
250 41	560 mm	571 mm	
250 42	574 mm	585 mm	
250 43	588 mm	599 mm	
250 44	602 mm	613 mm	

C300

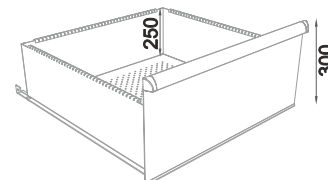

CAJON
TIROIR
DRAWER **C300** Hd 212 mm

DIVISIONES RANURADAS
DIVISIONS RAINURÉES
SLOTTED DIVISORS

SERIE 127

ref.	LxAxH
300 R	610x14x220 mm

DIVISIONES PLANAS
INTERCALAIRES
SIMPLE DIVISORS

ref.	Hf +R	Lu	Ld
300 04	42 mm	53 mm	
300 05	56 mm	67 mm	
300 06	70 mm	81 mm	
300 07	84 mm	95 mm	
300 08	98 mm	109 mm	
300 09	112 mm	123 mm	
300 10	126 mm	137 mm	
300 11	140 mm	151 mm	
300 12	154 mm	165 mm	
300 13	168 mm	179 mm	
300 14	182 mm	193 mm	
300 15	196 mm	207 mm	
300 16	210 mm	221 mm	
300 17	224 mm	235 mm	
300 18	238 mm	249 mm	
300 19	252 mm	263 mm	
300 20	266 mm	277 mm	
300 21	280 mm	291 mm	
300 22	294 mm	305 mm	
300 23	308 mm	319 mm	
300 24	322 mm	333 mm	
300 25	336 mm	347 mm	
300 26	350 mm	361 mm	
300 27	364 mm	375 mm	
300 28	378 mm	389 mm	
300 29	392 mm	403 mm	
300 30	406 mm	417 mm	
300 31	420 mm	431 mm	
300 32	434 mm	445 mm	
300 33	448 mm	459 mm	
300 34	462 mm	473 mm	
300 35	476 mm	487 mm	
300 36	490 mm	501 mm	
300 37	504 mm	515 mm	
300 38	518 mm	529 mm	
300 39	532 mm	543 mm	
300 40	546 mm	557 mm	
300 41	560 mm	571 mm	
300 42	574 mm	585 mm	
300 43	588 mm	599 mm	
300 44	602 mm	613 mm	



Los divisiones se sirven en acero galvanizado.
Les séparations sont fournies en acier galvanisé.
The divisions are supplied in galvanized steel.