



SERIE 115



SERIE 119



SERIE 143

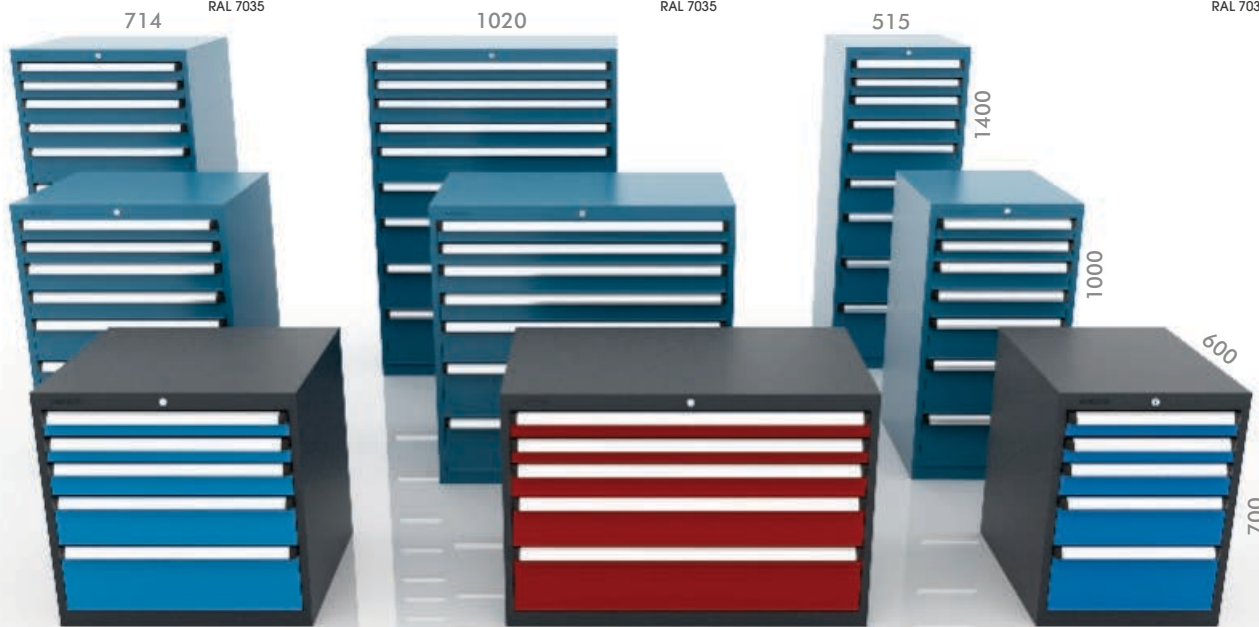

SERIE 122



SERIE 123



SERIE 135



**accesorios**  
accessoires  
accessories

Zócalo  
Socle  
Stand



Base con ruedas  
Socle avec roues  
Wheeled stand



Bastidor portaconos  
Châssis porte-cônes  
Tool holder frame

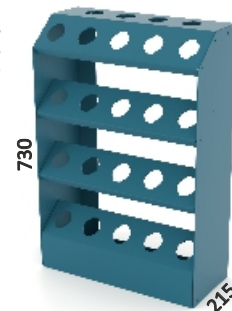

Ref. CE P 1



Suplemento encimera  
Supplément plan de travail  
Worktop supplement

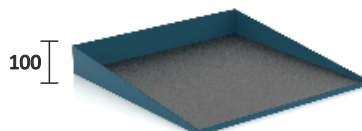

 Cierre electrónico  
Verrou électronique  
Electronic locking



Los cajones no incluyen divisiones.  
Les tiroirs n'incluent pas les séparations.  
Divisions for drawers no included.



Para colores no estándar hay coste adicional (consultar condiciones).  
Pour les couleurs non standard il y a un coût supplémentaire (consulter les conditions).  
For non-standard colours there is an additional cost (consult conditions).



SERIE 136 2

SERIE 400

SERIE 106

información  
information  
information

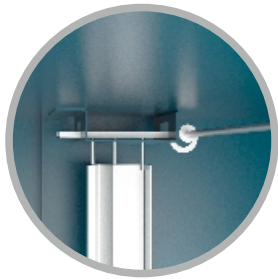

Sistema antivuelco.  
Système anti-renversement.  
Anti-roll system.

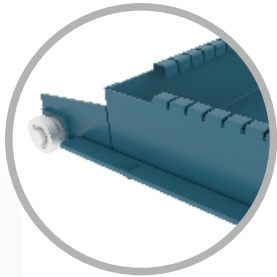

**GS** Apertura 90%.  
Ouverture 90%.  
90% opening.

Guías simples o telescópicas.  
Glissières simples ou télescopiques.  
Simple or telescopic slides.

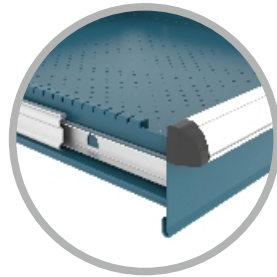

**GT** Apertura 100%.  
Ouverture 100%.  
100% opening.

**BE** Bandeja extraíble con GS o GT según cajones.  
Plateau amovible avec GS ou GT selon les tiroirs.  
Removable tray with GS or GT according to drawers.

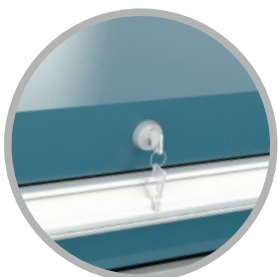

Cierre centralizado.  
Verrouillage centralisé.  
Central locking.

- ES**
- Gran variedad de medidas y configuraciones.
  - Diseño robusto y resistente.
  - Cierre centralizado.
  - Sistema antivuelco.
  - Asas de aluminio con portaetiquetas.
  - Cajones ranurados con separadores para la clasificación.
  - Cierre electrónico. Sistema RFID opcional.
  - Plazo de entrega 10 días laborables.
  - Color estándar azul martelé posibilidad colores en opción.

- FR**
- Grande variété de tailles et configurations.
  - Conception robuste et résistante.
  - Verrouillage centralisé.
  - Système anti-renversement.
  - Poignées en aluminium avec porte-étiquettes.
  - Tiroirs rainurés avec séparateurs pour la classification.
  - Système RFID en option.
  - Délai de livraison 10 jours ouvrables.
  - Couleur standard bleu martelé possibilité teintes en option.

- EN**
- Wide range of sizes and configurations.
  - Strong and resistant design.
  - Central locking.
  - Anti-roll system.
  - Aluminum handles with label holders.
  - Grooved drawers with dividers.
  - Optional RFID system.
  - Delivery time 10 working days.
  - Standard colour hammered blue possibility optional colours.

## SERIE 115

Cierre centralizado.  
Verrouillage centralisé.  
Central locking.



Accesorios opcionales  
Accessoires optionnels  
Optional accessories

Sistema antivuelco.  
Système anti-renversement.  
Anti-roll system.

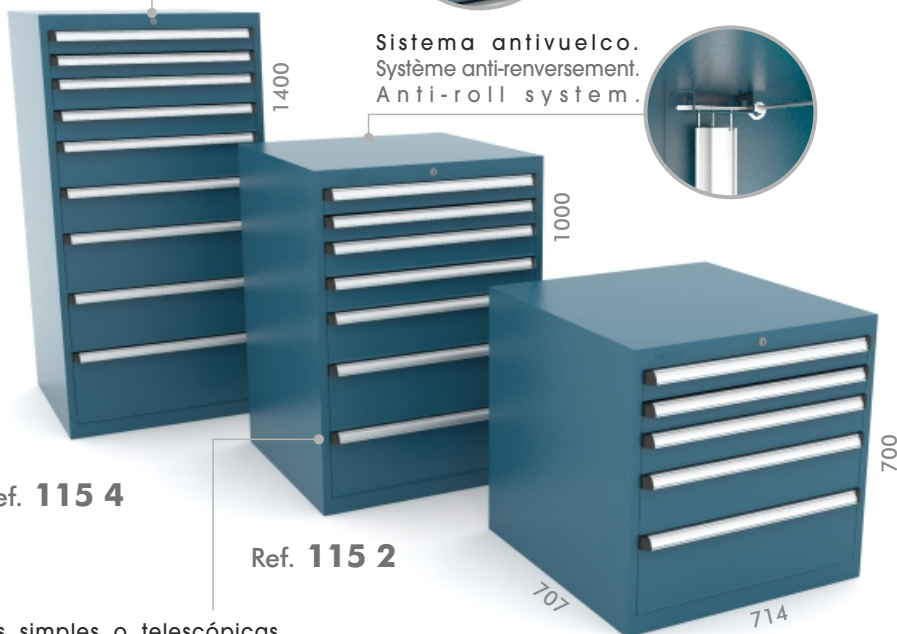
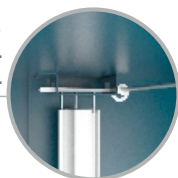

Ref. 115 4

Ref. 115 2

Ref. 115 1

Guías simples o telescópicas.  
Glissières simples ou télescopiques.  
Simple or telescopic slides.

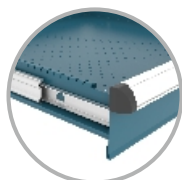
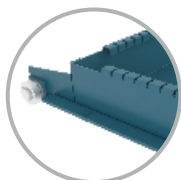

**GS** Apertura 90%.  
Ouverture 90%.  
90% opening.

**GT** Apertura 100%.  
Ouverture 100%.  
100% opening.

**BE**

Bandeja extraíble con GS o GT según cajones.  
Plateau coulissant avec GS ou GT selon les tiroirs.  
Removable tray with GS or GT according to drawers.

Ref. 115 4

Ref. 115 1

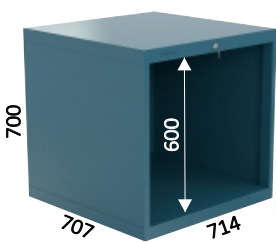

42 Kg  
750 x 750 x 900 mm

Ref. 115 2

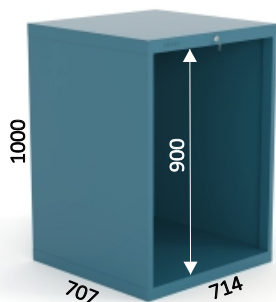

49 Kg  
750 x 750 x 1200 mm

1400



56 Kg  
750 x 750 x 1600 mm

Ref. 115 Z  
3,8 Kg

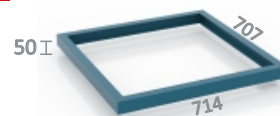

Ref. 115 S M  
18,7 Kg

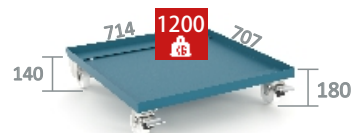

Ref. 115 S E  
7 Kg

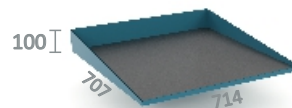

Ref. 115 B ISO 50  
Ref. 115 B HSK 100  
22 Kg

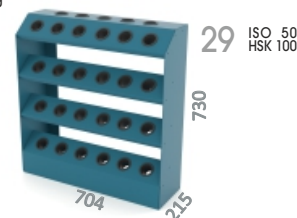

Ref. 115 B ISO 40  
Ref. 115 B HSK 50  
Ref. 115 B HSK 63  
Ref. 115 B HSK 80  
22 Kg

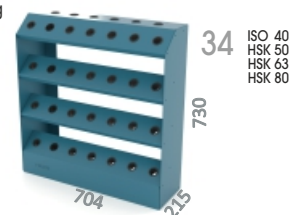

Ref. CE P 1



REF. CE P 1  
REF. CE P 1 TM  
REF. CE P 1 TU



Cierre electrónico  
Verrou électronique  
Electronic locking



## Cajones / Tiroirs / Drawers

	GT 50	GS 100	GT 100	GT 200	GT 200
C=75	● 115 T50 C75 6Kg	● 115 S100 C75 9Kg	● 115 T100 C75 11Kg	● 115 T200 C75 15Kg	25 PORTACONOS 25 PORTE-CÔNES 25 TOOL HOLDER
C=100	● 115 T50 C100 7Kg	● 115 S100 C100 10,5Kg	● 115 T100 C100 12,5Kg	● 115 T200 C100 16Kg	
C=125	● 115 T50 C125 7,5Kg	● 115 S100 C125 11Kg	● 115 T100 C125 13Kg	● 115 T200 C125 17Kg	
C=150	● 115 T50 C150 8,5Kg	● 115 S100 C150 12,5Kg	● 115 T100 C150 13,5Kg	● 115 T200 C150 18Kg	
C=200	● 115 T50 C200 9,5Kg	● 115 S100 C200 13Kg	● 115 T100 C200 14,5Kg	● 115 T200 C200 19,5Kg	
C=250	● 115 T50 C250 10,5Kg	● 115 S100 C250 14Kg	● 115 T100 C250 15,5Kg	● 115 T200 C250 20,5Kg	
C=300				● 115 T200 ISO 40	
				● 115 T200 HSK 50	
				● 115 T200 HSK 63	
				● 115 T200 HSK 80	
				● 115 T200 ISO 50	
				● 115 T200 HSK 100 28Kg	
	1 mm	1.5 mm	1.5 mm	1.5 mm	1.5 mm

Ref. **115 1**

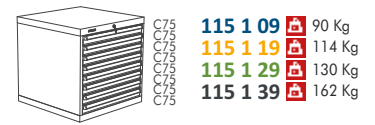
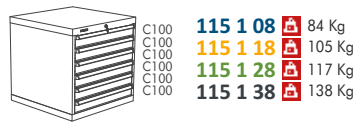
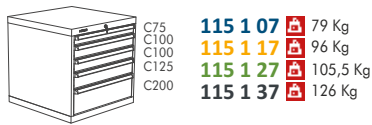
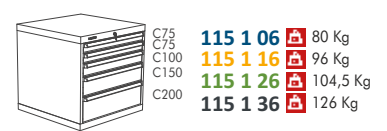
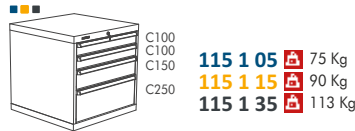
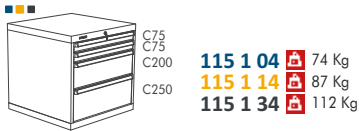
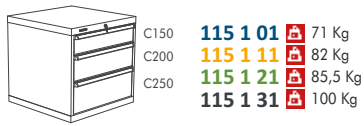

Ref. **115 2**

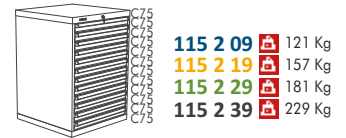
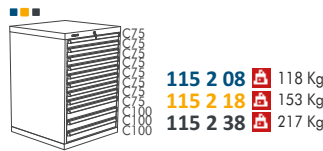
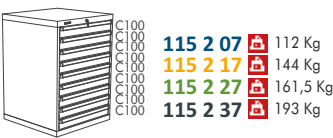
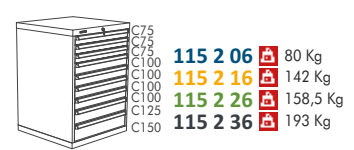
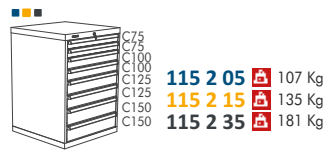
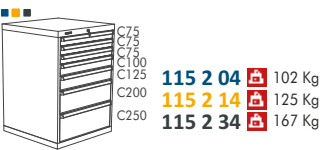

Ref. **115 4**

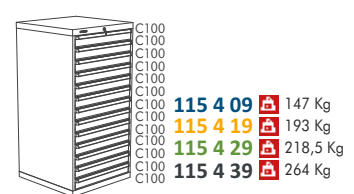
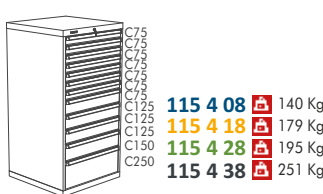
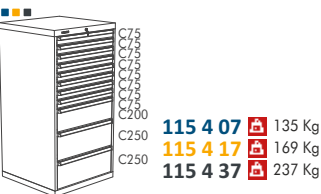
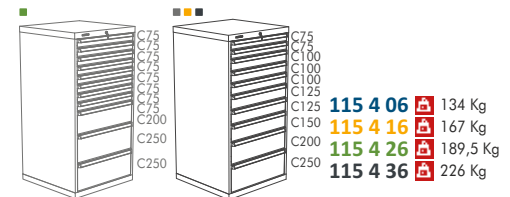
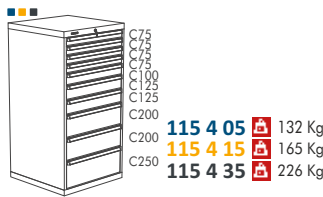
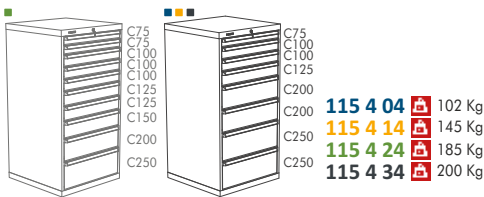
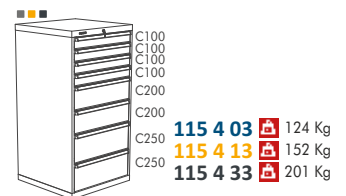
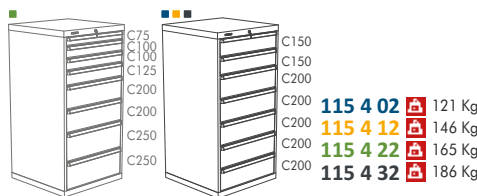
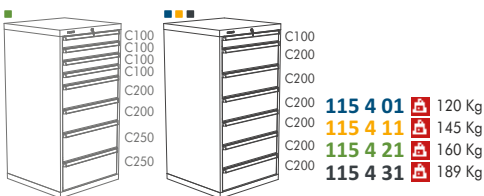



Ref. 119 1

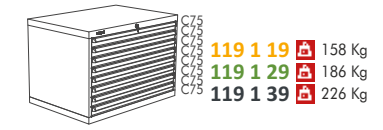
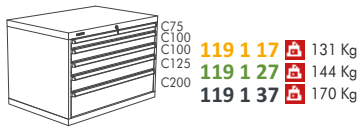
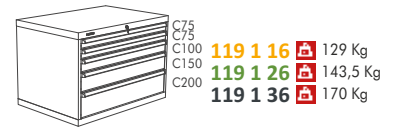
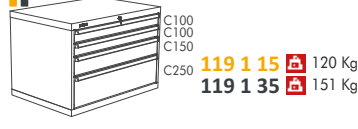
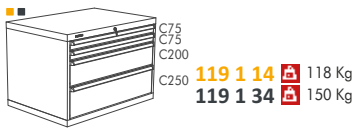
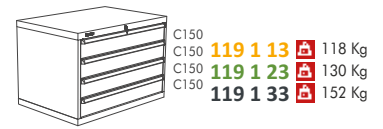
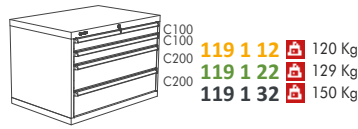
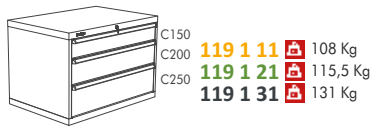

Ref. 119 2

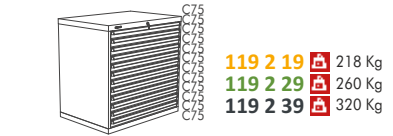
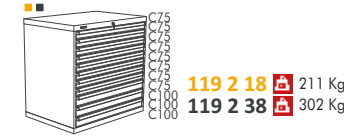
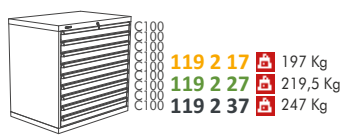
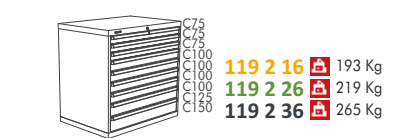
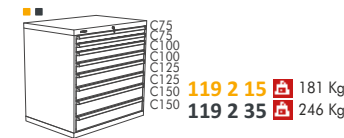
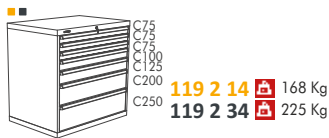
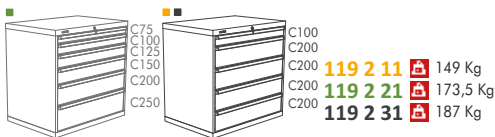

Ref. 119 4

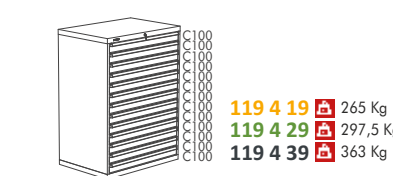
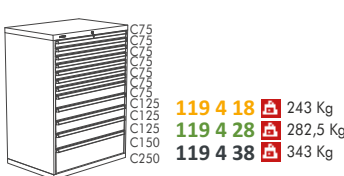
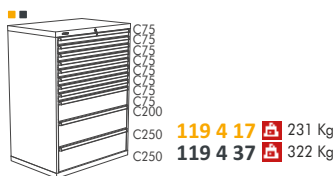
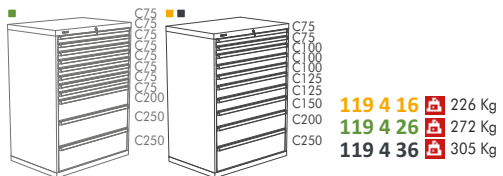
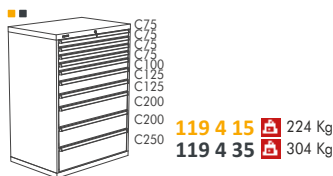
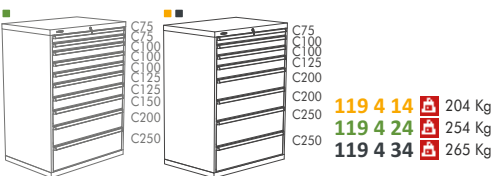
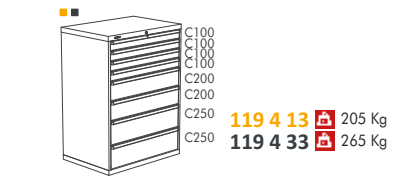
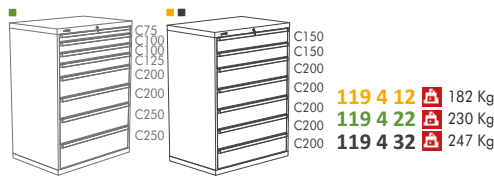
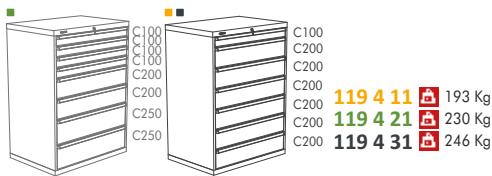

**SERIE 143**

Accesorios opcionales  
Accessoires optionnels  
Optional accessories

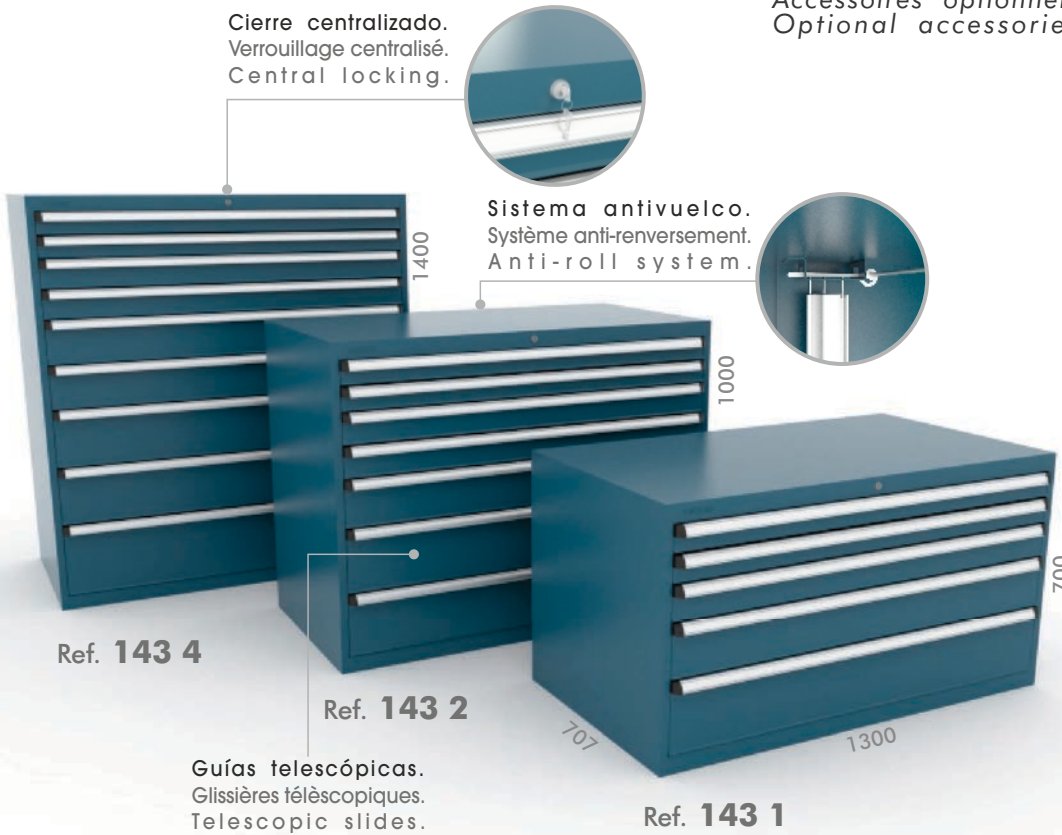

Cierre centralizado.  
Verrouillage centralisé.  
Central locking.

Sistema antivuelco.  
Système anti-renversement.  
Anti-roll system.

Guías telescópicas.  
Glissières télescópiques.  
Telescopic slides.

Ref. 143 Z  
7,7 Kg

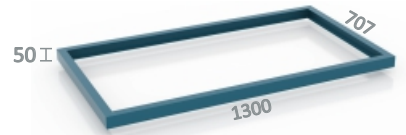

Ref. 143 S M  
33 Kg

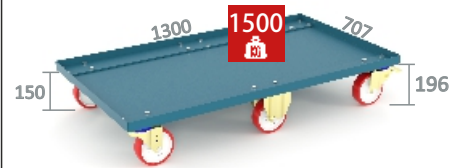

Ref. 143 S E  
13 Kg

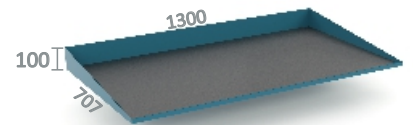

**BE** Bandeja extraíble con GT.  
Plateau coulissant avec GT.  
Sliding shelf with GT.

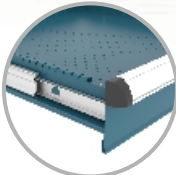

**GT** Apertura 100%.  
Ouverture 100%.  
100% opening.

Ref. 143 4

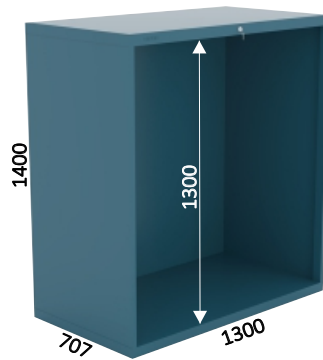

Ref. CE P 1



REF. CE P 1  
REF. CE P 1 TM  
REF. CE P 1 TU



Cierre electrónico  
Verrou électronique  
Electronic locking

Ref. 143 1

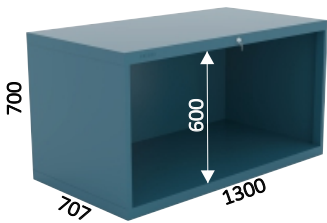

68,8 Kg  
1350 x 750 x 900 mm

Ref. 143 2

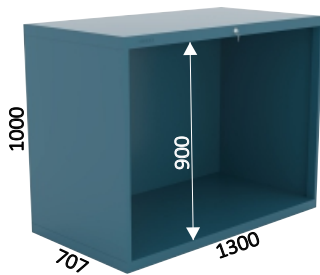

79 Kg  
1350 x 750 x 1200 mm

1400

87,2 Kg  
1350 x 750 x 1600 mm

Cajones / Tiroirs / Drawers

SERIE 143	C	●	GT 200	
			Ref.	Peso
	C=75	●	143 T200 C75	27,4Kg
	C=100	●	143 T200 C100	28,7Kg
	C=125	●	143 T200 C125	30Kg
	C=150	●	143 T200 C150	31,2Kg
	C=200	●	143 T200 C200	32,5Kg
	C=250	●	143 T200 C250	34,4Kg
		■	1.5 mm	

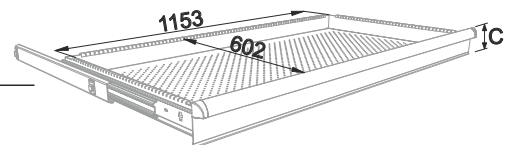

Los cajones no incluyen divisiones.  
Les tiroirs n'incluent pas les séparations.  
Divisions for drawers no included.



Las divisiones se sirven en acero galvanizado.  
Les séparations sont fournies en acier galvanisé.  
The divisions are supplied in galvanised steel.

Ref. **143 1**



C150  
C200  
C250

**143 1 31** 170 Kg

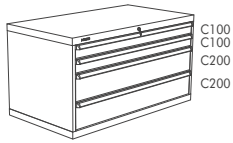

C100  
C100  
C200  
C200

**143 1 32** 195 Kg

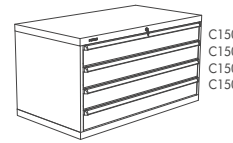

C150  
C150  
C150  
C150

**143 1 33** 198 Kg



C75  
C75  
C200  
C250

**143 1 34** 195 Kg



C100  
C100  
C150  
C250

**143 1 35** 196 Kg

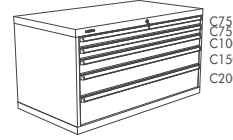

C75  
C75  
C100  
C150  
C200

**143 1 36** 221 Kg

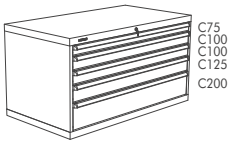

C75  
C100  
C100  
C125  
C200

**143 1 37** 221 Kg

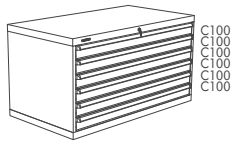

C100  
C100  
C100  
C100  
C100  
C100

**143 1 38** 246 Kg

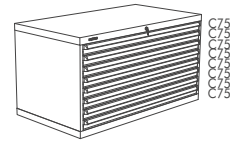

C75  
C75  
C75  
C75  
C75  
C75

**143 1 39** 294 Kg

Ref. **143 2**



C100  
C200  
C200  
C200  
C200

**143 2 31** 243 Kg



C75  
C100  
C125  
C150  
C200  
C250

**143 2 32** 266 Kg



C150  
C150  
C150  
C150  
C150

**143 2 33** 272 Kg

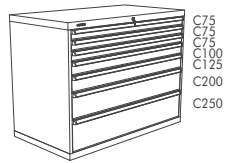

C75  
C75  
C75  
C100  
C125  
C200  
C250

**143 2 34** 293 Kg

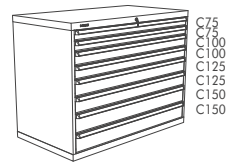

C75  
C100  
C100  
C125  
C125  
C150  
C150

**143 2 35** 320 Kg

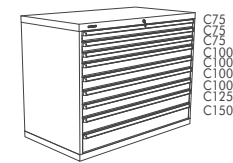

C75  
C75  
C75  
C100  
C100  
C100  
C125  
C150

**143 2 36** 345 Kg

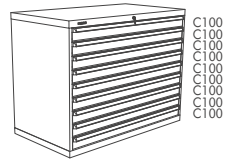

C100  
C100  
C100  
C100  
C100  
C100  
C100  
C100

**143 2 37** 321 Kg

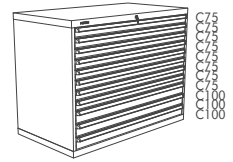

C75  
C75  
C75  
C75  
C75  
C75  
C75  
C75  
C75  
C100  
C100

**143 2 38** 393 Kg

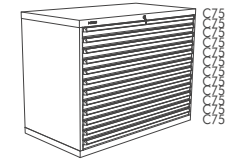

C75  
C75  
C75  
C75  
C75  
C75  
C75  
C75  
C75  
C75

**143 2 39** 416 Kg

Ref. **143 4**

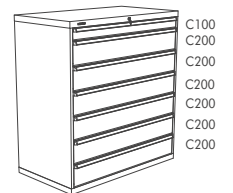

C100  
C150  
C200  
C200  
C200  
C200  
C200

**143 4 31** 320 Kg



C150  
C150  
C200  
C200  
C200  
C200  
C200

**143 4 32** 322 Kg

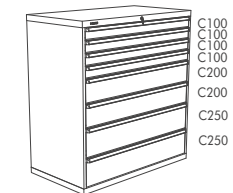

C100  
C100  
C100  
C100  
C200  
C200  
C250

**143 4 33** 345 Kg

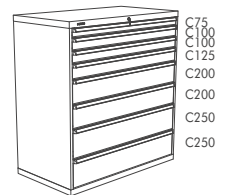

C75  
C100  
C100  
C125  
C200  
C200  
C250  
C250

**143 4 34** 345 Kg

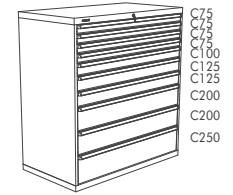

C75  
C75  
C75  
C100  
C125  
C125  
C200  
C200  
C250

**143 4 35** 395 Kg

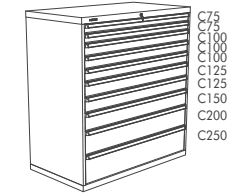

C75  
C100  
C100  
C100  
C125  
C125  
C150  
C200  
C250

**143 4 36** 397 Kg

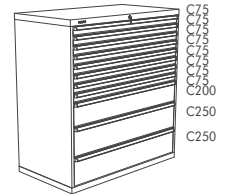

C75  
C75  
C75  
C75  
C75  
C75  
C200  
C250  
C250

**143 4 37** 419 Kg

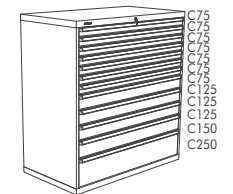

C75  
C75  
C75  
C75  
C75  
C75  
C75  
C125  
C125  
C150  
C250

**143 4 38** 446 Kg

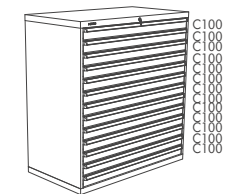

C100  
C100  
C100  
C100  
C100  
C100  
C100  
C100  
C100  
C100

**143 4 39** 472 Kg

**SERIE 122**

Cierre centralizado.  
Verrouillage centralisé.  
Central locking.



Accesorios opcionales  
Accessoires optionnels  
Optional accessories

Sistema antivuelco.  
Système anti-renversement.  
Anti-roll system.

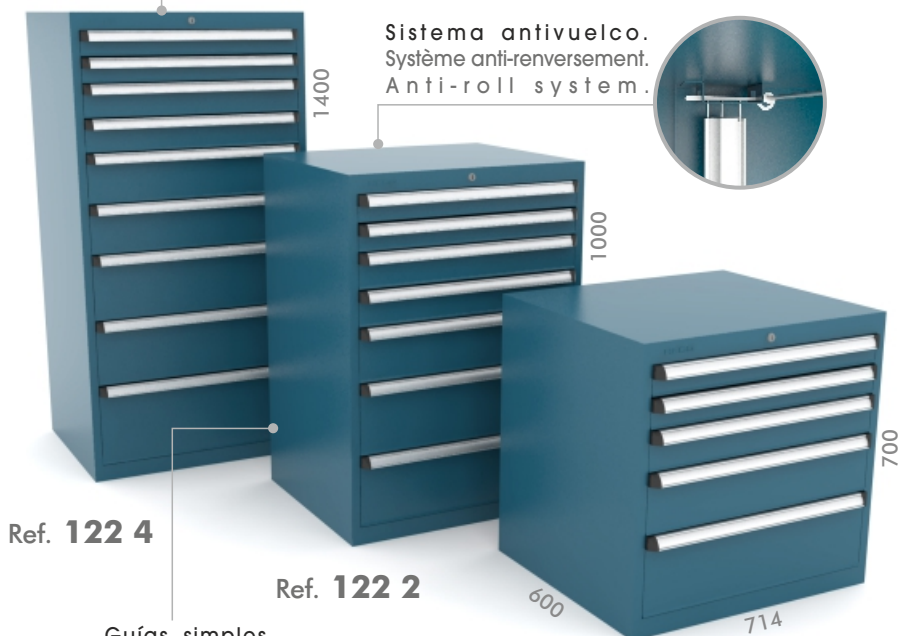

Ref. 122 4

Ref. 122 2

Ref. 122 1

Guías simples.  
Glissières simples.  
Simple slides.

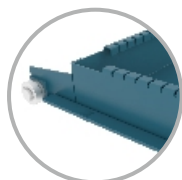

**GS** Apertura 90%.  
Ouverture 90%.  
90% opening.

**BE** Bandeja extraíble con GS.  
Plateau coulissant avec GS.  
Sliding shelf with GS.

Ref. 122 4

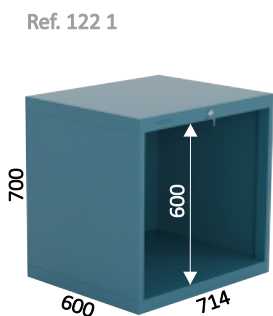

Ref. 122 1

**122** 24.5 Kg  
750 x 650 x 900 mm

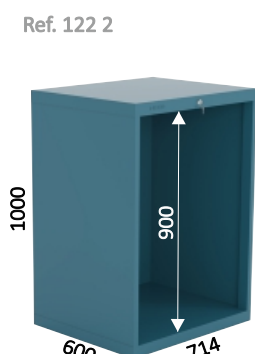

Ref. 122 2

**122** 31 Kg  
750 x 650 x 1200 mm

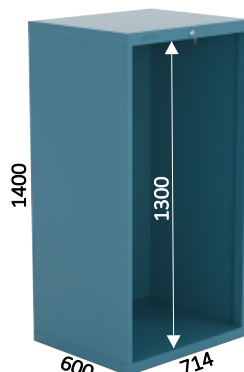

**122** 40 Kg  
750 x 650 x 1600 mm

Ref. 122 Z  
**122** 3,2 Kg

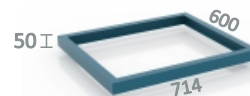

Ref. 122 S M  
**122** 18 Kg

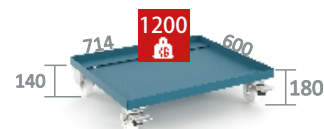

Ref. 122 SE  
**122** 5,9 Kg

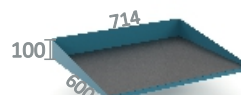

Ref. 115 B ISO 50  
Ref. 115 B HSK 100  
**122** 22 Kg

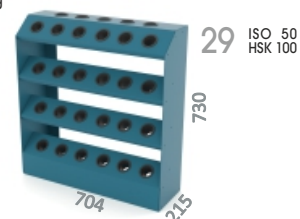

Ref. 115 B ISO 40  
Ref. 115 B HSK 50  
Ref. 115 B HSK 63  
Ref. 115 B HSK 80  
**122** 22 Kg

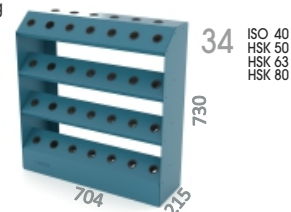

Ref. CE P 1



REF. CE P 1  
REF. CE P 1 TM  
REF. CE P 1 TU

**122** Cierre electrónico  
Verrou électronique  
Electronic locking

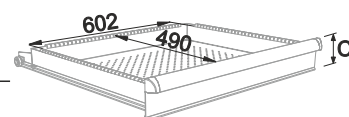

Cajones / Tiroirs / Drawers

SERIE 122	C	●	GS 100	
			●	●
	C=75	●	122 S100 C75	7,5Kg
	C=100	●	122 S100 C100	8Kg
	C=125	●	122 S100 C125	8,5Kg
	C=150	●	122 S100 C150	9Kg
	C=200	●	122 S100 C200	10Kg
	C=250	●	122 S100 C250	11Kg
		■	1.2 mm	

**i** Los cajones no incluyen divisiones.  
Les tiroirs n'incluent pas les séparations.  
Divisions for drawers no included.

**i** Las divisiones se sirven en acero galvanizado.  
Les séparations sont fournies en acier galvanisé.  
The divisions are supplied in galvanised steel.

Ref. **122 1**



C150  
C200  
C250

**122 1 11** 54,5 Kg



C100  
C100  
C200  
C200

**122 1 12** 60,5 Kg



C150  
C150  
C150  
C150

**122 1 13** 60,5 Kg



C75  
C75  
C200  
C250

**122 1 14** 60,5 Kg



C100  
C100  
C150  
C250

**122 1 15** 60,5 Kg



C75  
C75  
C100  
C150  
C200

**122 1 16** 66,5 Kg



C75  
C100  
C125  
C200

**122 1 17** 66,5 Kg

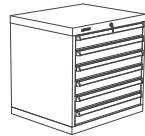

C100  
C100  
C100  
C100  
C100

**122 1 18** 72,5 Kg

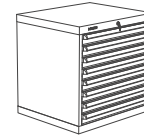

C75  
C75  
C75  
C75  
C75

**122 1 19** 84,5 Kg

Ref. **122 2**

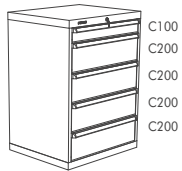

C100  
C200  
C200  
C200  
C200

**122 2 11** 84,5 Kg



C75  
C100  
C125  
C150  
C200  
C250

**122 2 12** 91 Kg



C150  
C150  
C150  
C150  
C150

**122 2 13** 91 Kg

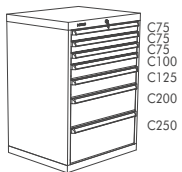

C75  
C75  
C100  
C125  
C200  
C250

**122 2 14** 97 Kg



C75  
C100  
C125  
C125  
C150  
C150

**122 2 15** 103 Kg



C75  
C75  
C100  
C100  
C100  
C125  
C150

**122 2 16** 103 Kg

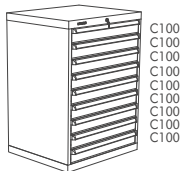

C100  
C100  
C100  
C100  
C100  
C100  
C100

**122 2 17** 109 Kg

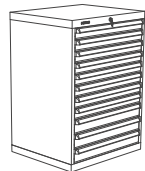

C75  
C75  
C75  
C75  
C75  
C75  
C100  
C100  
C100

**122 2 18** 121 Kg

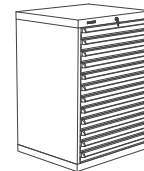

C75  
C75  
C75  
C75  
C75  
C75  
C75

**122 2 19** 127 Kg

Ref. **122 4**

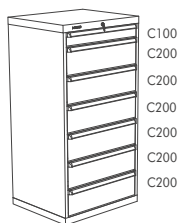

C100  
C200  
C200  
C200  
C200  
C200

**122 4 11** 114 Kg



C150  
C150  
C200  
C200  
C200  
C200

**122 4 12** 114 Kg

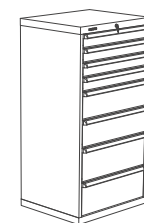

C100  
C100  
C100  
C200  
C250  
C250

**122 4 13** 120 Kg



C75  
C100  
C125  
C200  
C250  
C250

**122 4 14** 121 Kg

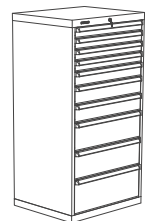

C75  
C75  
C75  
C100  
C125  
C200  
C200  
C250

**122 4 15** 132,5 Kg

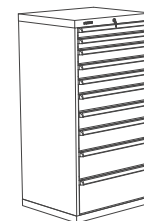

C75  
C75  
C100  
C100  
C125  
C125  
C150  
C200  
C250

**122 4 16** 126 Kg

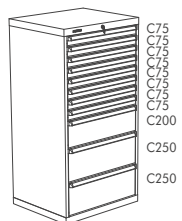

C75  
C75  
C75  
C75  
C75  
C200  
C250  
C250

**122 4 17** 138 Kg

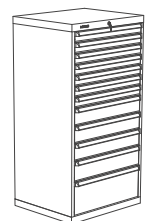

C75  
C75  
C75  
C75  
C75  
C125  
C125  
C150  
C250

**122 4 18** 144 Kg

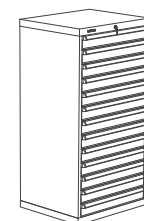

C100  
C100  
C100  
C100  
C100  
C100  
C100  
C100

**122 4 19** 150 Kg

**SERIE 123**

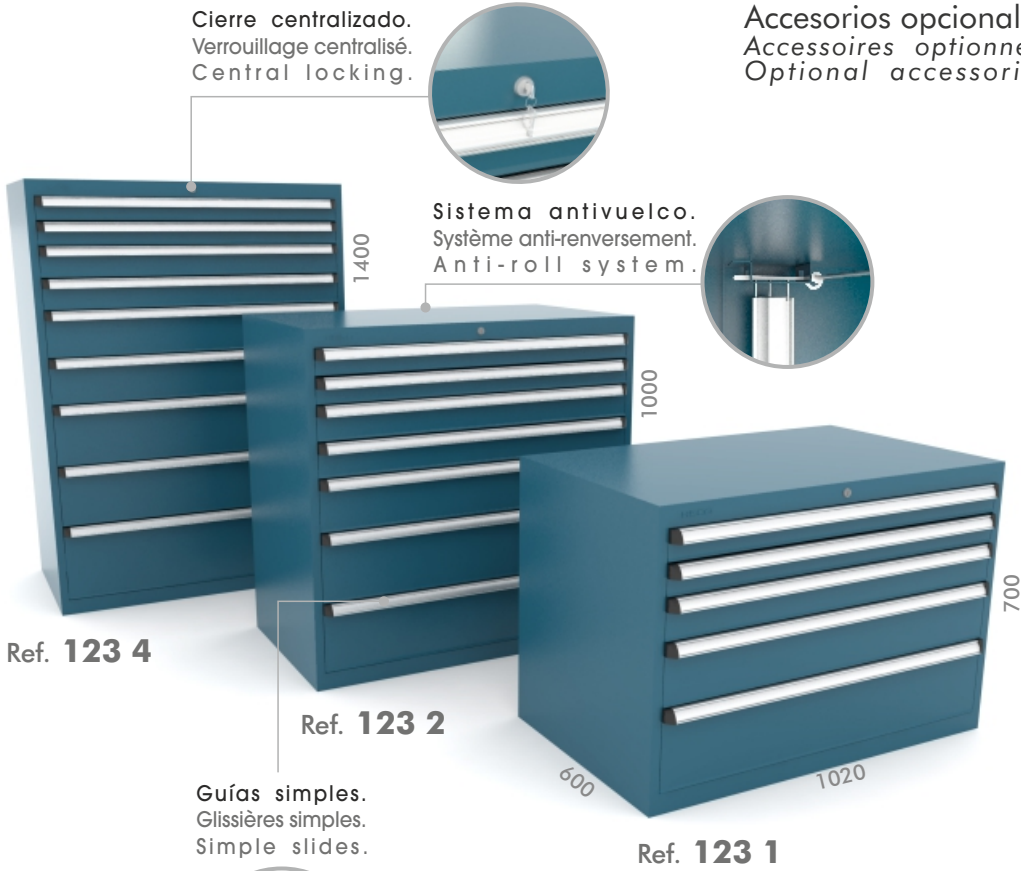

**Accesorios opcionales**  
Accessoires optionnels  
Optional accessories

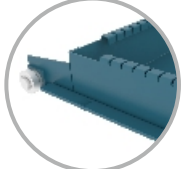
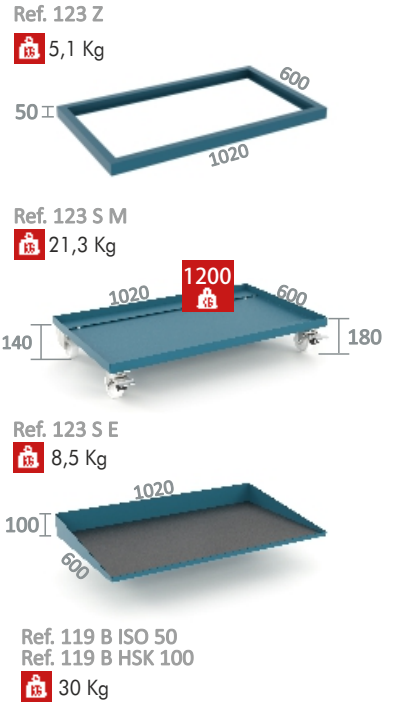

**BE** Bandeja extraíble con GS.  
Plateau coulissant avec GS.  
Removable tray with GS.

**GS** Apertura 90%.  
Ouverture 90%.  
90% opening.

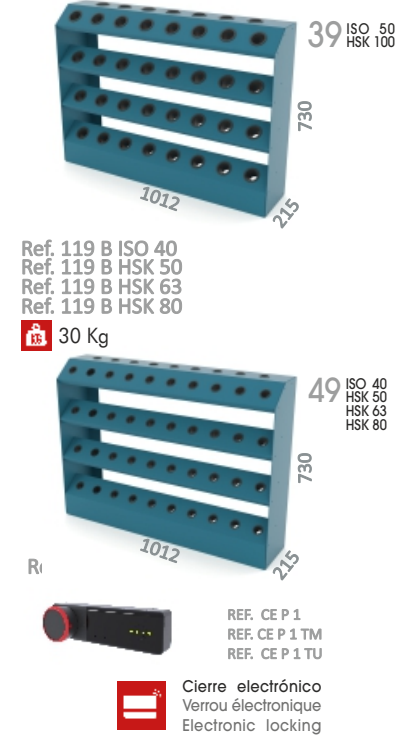
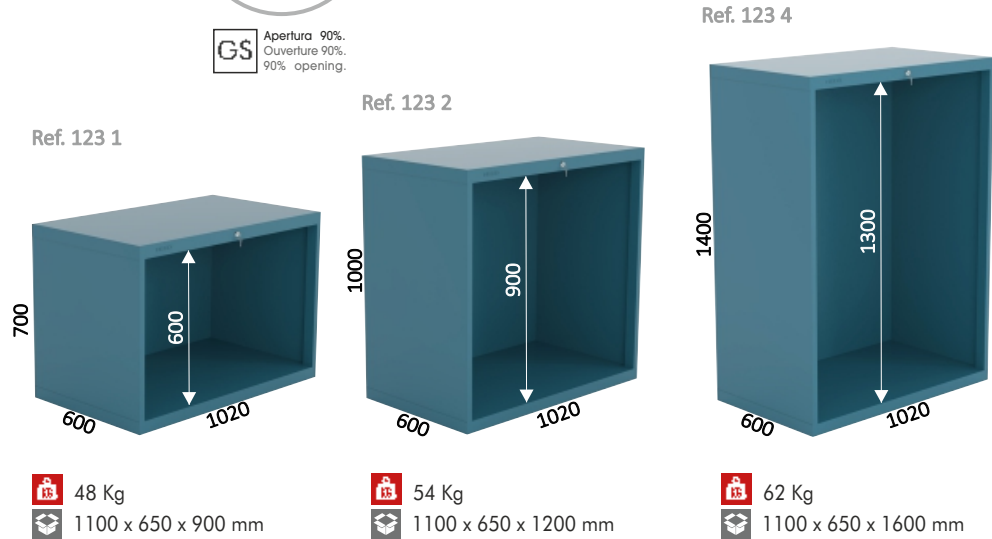

**Cajones / Tiroirs / Drawers**

SERIE 123	C=75	●	GS 100	
			123 S100 C75	9,5Kg
	C=100	●	123 S100 C100	10,5Kg
	C=125	●	123 S100 C125	11Kg
	C=150	●	123 S100 C150	11,5Kg
	C=200	●	123 S100 C200	13Kg
	C=250	●	123 S100 C250	14,5Kg
			<b>1.2 mm</b>	

**i** Los cajones no incluyen divisiones.  
Les tiroirs n'inclus pas les séparations.  
Divisions for drawers no included.

**i** Las divisiones se sirven en acero galvanizado.  
Les séparations sont fournies en acier galvanisé.  
The divisions are supplied in galvanised steel.

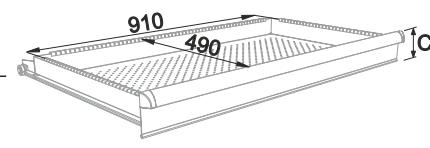

Ref. **123 1**

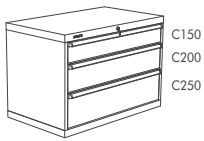

C150  
C200  
C250

**123 1 11** 87 Kg

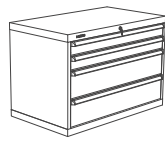

C100  
C100  
C200  
C200

**123 1 12** 95 Kg



C150  
C150  
C150  
C150

**123 1 13** 94 Kg

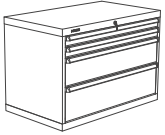

C75  
C75  
C200  
C250

**123 1 14** 94,5 Kg



C100  
C100  
C150  
C250

**123 1 15** 95 Kg

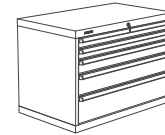

C75  
C75  
C100  
C150  
C200

**123 1 16** 102 Kg

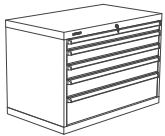

C75  
C100  
C100  
C125  
C200

**123 1 17** 102,5 Kg

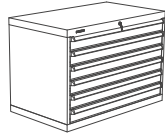

C100  
C100  
C100  
C100  
C100  
C100  
C100

**123 1 18** 111 Kg

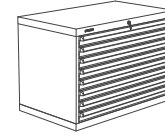

C75  
C75  
C75  
C75  
C75  
C75  
C75  
C75

**123 1 19** 124 Kg

Ref. **123 2**



C100  
C200  
C200  
C200  
C200

**123 2 11** 105,5 Kg



C75  
C100  
C125  
C150  
C200  
C250

**123 2 12** 113 Kg



C150  
C150  
C150  
C150  
C150  
C150

**123 2 13** 112 Kg



C75  
C75  
C75  
C100  
C125  
C200  
C250

**123 2 14** 120,5 Kg



C75  
C100  
C100  
C125  
C150  
C150  
C150

**123 2 15** 128 Kg

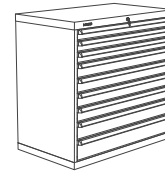

C75  
C75  
C75  
C100  
C100  
C100  
C125  
C150  
C150

**123 2 16** 136 Kg



C100  
C100  
C100  
C100  
C100  
C100  
C100  
C100  
C100  
C100

**123 2 17** 137,5 Kg

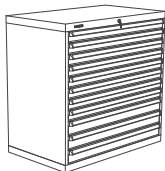

C75  
C75  
C75  
C75  
C75  
C75  
C75  
C75  
C100  
C100  
C100

**123 2 18** 150,5 Kg

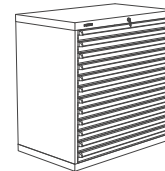

C75  
C75  
C75  
C75  
C75  
C75  
C75  
C75  
C75  
C75

**123 2 19** 157 Kg

Ref. **123 4**



C100  
C200  
C200  
C200  
C200  
C200  
C200  
C200

**123 4 11** 142,5 Kg



C150  
C150  
C200  
C200  
C200  
C200  
C200

**123 4 12** 142 Kg

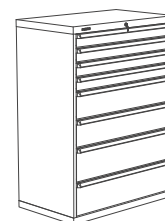

C100  
C100  
C100  
C100  
C200  
C200  
C250  
C250

**123 4 13** 151 Kg

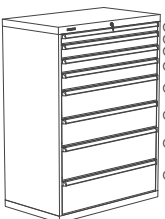

C75  
C100  
C100  
C125  
C200  
C200  
C250  
C250

**123 4 14** 150,5 Kg

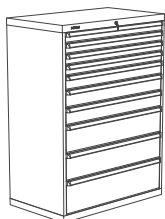

C75  
C75  
C75  
C75  
C100  
C125  
C125  
C200  
C200  
C250

**123 4 15** 165 Kg

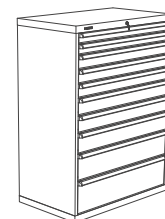

C75  
C75  
C100  
C100  
C100  
C125  
C125  
C150  
C200  
C250

**123 4 16** 155 Kg

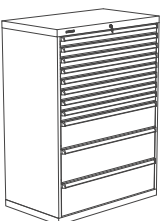

C75  
C75  
C75  
C75  
C75  
C75  
C200  
C250  
C250

**123 4 17** 172 Kg

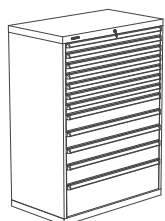

C75  
C75  
C75  
C75  
C75  
C75  
C125  
C125  
C125  
C150  
C250

**123 4 18** 179,5 Kg

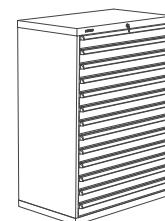

C100  
C100  
C100  
C100  
C100  
C100  
C100  
C100  
C100  
C100  
C100

**123 4 19** 177,5 Kg

**SERIE 135**

Accesorios opcionales  
Accessoires optionnels  
Optional accessories

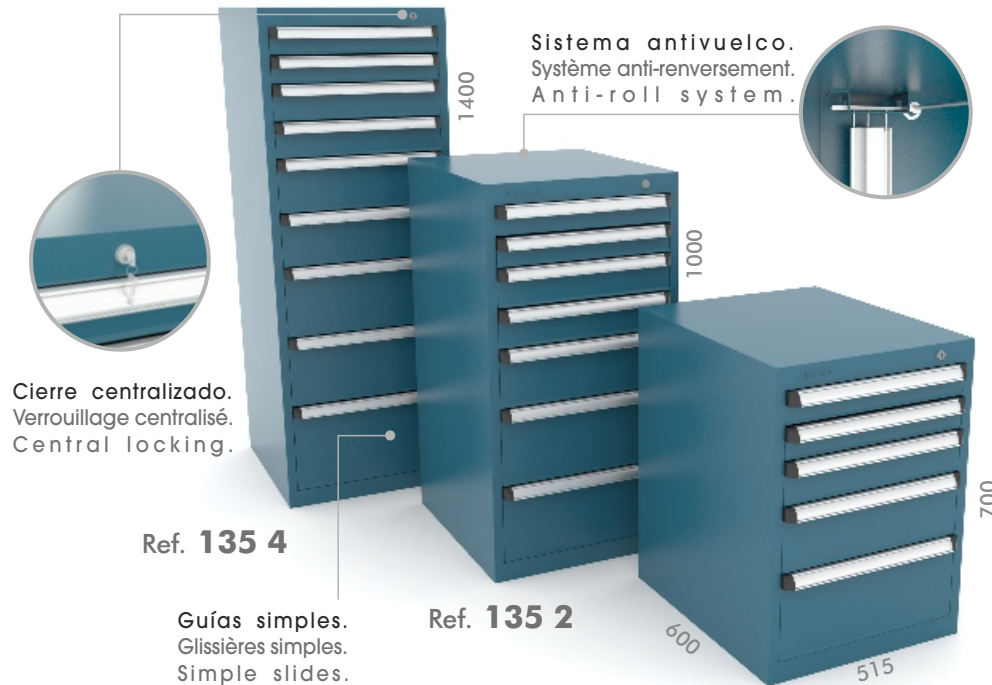

**BE** Bandeja extraíble con GS.  
Plateau coulissant avec GS.  
Removable tray with GS.

**GS** Apertura 90%.  
Ouverture 90%.  
90% opening.

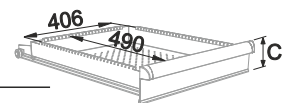
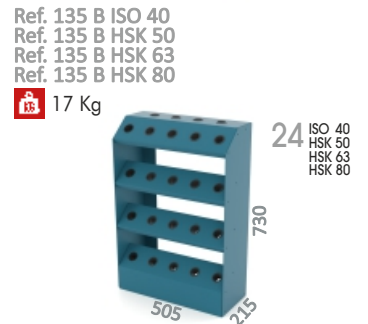
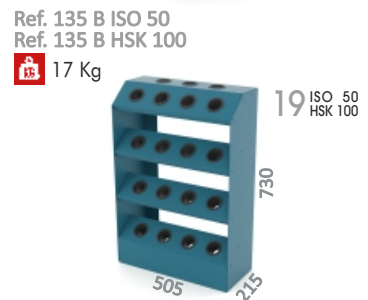
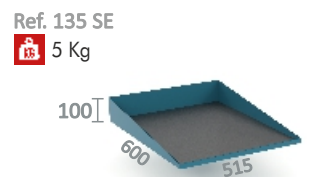
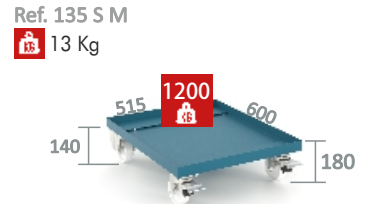
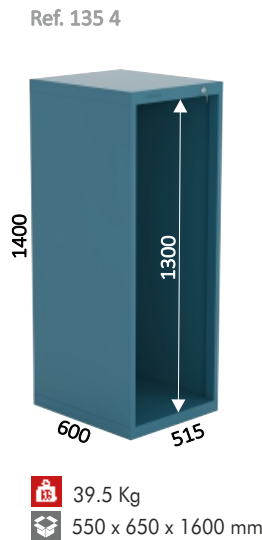
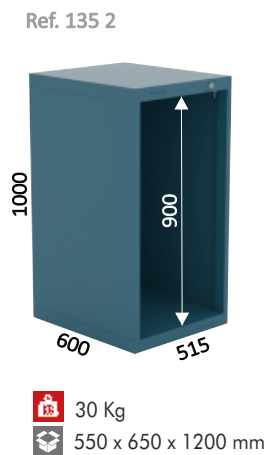
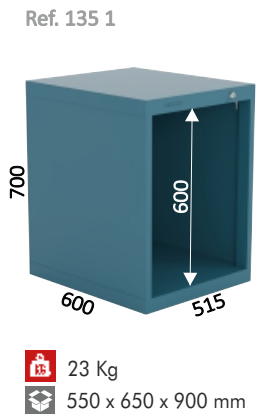

Cajones / Tiroirs / Drawers

SERIE 135	C=75	●	135 S100 C75	6,5Kg	GS 100	●	135 S100 C100	7Kg	GS 100	●	135 S100 C125	7,5Kg	GS 100	●	135 S100 C150	8Kg	GS 100	●	135 S100 C200	8,5Kg	GS 100	●	135 S100 C250	9,5Kg	GS 100	●	135 S100 C300	10,5Kg	GS 100	●	135 S100 ISO 40	135 S100 HSK 50	135 S100 HSK 63	135 S100 HSK 80	135 S100 ISO 50	●	135 S100 HSK 100	10,5Kg
												12 PORTACONOS 12 PORTE-CÔNES 12 TOOL HOLDER																										

Los cajones no incluyen divisiones.  
Les tiroirs n'incluent pas les séparations.  
Divisions for drawers no included.

Los divisiones se sirven en acero galvanizado.  
Les séparations sont fournies en acier galvanisé.  
The divisions are supplied in galvanised steel.

Ref. **135 1**

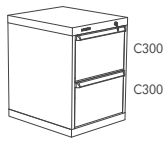

**135 1 11** 44 Kg



**135 1 12** 54,5 Kg



**135 1 13** 55 Kg

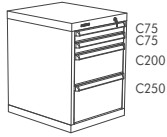

**135 1 14** 54 Kg



**135 1 15** 54,5 Kg

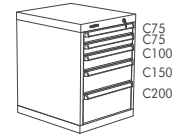

**135 1 16** 59,5 Kg



**135 1 17** 59,5 Kg



**135 1 18** 65 Kg

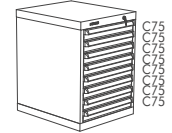

**135 1 19** 75 Kg

Ref. **135 2**



**135 2 11** 71 Kg



**135 2 12** 77 Kg



**135 2 13** 78 Kg



**135 2 14** 82 Kg



**135 2 15** 88 Kg

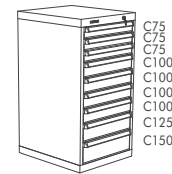

**135 2 16** 93 Kg

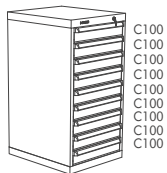

**135 2 17** 93 Kg

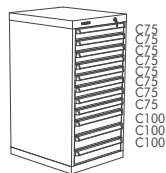

**135 2 18** 103 Kg

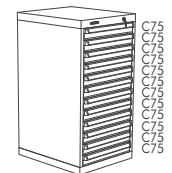

**135 2 19** 108 Kg

Ref. **135 4**

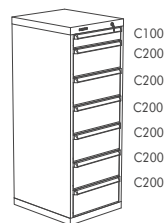

**135 4 11** 97,5 Kg

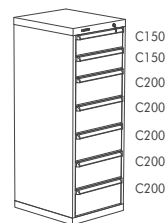

**135 4 12** 98 Kg

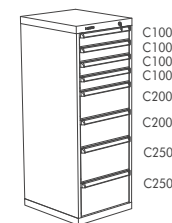

**135 4 13** 103,5 Kg

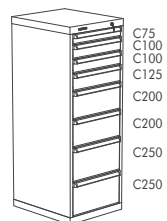

**135 4 14** 103,5 Kg

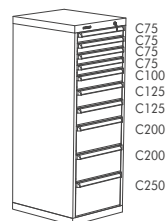

**135 4 15** 114 Kg

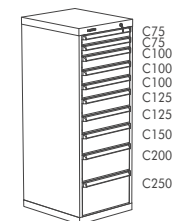

**135 4 16** 114,5 Kg

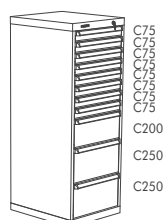

**135 4 17** 119 Kg

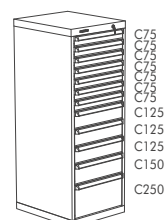

**135 4 18** 125 Kg

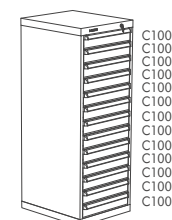

**135 4 19** 130,5 Kg

**SERIE 136 2**

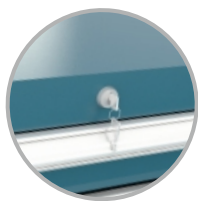

Cierre centralizado.  
Verrouillage centralisé.  
Central locking.

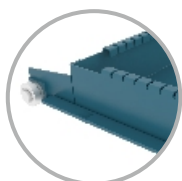

Guías simples.  
Glissières simples.  
Simple slides.

**GS** Apertura 90%.  
Ouverture 90%.  
90% opening.

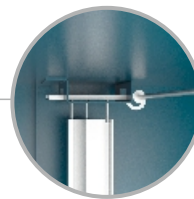

Sistema antivuelco.  
Système anti-renversement.  
Anti-roll system.



Ref. **136 2 1**



Ref. **136 2 2**

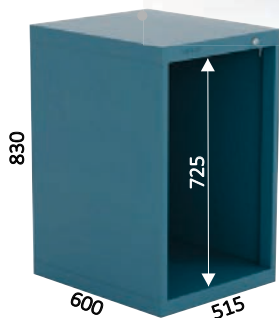

Gama de productos  
Gamme de produits  
Product range

**SERIE 136 2**

- 25 Kg
- 550 x 650 x 900 mm



Ref. **136 2 1**

62 Kg



Ref. **136 2 2**

67 Kg

Accesorios opcionales  
Accessoires optionnels  
Optional accessories

Ref. CE P 1



REF. CE P 1  
REF. CE P 1 TM  
REF. CE P 1 TU

Cierre electrónico  
Verrou électronique  
Electronic locking

Cajones / Tiroirs / Drawers

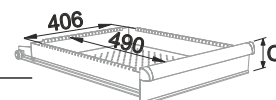

SERIE 136 2	GS  136 2 1			GS  136 2 2			GS  12 PORTACONOS 12 PORTE-CÔNES 12 TOOL HOLDER		
	C=50	C=75	C=100	C=125	C=150	C=200	C=250	C=300	
	●	●	●	● (x2)	●	●	●	●	135 S100 C75
		●	●	●	●	●	●	●	135 S100 C100
			●	●	●	●	●	●	135 S100 C125
				●	●	●	●	●	135 S100 C150
					●	●	●	●	135 S100 C200
						●	●	●	135 S100 C300
								●	135 S100 ISO 50
								●	135 S100 HSK 63
								●	135 S100 HSK 80
								●	135 S100 HSK 100
									10,5Kg
									1 mm

Los cajones no incluyen divisiones.  
Les tiroirs n'incluent pas les séparations.  
Divisions for drawers no included.

Las divisiones se sirven en acero galvanizado.  
Les séparations sont fournies en acier galvanisé.  
The divisions are supplied in galvanised steel.

SERIE 106

Armario con cajones de reducidas dimensiones ( 5 o 3 cajones).  
Armoire avec tiroirs de dimension réduites ( 5 ou 3 tiroirs).  
Cabinet with drawers of reduced dimension (5 or 3 drawers).

Ref. 106 4 1

17,21 Kg

Ref. 106 4 2

19,26 Kg

Ref. 106 4 3

15,90 Kg



Ref. 106 4 4

14,83 Kg

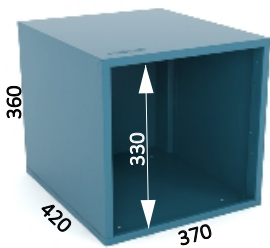

Ref. 106

6,39 Kg

400 x 450 x 400 mm

Cajones / Tiroirs / Drawers

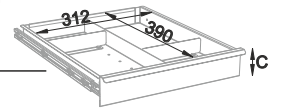
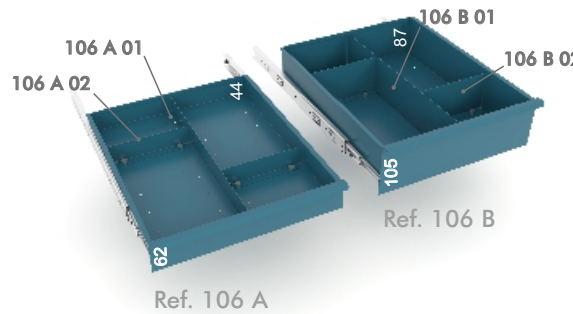

106 A	C=62	4,26 Kg
106 B	C=105	4,42 Kg

GT	15
●	(x5)
●	(x3)
⊕	0.8 mm



Los divisiones se sirven en acero galvanizado.  
Les séparations sont fournies en acier galvanisé.  
The divisions are supplied in galvanised steel.

Gama de productos / Gamme de produits / Product range

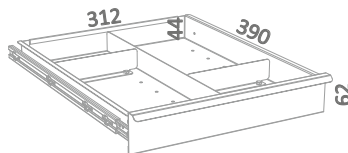
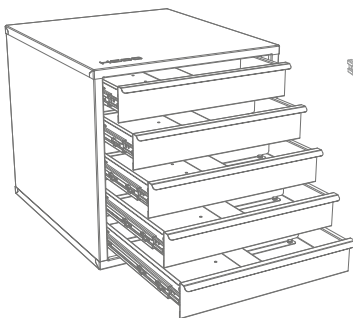

Ref. 106 4 1

17,21 Kg

CAJONES  
TIROIRS  
DRAWERS 106 A x5  
DIVISIONES  
SÉPARATIONS  
DIVISIONS 1u. 106 A 01  
2u. 106 A 02

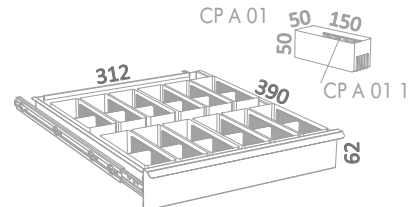
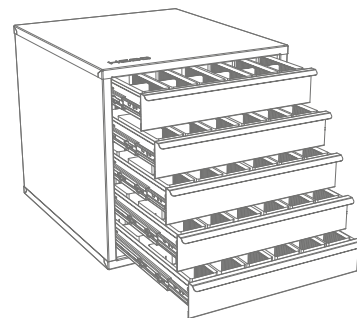

Ref. 106 4 2

19,26 Kg

CAJONES  
TIROIRS  
DRAWERS 106 A x5  
CUBETAS  
BOÎTES  
TRAYS 12u. CPA 01  
12u. CPA 01 1

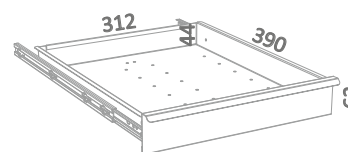
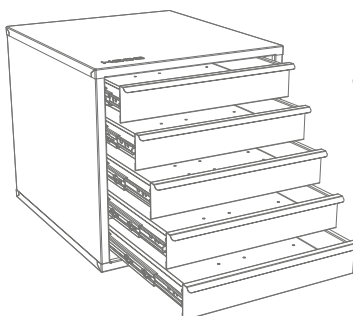

Ref. 106 4 3

15,90 Kg

CAJONES  
TIROIRS  
DRAWERS 106 A x5

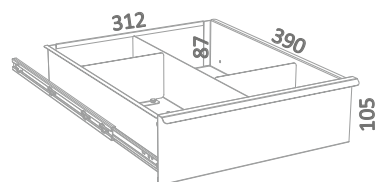
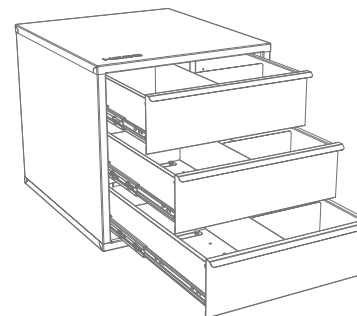

Ref. 106 4 4

14,83 Kg

CAJONES  
TIROIRS  
DRAWERS 106 B x3  
DIVISIONES  
SÉPARATIONS  
DIVISIONS 1u. 106 B 01  
2u. 106 B 02

**SERIE 400**

 oficinas  
bureaux  
offices

 Armarios archivadores.  
Armoire à classeurs.  
Closets filing cabinets.

**Ref. 4400**

**Ref. 4300**

 Cierre centralizado.  
Verrouillage centralisé.  
Central locking.

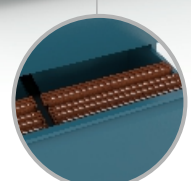
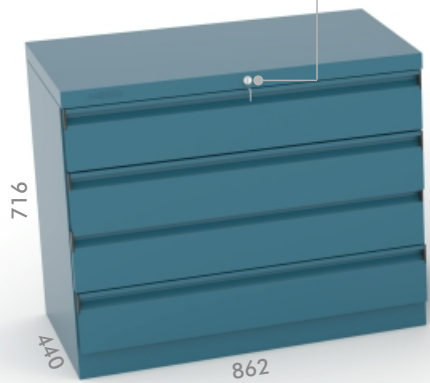
**Ref. 4200**

 Bloqueo cajones y guías.  
Verrouillage des tiroirs et glissières.  
Locking drawers and slides.

 Consultar plazo de entrega.  
Consulter le délai de livraison.  
Check delivery time.

 Soporte para archivadores. Incluidos en serie 400 F.  
Support pour classeurs. Inclus dans série 400 F.  
Folding - holder. Included at serie 400 F.

**Accesorios opcionales**  
*Accessoires optionnels*  
*Optional accessories*
**Ref. CE P 1**

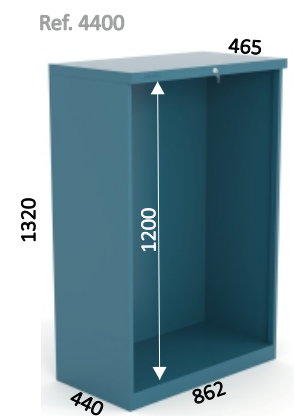
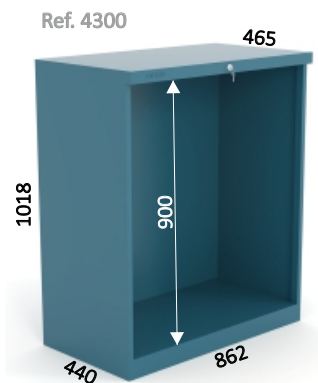
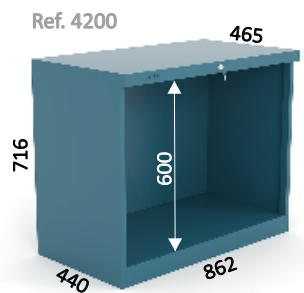
 REF. CE P 1  
REF. CE P 1 TM  
REF. CE P 1 TU

 Cierre electrónico  
Verrou électronique  
Electronic locking

 13,5 Kg  
 900 x 500 x 800 mm

 15,5 Kg  
 900 x 500 x 1100 mm

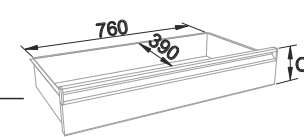
 17,8 Kg  
 900 x 500 x 1300 mm

**Cajones / Tiroirs / Drawers**

400 C	C=150	6,4 Kg	●
400 F	C=300	11 Kg	●
		0.8 mm	

 Los cajones no incluyen divisiones.  
Les tiroirs n'incluent pas les séparations.  
Divisions for drawers no included.

 Las divisiones se sirven en acero galvanizado.  
Les séparations sont fournies en acier galvanisé.  
The divisions are supplied in galvanised steel.

 Existen composiciones estándares de cajones, ver en catálogo web.  
Des compositions de tiroirs standard sont disponibles, voir le catalogue en ligne.  
Standard drawer compositions are available, see web catalogue.

Ref. **4200**

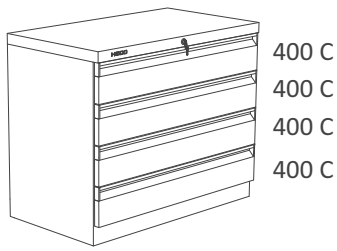

400 C  
400 C  
400 C  
400 C

Ref. **4204**

41,8 Kg

H 716 mm

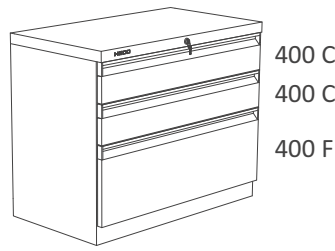

400 C  
400 C  
400 F

Ref. **4212**

38,5Kg

H 716 mm

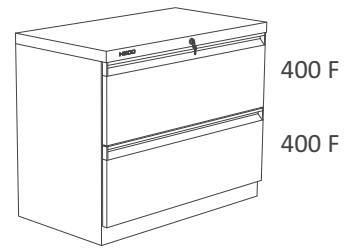

400 F  
400 F

Ref. **4220**

35,5 Kg

H 716 mm

Ref. **4300**

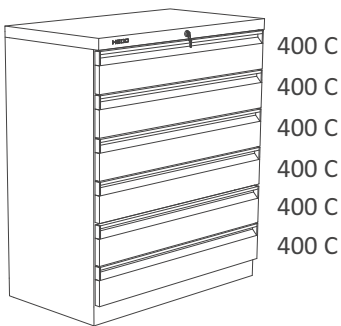

400 C  
400 C  
400 C  
400 C  
400 C  
400 C

Ref. **4306**

58,2 Kg

H 1018 mm

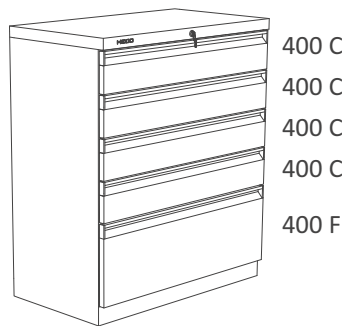

400 C  
400 C  
400 C  
400 C  
400 F

Ref. **4314**

55 Kg

H 1018 mm

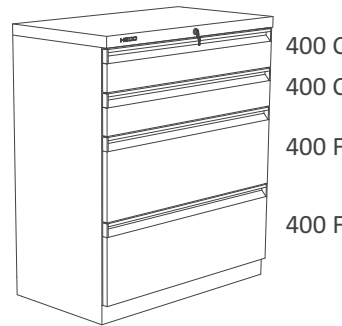

400 C  
400 C  
400 F  
400 F

Ref. **4322**

52 Kg

H 1018 mm

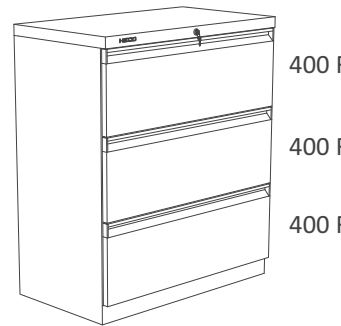

400 F  
400 F  
400 F

Ref. **4330**

48,5 Kg

H 1018 mm

Ref. **4400**

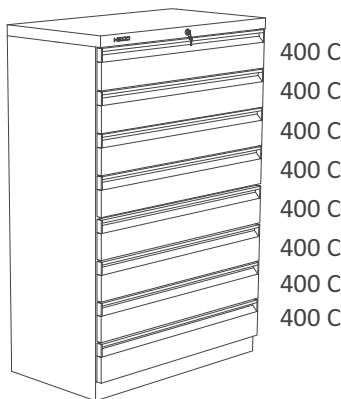

400 C  
400 C  
400 C  
400 C  
400 C  
400 C  
400 C  
400 C

Ref. **4408**

74,6 Kg

H 1320 mm

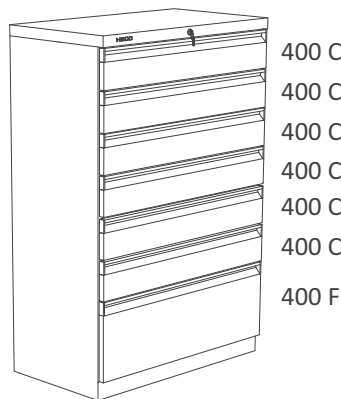

400 C  
400 C  
400 C  
400 C  
400 C  
400 C  
400 F

Ref. **4416**

71,5 Kg

H 1320 mm

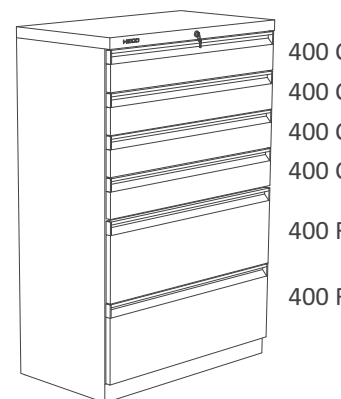

400 C  
400 C  
400 C  
400 C  
400 F  
400 F

Ref. **4424**

68,2 Kg

H 1320 mm

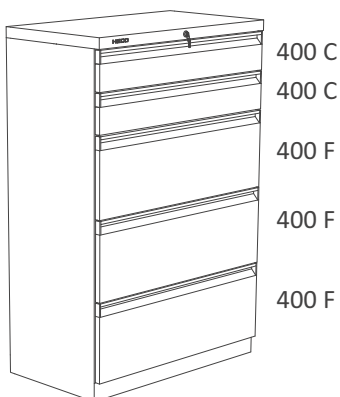

400 C  
400 C  
400 F  
400 F  
400 F

Ref. **4432**

65 Kg

H 1320 mm

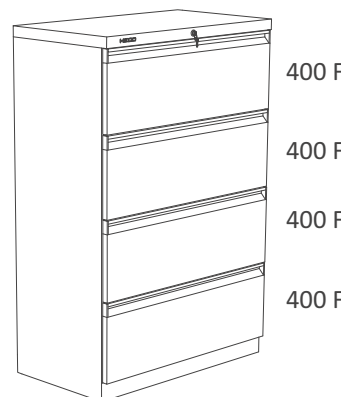

400 F  
400 F  
400 F  
400 F

Ref. **4440**

61,8 Kg

H 1320 mm

## SERIE 400

Divisiones estandar para armarios de oficinas.  
Séparateurs standards pour armoires de bureaux.  
Standard divisions compositions for offices cabinets.

Ref. **400 43 C**  
**400 C** (Hf 150mm)  
1x 400 RF C  
3x 400 C 208  
5x 400 RL C  
1x 400 RA C

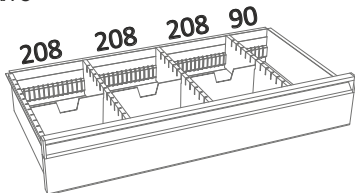

Ref. **400 44 C**  
**400 C** (Hf 150mm)  
1x 400 RF C  
3x 400 C 222  
4x 400 RL C  
1x 400 RA C

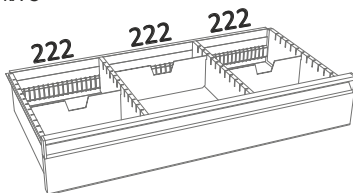

Ref. **400 45 C**  
**400 C** (Hf 150mm)  
1x 400 RF C  
4x 400 C 152  
7x 400 RL C  
1x 400 RA C

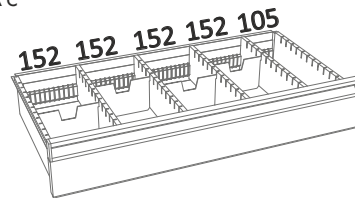

Ref. **400 33 F**  
**400 F** (Hf 300mm)  
1x 400 RF F  
2x 400 F 363  
2x 400 RL F  
1x 400 RA F

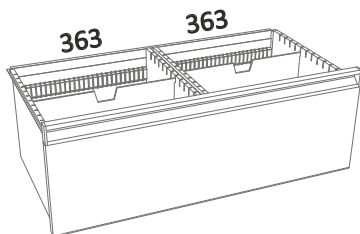

Ref. **400 35 F**  
**400 F** (Hf 300mm)  
1x 400 RF F  
2x 400 F 306  
2x 400 RL F  
1x 400 RA F

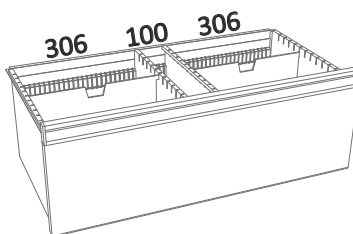

Ref. **400 40 F**  
**400 F** (Hf 300mm)  
1x 400 RF F  
2x 400 F 152  
7x 400 RL F  
1x 400 RA F

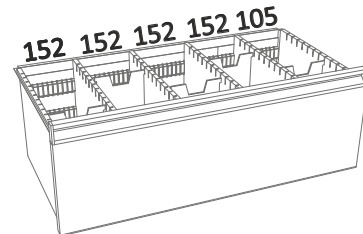

Accesorios para armarios de oficinas.  
Accessoires pour armoires de bureaux.  
Accessories for offices cabinets.

### Longitudinales / Longitudinales / Longitudinals

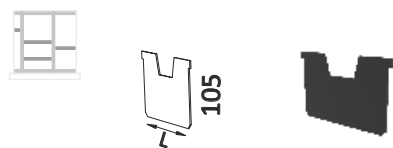

L 82 / 110 / 138 / 152 / 208 / 222

Ref. **400 C**  
e 1.5 mm

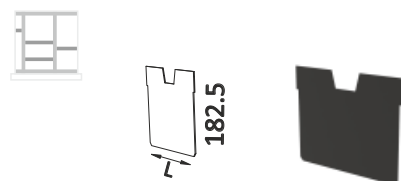

L 110 / 152 / 222 / 250 / 306 / 348 / 363

Ref. **400 F**  
e 1.5 mm



Ref. **400 RL C**  
e 1 mm

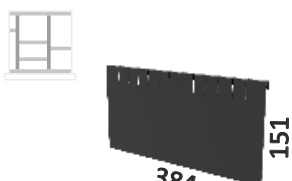

Ref. **400 RL F**  
e 1 mm

### Ranuradas / Rainures / Slotted

Ref. **400 RA/RF C**  
e 1+0.6 mm

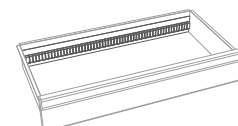
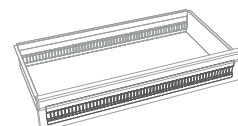

Ref. **400 RA/RF F**  
e 1+0.6 mm

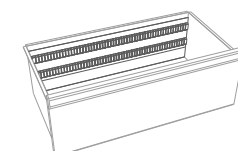
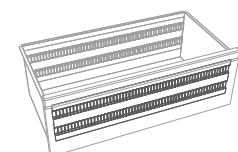
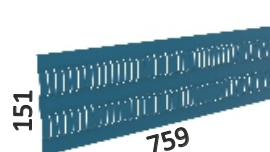

Es indispensable coger las divisiones RA y RF según cajón C o F.  
Il est essentiel de prendre les divisions RA et RF en fonction du tiroir C ou F.  
It is essential to take the RA and RF divisions according to drawer C or F.

**SERIE CP A**

CUBETAS EN PS.  
 BOITES EN PS.  
 PS TRAYS.

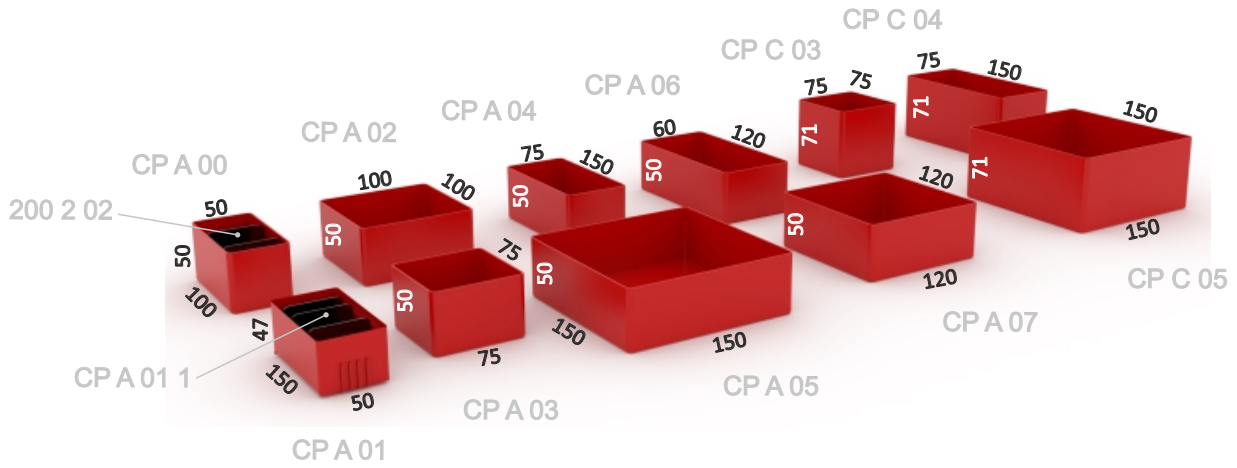

CLASIFICADORES  
 TRIEUSES  
 SORTERS

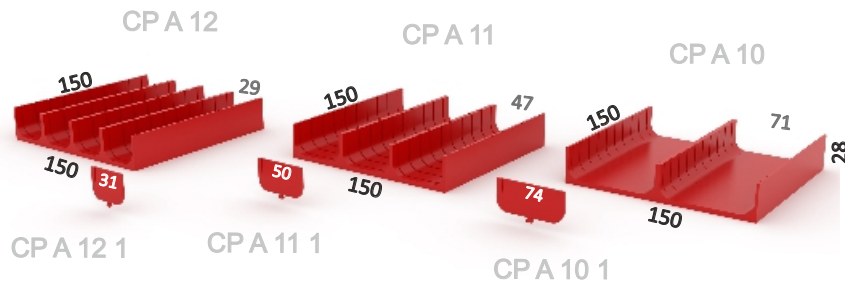

**SERIE MP**

CLASIFICADORES ABS  
 TRIEUSES ABS  
 ABS SORTERS

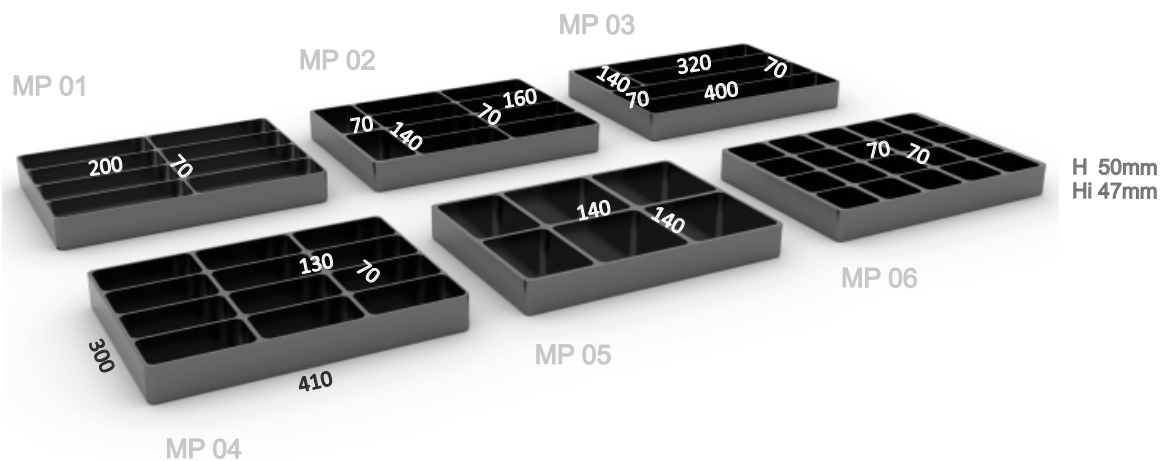

CONSULTAR DISPONIBILIDAD Hasta fin de existencias  
 VÉRIFIER LA DISPONIBILITÉ Jusqu'à épuisement du stock  
 CHECK AVAILABILITY Until end of stock

**SERIE 115-126-127**

Divisiones para cajones según altura frontal.  
Séparateurs des tiroirs selon hauteur de frontal.  
Drawer divisions according to front height.

Ref. **115 Hf D1**  
Hf 050-075-100-125-150-200-250

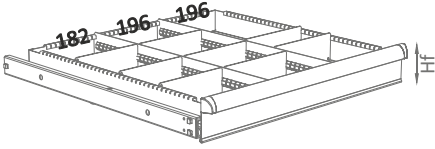

Ref. **115 Hf D2**  
Hf 050-075-100-125-150-200-250

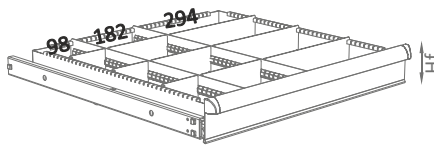

Ref. **115 Hf D3**  
Hf 050-075-100-125-150-200-250

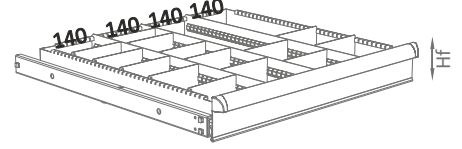

Ref. **115 Hf D4**  
Hf 050-075-100-125-150-200-250

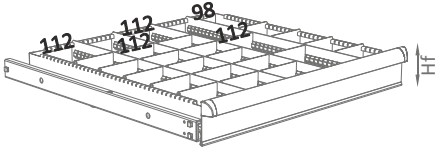

Ref. **115 Hf D5**  
Hf 050-075-100-125-150-200-250

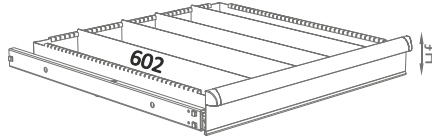

Ref. **115 Hf D6**  
Hf 050-075-100-125-150-200-250

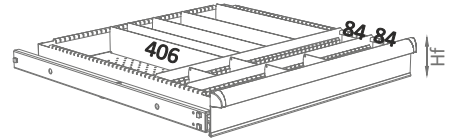

**SERIE 115-126-127**

Cubetas para cajones según altura frontal, sólo cajón 75 y 100.  
Boîtes des tiroirs selon hauteur de frontal, tiroir 75 et 100 seulement.  
Drawer trays according to front height, drawer 75 and 100 only.

Ref. **115 MP 01-02**  
Hf 075-100

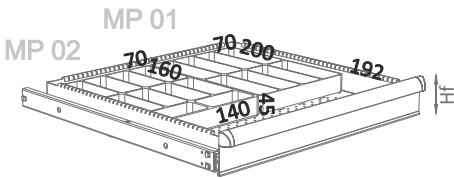

Ref. **115 MP 03-04**  
Hf 075-100

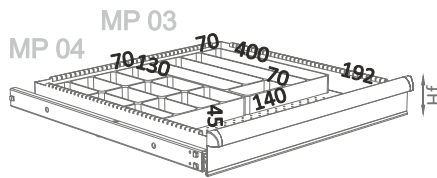

Ref. **115 MP 05-06**  
Hf 075-100

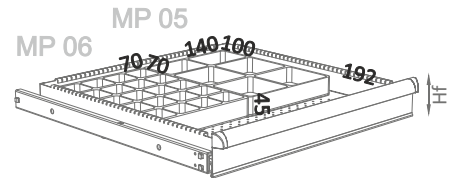

**SERIE 115-126-127**

Cubetas para cajones según altura frontal.  
Boîtes des tiroirs selon hauteur de frontal.  
Drawer trays according to front height.

Ref. **115 075 C1**  
Hf 075-100  
48x CPA 01  
48x CPA 01 1

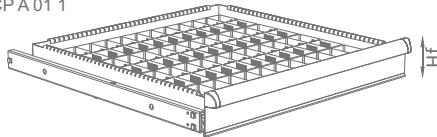

Ref. **115 075 C2**  
Hf 075-100  
24x CPA 00  
24x 200 2 02  
24x CPA 02

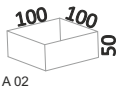
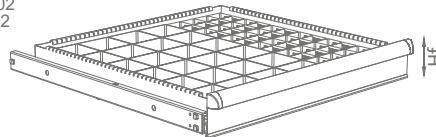

Ref. **115 075 C3**  
Hf 075-100  
16x CPA 04  
8x CPA 05

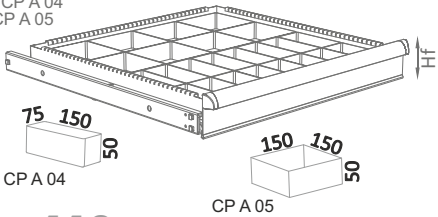

Ref. **115 075 C4**  
Hf 075-100  
4x CPA 10  
4x CPA 11  
8x CPA 12

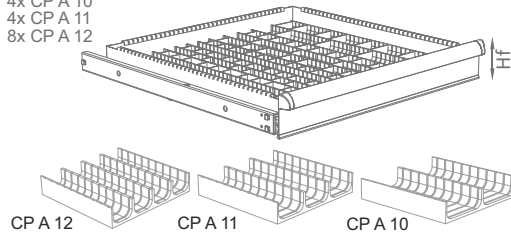

Ref. **115 125 C1**  
Hf 125-150  
4x CP C 05  
24x CP C 04

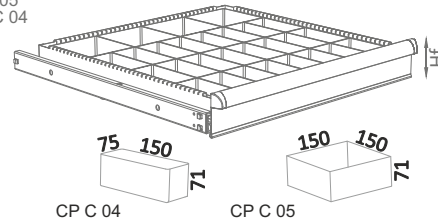

**SERIE 119**

Divisiones para cajones según altura frontal.  
Séparateurs des tiroirs selon hauteur de frontal.  
Drawer divisions according to front height.

Ref. **119 Hf D3**  
Hf 050-075-100-125-150-200-250

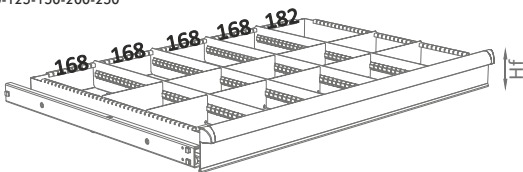

Ref. **119 Hf D4**  
Hf 050-075-100-125-150-200-250

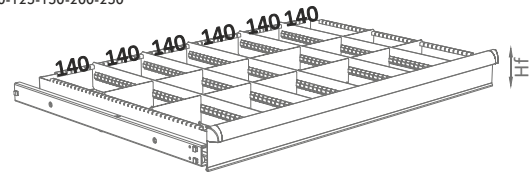

Ref. **119 Hf D5**  
Hf 050-075-100-125-150-200-250

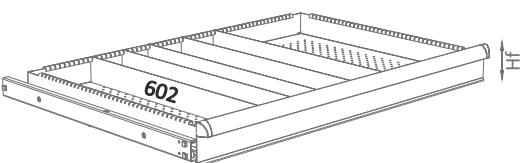

Ref. **119 Hf D6**  
Hf 050-075-100-125-150-200-250

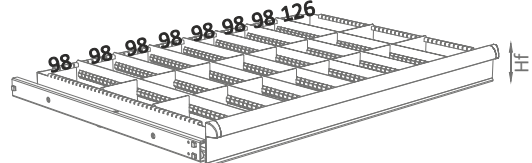

SERIE 119

Cubetas para cajones según altura frontal, sólo cajón 75 y 100.  
 Boîtes des tiroirs selon hauteur de frontal, tiroir 75 et 100 seulement.  
 Drawer trays according to front height, drawer 75 and 100 only.

Ref. 119 MP 01-02-03  
 Hf 075-100

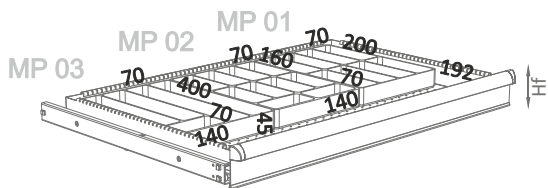

Ref. 119 MP 04-05-06  
 Hf 075-100

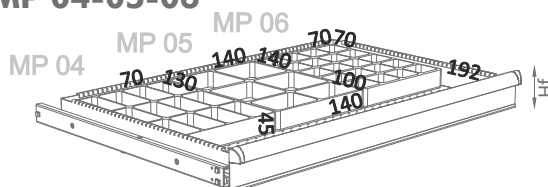

SERIE 122

Divisiones para cajones según altura frontal.  
 Séparateurs des tiroirs selon hauteur de frontal.  
 Drawer divisions according to front height.

Ref. 122 Hf D1  
 Hf 075-100-125-150-200-250

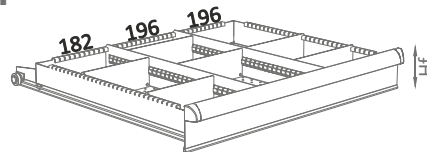

Ref. 122 Hf D2  
 Hf 075-100-125-150-200-250

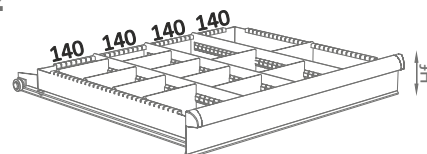

SERIE 123

Divisiones para cajones según altura frontal.  
 Séparateurs des tiroirs selon hauteur de frontal.  
 Drawer divisions according to front height.

Ref. 123 Hf D1  
 Hf 075-100-125-150-200-250

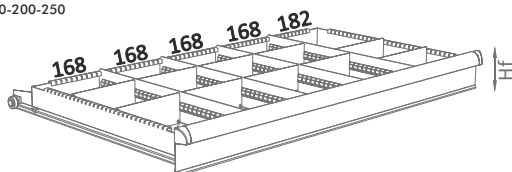

Ref. 123 Hf D2  
 Hf 075-100-125-150-200-250

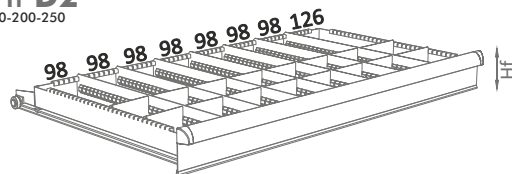

SERIE 135

Divisiones para cajones según altura frontal.  
 Séparateurs des tiroirs selon hauteur de frontal.  
 Drawer divisions according to front height.

Ref. 135 Hf D1  
 Hf 075-100-125-150-200-250

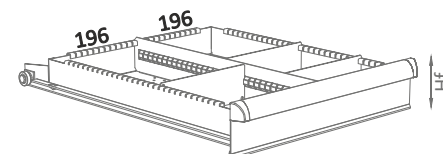

Ref. 135 Hf D2  
 Hf 075-100-125-150-200-250

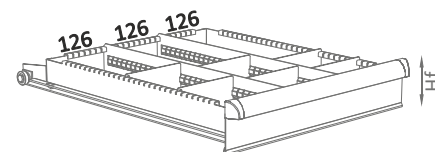

Divisiones para cajones según altura frontal.  
 Séparateurs des tiroirs selon hauteur de frontal.  
 Drawer divisions according to front height.

Ref. 143 Hf D3  
 Hf 075-100-125-150-200-250

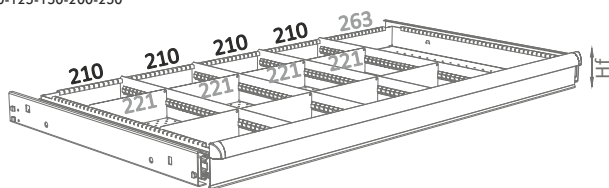

Ref. 143 Hf D5  
 Hf 075-100-125-150-200-250

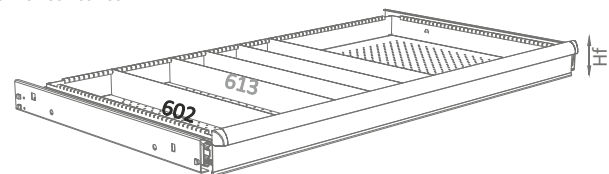

SERIE 143

Ref. 143 Hf D4  
 Hf 075-100-125-150-200-250

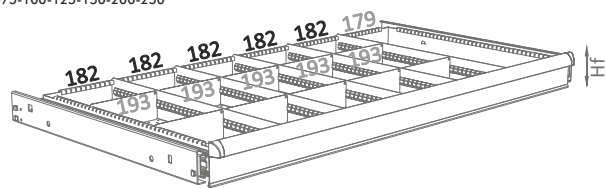

Ref. 143 Hf D6  
 Hf 075-100-125-150-200-250

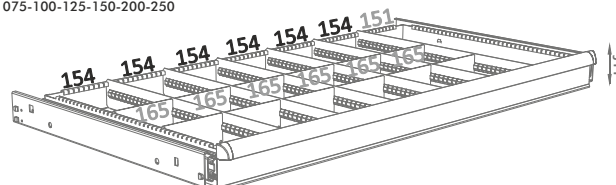

Cubetas para cajones según altura frontal, sólo cajón 75 y 100.  
 Boîtes des tiroirs selon hauteur de frontal, tiroir 75 et 100 seulement.  
 Drawer trays according to front height, drawer 75 and 100 only.

Ref. 143 MP 01-02-03  
 Hf 075-100

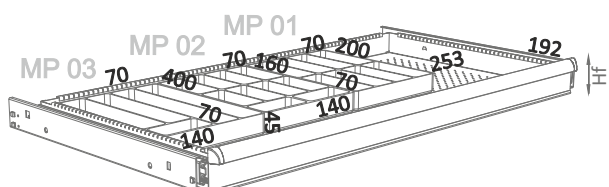

Ref. 143 MP 04-05-06  
 Hf 075-100

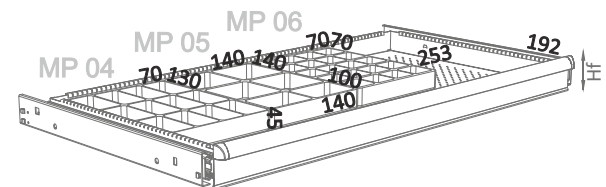

SERIE 143



CONSULTAR DISPONIBILIDAD MP 01-02-03-04-05-06 Hasta fin de existencias  
 VÉRIFIER LA DISPONIBILITÉ MP 01-02-03-04-05-06 Jusqu'à épuisement du stock  
 CHECK AVAILABILITY MP 01-02-03-04-05-06 Until end of stock

# NOMENCLATURA CAJONES

## NOMENCLATURE TIROIRS

### DRAWERS NAMING

**INFO: EX**

Ejemplo para la elección de cajones, válido para el resto de series.  
 Exemple de sélection de tiroirs, valable pour toutes les autres séries.  
 Example for the selection of drawers, valid for all other series.

SERIE SÉRIE SERIES  
 115/126/127  
 119  
 122  
 123  
 135

+ GUIAS GLISSIÈRES SLIDES  
 GS GT GT GT  
 100 50 100 200

+ CAJONES TIROIRS DRAWERS  
 Hf Altura frontal.  
 Hauteur frontale.  
 Front height.

ex.

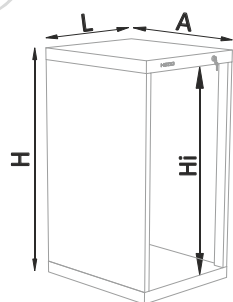

	LxAxH (mm)	Hi (mm)
135 1	515x600x700	600
135 2	515x600x1000	900
135 4	515x600x1400	1300

**e** 1 mm

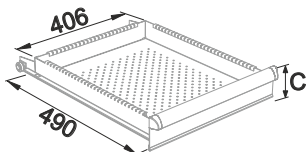

SERIE 135	C=75	C=100	C=125	C=150	C=200	C=250	C=300
	● x2	●	●	●	●	●	●

**e** 1 mm

**SERIE 135 2**  
 (515x600x1000)  
 Hi 900 mm

composición composition composition

SERIE	GUIAS	CAJONES
SÉRIE	GLISSIÈRES	TIROIRS
SERIE	SLIDES	DRAWERS
135	S100	C075
135	S100	C075
135	S100	C100
135	S100	C150
135	S100	C200
135	S100	C300

=Hi

**SERIE 135 2**  
 2u. 135 S100 C075  
 135 S100 C100  
 135 S100 C150  
 135 S100 C200  
 135 S100 C300

PEDIDO  
 COMMANDE  
 ORDER

# CAJONES

## TIROIRS

### DRAWERS

**INFO**

Para SERIE 115/119/143/122/123/135/126/127.  
 Pour SÉRIE 115/119/143/122/123/135/126/127.  
 For SERIES 115/119/143/122/123/135/126/127.

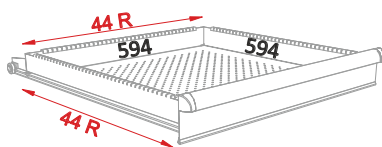

115-126-127

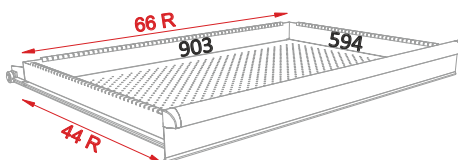

119

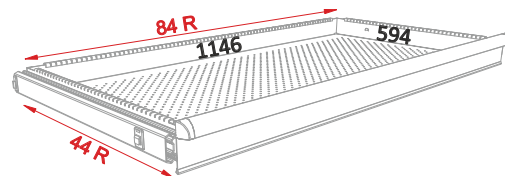

143

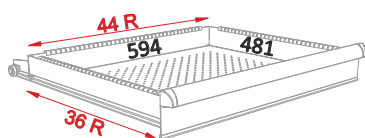

122

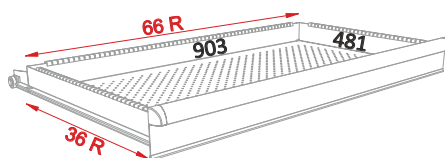

123

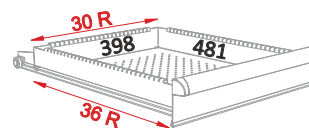

135

INFO: EX

Ejemplo para la elección de divisiones ranuradas y planas, válido para el resto de series.  
 Exemple de sélection des séparations et intercalaires, valable pour toutes les autres séries.  
 Example for the selection of divisions, valid for all other series.

**DIVISIONES DE CAJONES**  
**SEPARATIONS DES TIROIRS**  
**DRAWER DIVISORS**

SERIE 135 2

CAJON  
 TIROIR  
 DRAWER

135 S100 C150 Hf

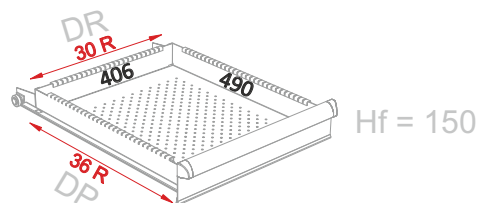

**DR** División ranurada.  
 Séparation rainurée.  
 Slotted division. / **DP** Divisiones planas.  
 Intercalaires.  
 Simple divisions.

SERIE 135

**DR** división ranurada séparations rainurées / slotted divisions

Longitud cajón: 406mm. Para tener 5 espacios, debo pedir 4 divisiones ranuradas.  
 Longueur tiroir: 406mm. Pour avoir 5 espaces, je dois demander 4 divisions rainurées.  
 Drawer length: 406mm. To have 5 spaces, I must ask 4 slotted divisors.

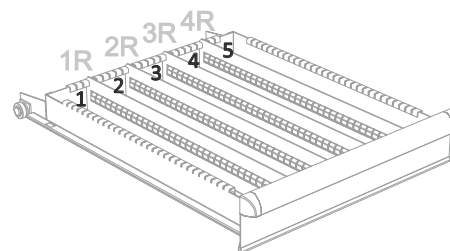

SERIE + Hf + R  
 SÉRIE + Hauteur frontale. + R  
 SERIE + Front height. + R

**DP** división plana intercalaires / simple division

Para tener 25 espacios, debo pedir 20 divisiones planas.  
 Pour avoir 25 espaces, je dois demander 20 séparations intercalaires.  
 To have to 25 spaces, I must be ask 20 simple divisions.

4 x 5 = 20 unidades  
 unités  
 units

30R = R 06  
 5 espacios  
 places  
 space

Hf + R  
 Hauteur frontale.  
 Front height.

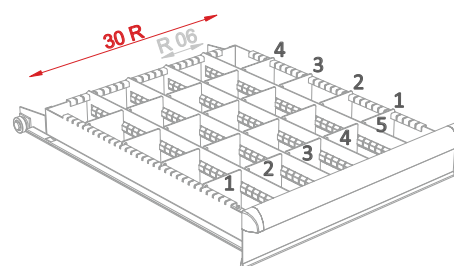

PEDIDO

COMMANDE

ORDER

SERIE 135 2

1u. 135 S100 C150

4u. 135 150 R

20u. 150 06

cajón tiroir / drawer

división ranurada division rainurée / slotted division DR

división plana intercalaire / simple division DP

**DR** posición position / position

Ubicación de las divisiones ranuradas y las divisiones planas.  
 Emplacement pour les divisions rainurées et les intercalaires.  
 Slotted and simple divisions emplacement.

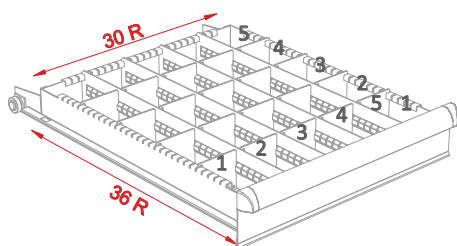

DR

30R = 6  
 5 espacios  
 places  
 space

ranuras ocupadas en horizontal  
 rainures occupées longitudinales  
 longitudinal occupied grooves

DP

36R = 7  
 5 espacios  
 places  
 space

ranuras ocupadas en vertical  
 rainures occupées verticales  
 vertical occupied grooves

# DIVISIONES INTERCALAIRES DIVISORS

## C50

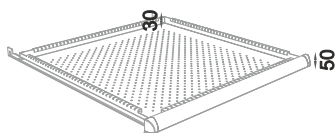

### CAJON TIROIR DRAWER C50 Hd 30 mm

DIVISIONES RANURADAS  
DIVISIONS RAINURÉES  
SLOTTED DIVISORS

#### SERIE 115,119

ref.	LxAxH
050 R	610x14x30 mm

DIVISIONES PLANAS  
INTERCALAIRES  
SIMPLE DIVISORS

ref.	Hf +R	Lu	Ld
050 04	42 mm	53 mm	
050 05	56 mm	67 mm	
050 06	70 mm	81 mm	
050 07	84 mm	95 mm	
050 08	98 mm	109 mm	
050 09	112 mm	123 mm	
050 10	126 mm	137 mm	
050 11	140 mm	151 mm	
050 12	154 mm	165 mm	
050 13	168 mm	179 mm	
050 14	182 mm	193 mm	
050 15	196 mm	207 mm	
050 16	210 mm	221 mm	
050 17	224 mm	235 mm	
050 18	238 mm	249 mm	
050 19	252 mm	263 mm	
050 20	266 mm	277 mm	
050 21	280 mm	291 mm	
050 22	294 mm	305 mm	
050 23	308 mm	319 mm	
050 24	322 mm	333 mm	
050 25	336 mm	347 mm	
050 26	350 mm	361 mm	
050 27	364 mm	375 mm	
050 28	378 mm	389 mm	
050 29	392 mm	403 mm	
050 30	406 mm	417 mm	
050 31	420 mm	431 mm	
050 32	434 mm	445 mm	
050 33	448 mm	459 mm	
050 34	462 mm	473 mm	
050 35	476 mm	487 mm	
050 36	490 mm	501 mm	
050 37	504 mm	515 mm	
050 38	518 mm	529 mm	
050 39	532 mm	543 mm	
050 40	546 mm	557 mm	
050 41	560 mm	571 mm	
050 42	574 mm	585 mm	
050 43	588 mm	599 mm	
050 44	602 mm	613 mm	

## C75

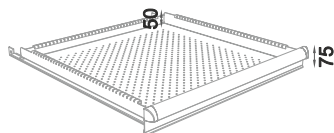

### CAJON TIROIR DRAWER C75 Hd 50 mm

DIVISIONES RANURADAS  
DIVISIONS RAINURÉES  
SLOTTED DIVISORS

#### SERIE 115,119,143

ref.	LxAxH
075 R	610x14x50 mm

#### SERIE 135,122,123

ref.	LxAxH
135 075 R	498x14x50 mm

DIVISIONES PLANAS  
INTERCALAIRES  
SIMPLE DIVISORS

ref.	Hf +R	Lu	Ld
075 04	42 mm	53 mm	
075 05	56 mm	67 mm	
075 06	70 mm	81 mm	
075 07	84 mm	95 mm	
075 08	98 mm	109 mm	
075 09	112 mm	123 mm	
075 10	126 mm	137 mm	
075 11	140 mm	151 mm	
075 12	154 mm	165 mm	
075 13	168 mm	179 mm	
075 14	182 mm	193 mm	
075 15	196 mm	207 mm	
075 16	210 mm	221 mm	
075 17	224 mm	235 mm	
075 18	238 mm	249 mm	
075 19	252 mm	263 mm	
075 20	266 mm	277 mm	
075 21	280 mm	291 mm	
075 22	294 mm	305 mm	
075 23	308 mm	319 mm	
075 24	322 mm	333 mm	
075 25	336 mm	347 mm	
075 26	350 mm	361 mm	
075 27	364 mm	375 mm	
075 28	378 mm	389 mm	
075 29	392 mm	403 mm	
075 30	406 mm	417 mm	
075 31	420 mm	431 mm	
075 32	434 mm	445 mm	
075 33	448 mm	459 mm	
075 34	462 mm	473 mm	
075 35	476 mm	487 mm	
075 36	490 mm	501 mm	
075 37	504 mm	515 mm	
075 38	518 mm	529 mm	
075 39	532 mm	543 mm	
075 40	546 mm	557 mm	
075 41	560 mm	571 mm	
075 42	574 mm	585 mm	
075 43	588 mm	599 mm	
075 44	602 mm	613 mm	

## C100

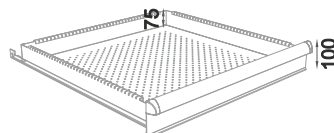

### CAJON TIROIR DRAWER C100 Hd 62 mm

DIVISIONES RANURADAS  
DIVISIONS RAINURÉES  
SLOTTED DIVISORS

#### SERIE 115,119,143

ref.	LxAxH
100 R	610x14x75 mm

#### SERIE 135,122,123

ref.	LxAxH
135 100 R	498x14x75 mm

DIVISIONES PLANAS  
INTERCALAIRES  
SIMPLE DIVISORS

ref.	Hf +R	Lu	Ld
100 04	42 mm	53 mm	
100 05	56 mm	67 mm	
100 06	70 mm	81 mm	
100 07	84 mm	95 mm	
100 08	98 mm	109 mm	
100 09	112 mm	123 mm	
100 10	126 mm	137 mm	
100 11	140 mm	151 mm	
100 12	154 mm	165 mm	
100 13	168 mm	179 mm	
100 14	182 mm	193 mm	
100 15	196 mm	207 mm	
100 16	210 mm	221 mm	
100 17	224 mm	235 mm	
100 18	238 mm	249 mm	
100 19	252 mm	263 mm	
100 20	266 mm	277 mm	
100 21	280 mm	291 mm	
100 22	294 mm	305 mm	
100 23	308 mm	319 mm	
100 24	322 mm	333 mm	
100 25	336 mm	347 mm	
100 26	350 mm	361 mm	
100 27	364 mm	375 mm	
100 28	378 mm	389 mm	
100 29	392 mm	403 mm	
100 30	406 mm	417 mm	
100 31	420 mm	431 mm	
100 32	434 mm	445 mm	
100 33	448 mm	459 mm	
100 34	462 mm	473 mm	
100 35	476 mm	487 mm	
100 36	490 mm	501 mm	
100 37	504 mm	515 mm	
100 38	518 mm	529 mm	
100 39	532 mm	543 mm	
100 40	546 mm	557 mm	
100 41	560 mm	571 mm	
100 42	574 mm	585 mm	
100 43	588 mm	599 mm	
100 44	602 mm	613 mm	

## C125

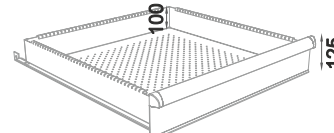

### CAJON TIROIR DRAWER C125 Hd 87 mm

DIVISIONES RANURADAS  
DIVISIONS RAINURÉES  
SLOTTED DIVISORS

#### SERIE 115,119,143

ref.	LxAxH
125 R	610x14x100 mm

#### SERIE 135,122,123

ref.	LxAxH
135 125 R	498x14x95 mm

DIVISIONES PLANAS  
INTERCALAIRES  
SIMPLE DIVISORS

ref.	Hf +R	Lu	Ld
125 04	42 mm	53 mm	
125 05	56 mm	67 mm	
125 06	70 mm	81 mm	
125 07	84 mm	95 mm	
125 08	98 mm	109 mm	
125 09	112 mm	123 mm	
125 10	126 mm	137 mm	
125 11	140 mm	151 mm	
125 12	154 mm	165 mm	
125 13	168 mm	179 mm	
125 14	182 mm	193 mm	
125 15	196 mm	207 mm	
125 16	210 mm	221 mm	
125 17	224 mm	235 mm	
125 18	238 mm	249 mm	
125 19	252 mm	263 mm	
125 20	266 mm	277 mm	
125 21	280 mm	291 mm	
125 22	294 mm	305 mm	
125 23	308 mm	319 mm	
125 24	322 mm	333 mm	
125 25	336 mm	347 mm	
125 26	350 mm	361 mm	
125 27	364 mm	375 mm	
125 28	378 mm	389 mm	
125 29	392 mm	403 mm	
125 30	406 mm	417 mm	
125 31	420 mm	431 mm	
125 32	434 mm	445 mm	
125 33	448 mm	459 mm	
125 34	462 mm	473 mm	
125 35	476 mm	487 mm	
125 36	490 mm	501 mm	
125 37	504 mm	515 mm	
125 38	518 mm	529 mm	
125 39	532 mm	543 mm	
125 40	546 mm	557 mm	
125 41	560 mm	571 mm	
125 42	574 mm	585 mm	
125 43	588 mm	599 mm	
125 44	602 mm	613 mm	

**Hf** Altura frontal cajón.  
Hauteur frontale tiroir.  
Drawer front height.

**R** Ranuras ocupadas.  
Rainures occupées.  
Slots to be used.

**Lu** Longitud útil.  
Longueur utile.  
Useful length width.

**Ld** Longitud real de la pieza.  
Longueur réelle de la pièce.  
Real length width from piece.

**DIVISIONES**  
**SEPARATIONS**  
**DIVISORS**

**C150**

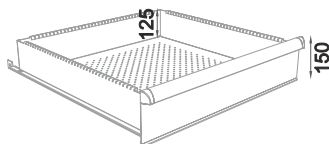

**C200**

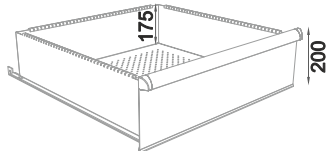

**C250**

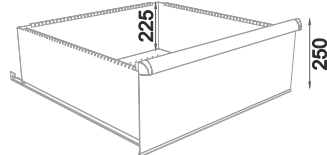

**C300**

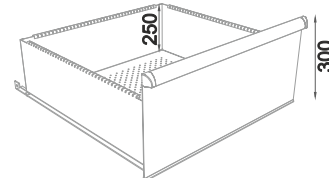

**CAJON TIROIR DRAWER C150** Hd 112 mm

DIVISIONES RANURADAS  
 DIVISIONS RAINURÉES  
 SLOTTED DIVISORS

**SERIE 115,119,143**

ref.	LxAxH
150 R	610x14x125 mm

**SERIE 135,122,123**

ref.	LxAxH
135 150 R	498x14x125 mm

DIVISIONES PLANAS  
 INTERCALAIRES  
 SIMPLE DIVISORS

ref.	Hf +R	Lu	Ld
150 04	42 mm	53 mm	
150 05	56 mm	67 mm	
150 06	70 mm	81 mm	
150 07	84 mm	95 mm	
150 08	98 mm	109 mm	
150 09	112 mm	123 mm	
150 10	126 mm	137 mm	
150 11	140 mm	151 mm	
150 12	154 mm	165 mm	
150 13	168 mm	179 mm	
150 14	182 mm	193 mm	
150 15	196 mm	207 mm	
150 16	210 mm	221 mm	
150 17	224 mm	235 mm	
150 18	238 mm	249 mm	
150 19	252 mm	263 mm	
150 20	266 mm	277 mm	
150 21	280 mm	291 mm	
150 22	294 mm	305 mm	
150 23	308 mm	319 mm	
150 24	322 mm	333 mm	
150 25	336 mm	347 mm	
150 26	350 mm	361 mm	
150 27	364 mm	375 mm	
150 28	378 mm	389 mm	
150 29	392 mm	403 mm	
150 30	406 mm	417 mm	
150 31	420 mm	431 mm	
150 32	434 mm	445 mm	
150 33	448 mm	459 mm	
150 34	462 mm	473 mm	
150 35	476 mm	487 mm	
150 36	490 mm	501 mm	
150 37	504 mm	515 mm	
150 38	518 mm	529 mm	
150 39	532 mm	543 mm	
150 40	546 mm	557 mm	
150 41	560 mm	571 mm	
150 42	574 mm	585 mm	
150 43	588 mm	599 mm	
150 44	602 mm	613 mm	

**CAJON TIROIR DRAWER C200** Hd 162 mm

DIVISIONES RANURADAS  
 DIVISIONS RAINURÉES  
 SLOTTED DIVISORS

**SERIE 115,119,143**

ref.	LxAxH
200 R	610x14x175 mm

**SERIE 135,122,123**

ref.	LxAxH
135 200 R	498x14x175 mm

DIVISIONES PLANAS  
 INTERCALAIRES  
 SIMPLE DIVISORS

ref.	Hf +R	Lu	Ld
200 04	42 mm	53 mm	
200 05	56 mm	67 mm	
200 06	70 mm	81 mm	
200 07	84 mm	95 mm	
200 08	98 mm	109 mm	
200 09	112 mm	123 mm	
200 10	126 mm	137 mm	
200 11	140 mm	151 mm	
200 12	154 mm	165 mm	
200 13	168 mm	179 mm	
200 14	182 mm	193 mm	
200 15	196 mm	207 mm	
200 16	210 mm	221 mm	
200 17	224 mm	235 mm	
200 18	238 mm	249 mm	
200 19	252 mm	263 mm	
200 20	266 mm	277 mm	
200 21	280 mm	291 mm	
200 22	294 mm	305 mm	
200 23	308 mm	319 mm	
200 24	322 mm	333 mm	
200 25	336 mm	347 mm	
200 26	350 mm	361 mm	
200 27	364 mm	375 mm	
200 28	378 mm	389 mm	
200 29	392 mm	403 mm	
200 30	406 mm	417 mm	
200 31	420 mm	431 mm	
200 32	434 mm	445 mm	
200 33	448 mm	459 mm	
200 34	462 mm	473 mm	
200 35	476 mm	487 mm	
200 36	490 mm	501 mm	
200 37	504 mm	515 mm	
200 38	518 mm	529 mm	
200 39	532 mm	543 mm	
200 40	546 mm	557 mm	
200 41	560 mm	571 mm	
200 42	574 mm	585 mm	
200 43	588 mm	599 mm	
200 44	602 mm	613 mm	

**CAJON TIROIR DRAWER C250** Hd 212 mm

DIVISIONES RANURADAS  
 DIVISIONS RAINURÉES  
 SLOTTED DIVISORS

**SERIE 115,119,143**

ref.	LxAxH
250 R	610x14x225 mm

**SERIE 135,122,123**

ref.	LxAxH
135 250 R	498x14x225 mm

DIVISIONES PLANAS  
 INTERCALAIRES  
 SIMPLE DIVISORS

ref.	Hf +R	Lu	Ld
250 04	42 mm	53 mm	
250 05	56 mm	67 mm	
250 06	70 mm	81 mm	
250 07	84 mm	95 mm	
250 08	98 mm	109 mm	
250 09	112 mm	123 mm	
250 10	126 mm	137 mm	
250 11	140 mm	151 mm	
250 12	154 mm	165 mm	
250 13	168 mm	179 mm	
250 14	182 mm	193 mm	
250 15	196 mm	207 mm	
250 16	210 mm	221 mm	
250 17	224 mm	235 mm	
250 18	238 mm	249 mm	
250 19	252 mm	263 mm	
250 20	266 mm	277 mm	
250 21	280 mm	291 mm	
250 22	294 mm	305 mm	
250 23	308 mm	319 mm	
250 24	322 mm	333 mm	
250 25	336 mm	347 mm	
250 26	350 mm	361 mm	
250 27	364 mm	375 mm	
250 28	378 mm	389 mm	
250 29	392 mm	403 mm	
250 30	406 mm	417 mm	
250 31	420 mm	431 mm	
250 32	434 mm	445 mm	
250 33	448 mm	459 mm	
250 34	462 mm	473 mm	
250 35	476 mm	487 mm	
250 36	490 mm	501 mm	
250 37	504 mm	515 mm	
250 38	518 mm	529 mm	
250 39	532 mm	543 mm	
250 40	546 mm	557 mm	
250 41	560 mm	571 mm	
250 42	574 mm	585 mm	
250 43	588 mm	599 mm	
250 44	602 mm	613 mm	

**CAJON TIROIR DRAWER C300** Hd 262 mm

DIVISIONES RANURADAS  
 DIVISIONS RAINURÉES  
 SLOTTED DIVISORS

**SERIE 127**

ref.	LxAxH
300 R	610x14x250 mm

DIVISIONES PLANAS  
 INTERCALAIRES  
 SIMPLE DIVISORS

ref.	Hf +R	Lu	Ld
300 04	42 mm	53 mm	
300 05	56 mm	67 mm	
300 06	70 mm	81 mm	
300 07	84 mm	95 mm	
300 08	98 mm	109 mm	
300 09	112 mm	123 mm	
300 10	126 mm	137 mm	
300 11	140 mm	151 mm	
300 12	154 mm	165 mm	
300 13	168 mm	179 mm	
300 14	182 mm	193 mm	
300 15	196 mm	207 mm	
300 16	210 mm	221 mm	
300 17	224 mm	235 mm	
300 18	238 mm	249 mm	
300 19	252 mm	263 mm	
300 20	266 mm	277 mm	
300 21	280 mm	291 mm	
300 22	294 mm	305 mm	
300 23	308 mm	319 mm	
300 24	322 mm	333 mm	
300 25	336 mm	347 mm	
300 26	350 mm	361 mm	
300 27	364 mm	375 mm	
300 28	378 mm	389 mm	
300 29	392 mm	403 mm	
300 30	406 mm	417 mm	
300 31	420 mm	431 mm	
300 32	434 mm	445 mm	
300 33	448 mm	459 mm	
300 34	462 mm	473 mm	
300 35	476 mm	487 mm	
300 36	490 mm	501 mm	
300 37	504 mm	515 mm	
300 38	518 mm	529 mm	
300 39	532 mm	543 mm	
300 40	546 mm	557 mm	
300 41	560 mm	571 mm	
300 42	574 mm	585 mm	
300 43	588 mm	599 mm	
300 44	602 mm	613 mm	



Los divisiones se sirven en acero galvanizado.  
 Les séparations sont fournies en acier galvanisé.  
 The divisions are supplied in galvanised steel.