



ACCESORIOS
ACCESSOIRES
ACCESSORIES



i Para colores no estándar hay coste adicional (consultar condiciones).
Pour les couleurs non standard il y a un coût supplémentaire (consulter les conditions).
For non-standard colours there is an additional cost (consult conditions).



INFORMACIÓN

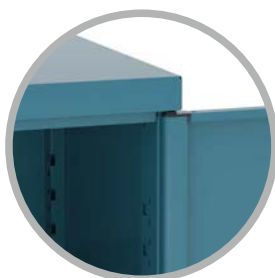

Apertura 180°.
Ouverture 180°.
Opening 180°.



Cierre con llave.
Fermeture à clé.
Key Locking.



Bandejas regulables cada 25mm.
Plateaux réglables chaque 25mm.
Shelves adjustable every 25mm.

ARMARIOS CON PUERTAS

ARMOIRES À PORTES

CABINETS WITH DOORS

- [ES]**
 - Gran variedad de medidas y configuraciones.
 - Diseño robusto y resistente.
 - Aperturas de puertas de 180° .
 - Cierre dos puntos.
 - Bandejas graduables cada 25mm.
 - Puertas de metacrilato en opción.
 - Cierre electrónico. Sistema RFID en opción.
 - Plazo de entrega 10 días laborables.
 - Color estándar azul martelé posibilidad colores en opción.
- [FR]**
 - Grande variété de tailles et configurations.
 - Conception robuste et résistante.
 - Ouverture des portes à 180° .
 - Fermeture à deux points.
 - Etagères réglables chaque 25mm.
 - Portes en option de methacrylate.
 - Système RFID en option.
 - Délai de livraison 10 jours ouvrables.
 - Couleur standard bleu martelé possibilité teintes en option.
- [EN]**
 - Wide range of sizes and configurations.
 - Strong and resistant design.
 - 180° Opening doors.
 - 2 point closure.
 - Adjustable shelves every 25mm.
 - Methacrylate doors in option.
 - Optional RFID system.
 - Delivery time 10 working days.
 - Standard colour hammered blue possibility optional colours.

INFORMACIÓN INFORMATION



Grososres de chapa
Épaisseurs de tôle
Sheet thicknesses

e 1,2 mm
paneles
panneaux / panels

e 0,6 mm
puertas
portes / doors



e 1 mm
armazón
châssis / frame

e 0,8 mm
cajones
tiroirs / drawers

e 1 mm
bandejas
plateaux / shelves

Cajones
Tiroirs
Drawers

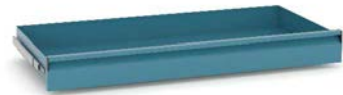

Apertura del 100% permiten cargas repartidas de 50Kg.
L'ouverture à 100% permet des charges réparties de 50Kg.
100% opening allows distributed loads of 50Kg.

Información
Informations
Information



Cierre con llave.
Fermeture à clé.
Key Locking.



Apertura 180°.
Ouverture 180°.
Opening 180°.

Gama de producto
Gamme de produits
Product range

BAJOS
B A S
BASE



SERIE 125



SERIE 136 1



SERIE 126



Ref. 159 B

PUPITRES
BUREAUX
DESKS

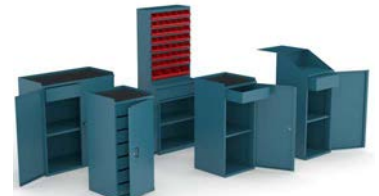

SERIE 154

ALTOS
HAUTES
T A L L



SERIE 157



SERIE 158



SERIE 159

GRANDES DIMENSIONES
GRANDES DIMENSIONS
LARGE DIMENSIONS



SERIE 159 F6



SERIE 162

PORTA CUBETAS
PORTE-BACS
TRAY HOLDER



Ref. 157 C



Ref. 158 C



Ref. 159 C

CIERRE PERSIANA
FERMETURE À RIDEAU
SHUTTER CLOSING



Ref. 159 P



Ref. 159 P B

PUERTA CORREDERA
PORTE COULISSANTE
SLIDING DOOR



SERIE 162 PC

ESQUINEROS
C O I N S
CORNERS



SERIE 159 CA



SERIE 159 B CA

PORTA CUBETAS COMPLETOS
PORTE-BACS COMPLET
FULL TRAY HOLDER

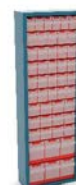



SERIE V-420



SERIE V-ABULL



SERIE 125

Ref. 125 1

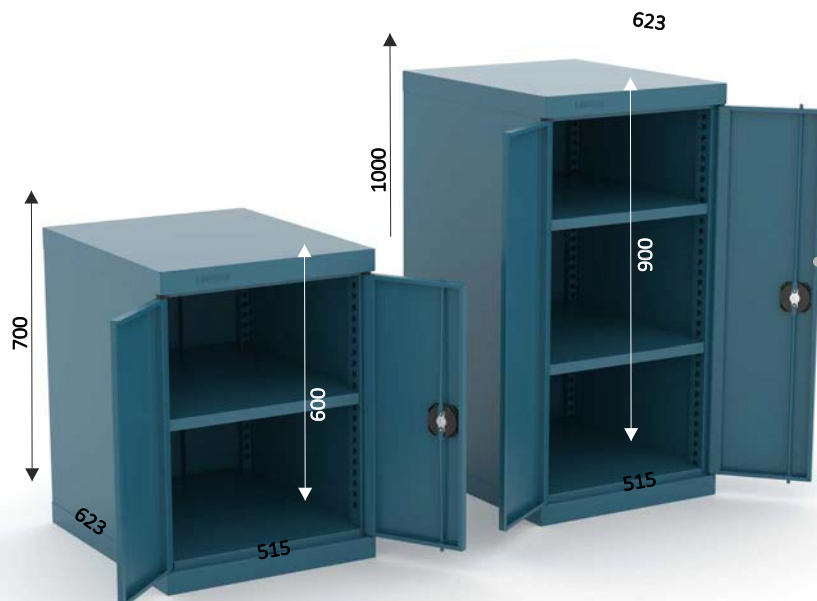
 38 Kg
 550 x 670 x 830 mm
 1x Ref. 125 BG





Ref. 125 2

 47 Kg
 550 x 670 x 1130 mm
 2x Ref. 125 BG

Accesorios opcionales
 Accessoires optionnels
 Optional accessories

Ref. 125 BG

 2,8 Kg
 1 mm
 bandeja
 plateau
 tray



Ref. CE P 1

 Cierre electrónico
 Verrou électronique
 Electronic locking
 REF. CE P 1 - REF. CE P 1 TM -
 REF. CE P 1 TU





 0.6 mm
 puertas
 portes/ doors
 1 mm

 Accesorio: estanteria 125 BG, graduable cada 25mm.
 Accessoire: étagère 125 BG, réglable chaque 25mm.
 Accessory: shelf 125 BG, adjustable every 25mm.

SERIE 136 1

Ref. 136 1

 41 Kg
 550 x 670 x 960 mm
 1x Ref. 125 BG



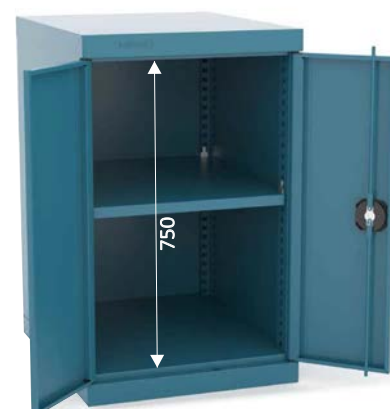

Cierre con llave.
 Fermeture à clé.
 Key Locking.



Accesorios opcionales
 Accessoires optionnels
 Optional accessories

Ref. 125 BG

 2,8 Kg
 1 mm
 bandeja
 plateau
 tray



Ref. CE P 1

 Cierre electrónico
 Verrou électronique
 Electronic locking
 REF. CE P 1 - REF. CE P 1 TM -
 REF. CE P 1 TU



 0.6 mm
 puertas
 portes/ doors
 1 mm

 Accesorio: estanteria 125 BG, graduable cada 25mm.
 Accessoire: étagère 125 BG, réglable chaque 25mm.
 Accessory: shelf 125 BG, adjustable every 25mm.

SERIE **126**

Accesorios opcionales
Accessoires optionnels
Optional accessories



Cierre con llave.
Fermeture à clé.
Key Locking.



Ref. **126 1**

Ref. **126 2**

Ref. **126 4**



Estanterías graduables cada 25mm.
Étagères réglables chaque 25mm.
Adjustable shelves every 25mm.



Complete su armario con cajones, estanterías y bandejas.
Compléter votre armoire avec des tiroirs, des étagères et plateaux.
Complete your cabinet with drawers, shelves and trays.

e 0.6 mm
puertas
portes/ doors
e 1 mm

Ref. **126 BG**
KG 7,08 Kg
e 1,5 mm



Ref. **127 BE T100**
e 1,5 mm



Ref. **127 BE T200**
e 1,5 mm

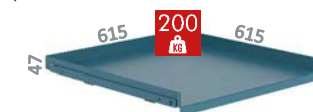

Ref. **127 T200 50**
e 2 mm

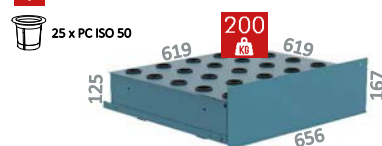

Ref. **127 T200 40**
e 1,5 mm



Ref. **127 T100 300**
e 1,5 mm

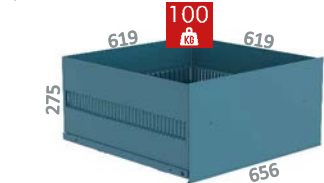

Ref. **CE P 1**

Cierre electrónico
Verrou électronique
Electronic locking
REF. CE P 1 - REF. CE P 1 TM -
REF. CE P 1 TU

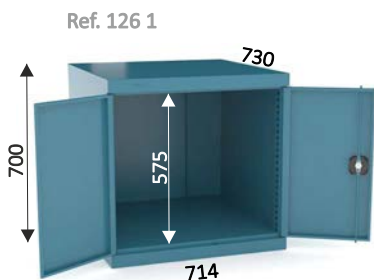

Ref. **126 1**

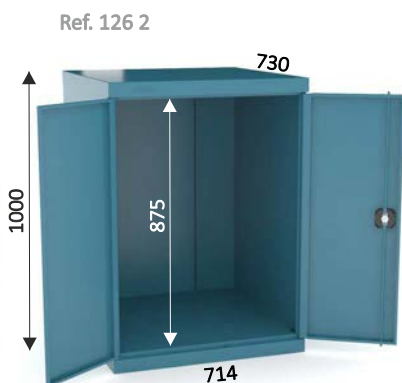

Ref. **126 2**

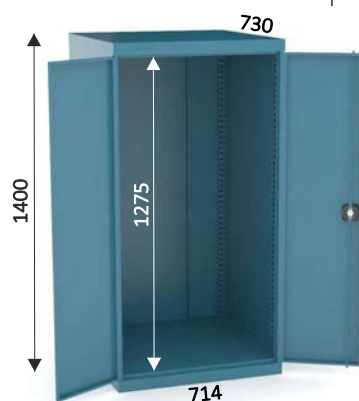

Ref. **126 4**

KG 41 Kg
mm 750 x 750 x 830 mm

KG 49 Kg
mm 750 x 750 x 1130 mm

KG 55 Kg
mm 750 x 750 x 1530 mm



Guía telescópica, apertura 100%.
Guide télescopique, ouverture 100%.
Telescopic guide, 100% opening.

Información de opciones estándares en catálogo general en web.
Information sur les options standard dans le catalogue général sur le web.
Information of standard options in the general catalog on web.

Porta-conos /
Porte-cônes / Cone-holder



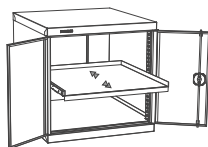

Ref. **126 1**

Ref. **126 1 1**
 46 Kg
 1x 126 BG

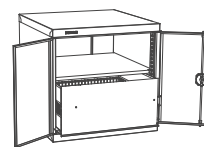

Ref. **126 1 2**
 51 Kg
 1x 126 BE T100



Ref. **126 1 3**
 67,5 Kg
 1x 126 BG
 1x 127 T100 300

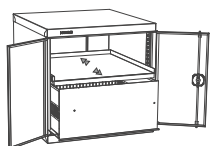

Ref. **126 1 4**
 76 Kg
 1x 127 BE T100
 1x 127 T100 300

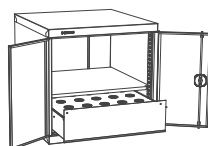

Ref. **126 1 5**
 65,5 Kg
 1x 126 BG
 1x 127 T200 50
 25u. PC ISO 50

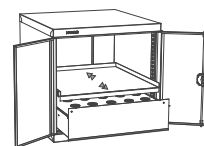

Ref. **126 1 6**
 74 Kg
 1x 127 BE T100
 1x 127 T200 50
 25u. PC ISO 50

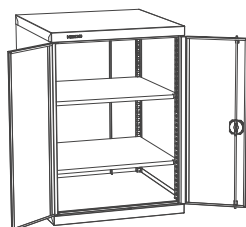
Ref. **126 2**

Ref. **126 2 1**
 52 Kg
 2x 126 BG

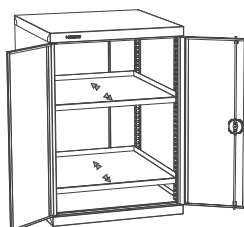

Ref. **126 2 2**
 69 Kg
 2x 127 BE T100

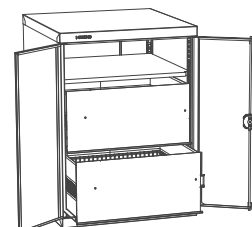

Ref. **126 2 3**
 100 Kg
 1x 126 BG
 2x 127 T100 300

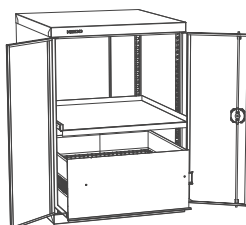

Ref. **126 2 4**
 84 Kg
 1x 127 BE T100
 1x 127 T100 300

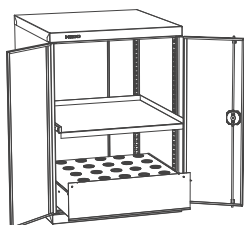

Ref. **126 2 5**
 82 Kg
 1x 127 BE T100
 1x 127 T200 50
 25u. PC ISO 50

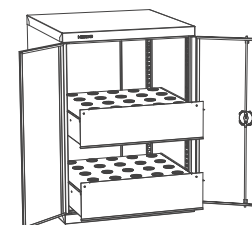

Ref. **126 2 6**
 100 Kg
 1x 127 T200 40
 25u. PC ISO 40
 1x 127 T200 50
 25u. PC ISO 50

Ref. **126 4**

Ref. **126 4 1**
 59,5 Kg
 3x 126 BG

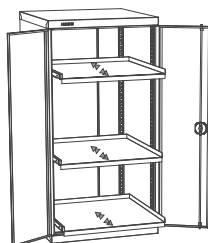

Ref. **126 4 2**
 85 Kg
 3x 127 BE T100

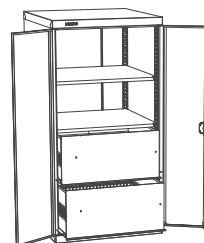

Ref. **126 4 3**
 108 Kg
 2x 126 BG
 2x 127 T100 300

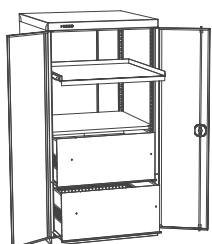

Ref. **126 4 4**
 116,5 Kg
 1x 127 BE T100
 1x 126 BG
 2x 127 T100 300

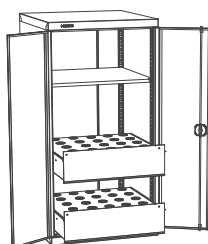

Ref. **126 4 5**
 99,5 Kg
 1x 126 BG
 1x 127 T200 40
 25u. PC ISO 40
 1x 127 T200 50
 25u. PC ISO 50

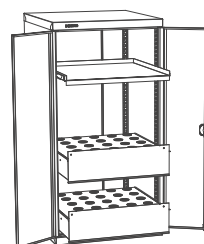

Ref. **126 4 6**
 108 Kg
 1x 126 BE T100
 1x 127 T200 40
 25u. PC ISO 40
 1x 127 T200 50
 25u. PC ISO 50

SERIE 154

Pupitres y armarios bajos para pie de máquina.
 Pupitre et armoires basses pour le pied de machine.
 Desk and low cabinets for machine foot.

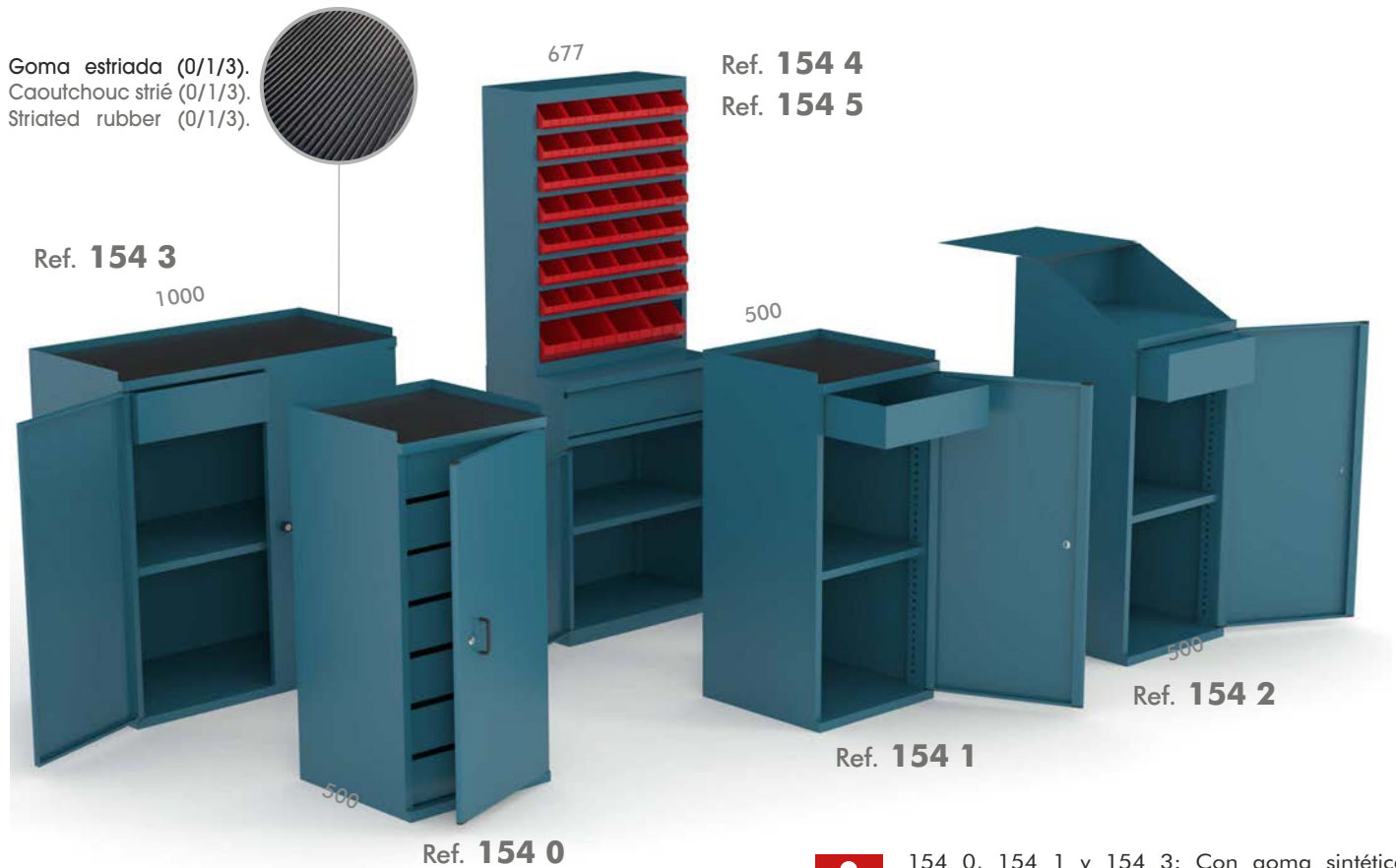

Goma estriada (0/1/3).
 Caoutchouc strié (0/1/3).
 Striated rubber (0/1/3).

Ref. 154 3

1000

677

Ref. 154 4
Ref. 154 5

500

Ref. 154 2
Ref. 154 1
Ref. 154 0

154 0, 154 1 y 154 3: Con goma sintética.
 154 0, 154 1 et 154 3: Avec gomme synthétique.
 154 0, 154 1 and 154 3: With synthetic rubber.



Accesorios opcionales
Accessoires optionnels
Optional accessories
Ref. 154 1 01
 2,2 Kg

 1 mm

 bandeja
 plateau
 tray

Ref. 154 3 01
 4 Kg

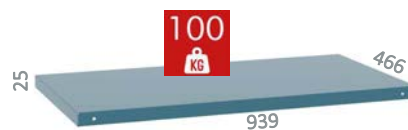
 1 mm

 bandeja
 plateau
 tray

Ref. 154 5 01
 2,3 Kg

 1 mm

 bandeja
 plateau
 tray



Estanterías graduables cada 25mm.
 Étagères réglables chaque 25mm.
 Adjustable shelves every 25mm.



Carga máxima repartida 100 Kg.
 Charge maximum répartie 100 Kg.
 Maximum distributed load 100 Kg.

Información adicional
Autres informations
Additional Information

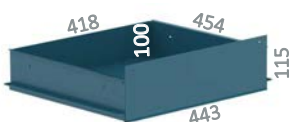

Carga máxima repartida 15 Kg.
 Charge maximum répartie 15 Kg.
 Maximum distributed load 15 Kg.

 3,5 Kg

 0,8 mm

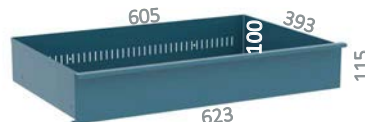
cajón ref. 154 0-1-2-3
 tiroir réf. 154 0-1-2-3
 drawer ref. 154 0-1-2-3

 5 Kg

 0,8 mm

cajón ref. 154 0-1-2-3
 tiroir réf. 154 0-1-2-3
 drawer ref. 154 0-1-2-3

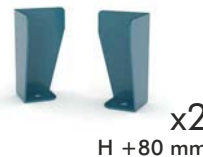



Juego de dos pies.
 Jeu de deux pieds.
 Two feet set.



Ruedas de nylon Ø = 100 mm.
 Roues de nylon Ø = 100 mm.
 Nylon wheels Ø = 100 mm.

Ref. 154 0

 64 Kg
 670 x 550 x 1200 mm



Ref. 154 0 P

 65 Kg H1125mm





Ref. 154 0 R

 75 Kg H1185mm



Ref. 154 1

 35 Kg
 670 x 550 x 1200 mm

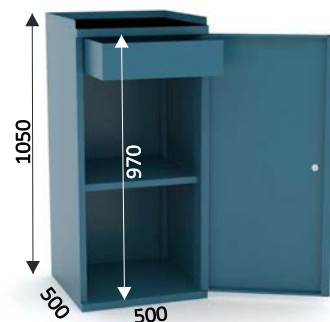

Ref. 154 1 P

 65 Kg H1125mm





Ref. 154 1 R

 75 Kg H1185mm



Ref. 154 2

 37 Kg
 670 x 550 x 1200 mm

Ref. 154 1 01

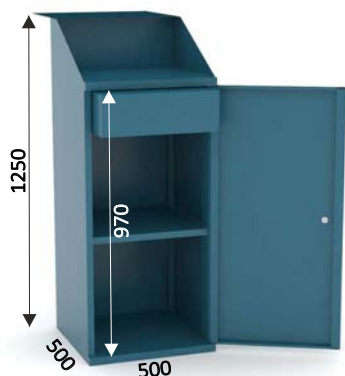

Ref. 154 2 P

 38 Kg H1325mm





Ref. 154 2 R

 48 Kg H1385mm



Ref. 154 3

 50 Kg
 1200 x 800 x 1200 mm

Ref. 154 3 01

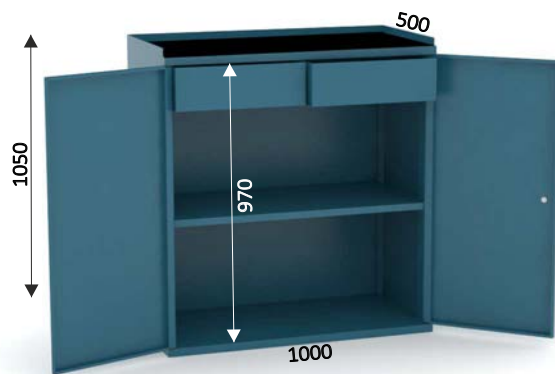

Ref. 154 3 P

 52 Kg H1125mm





Ref. 154 3 R

 63 Kg H1185mm



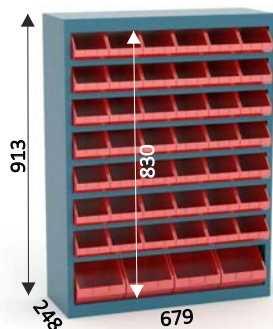

Ref. 154 4

 35 Kg
 670 x 550 x 1200 mm
 0,8 mm



Ref. 154 5

 32 Kg
 670 x 550 x 1200 mm

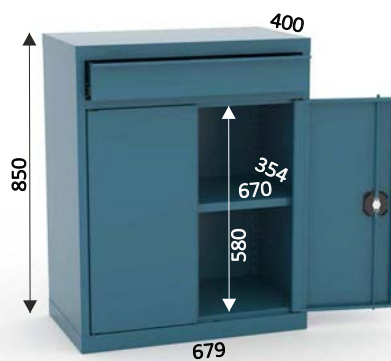

Permite fijación a pared.
 Permet la fixation au mur.
 It allows wall fixation.

Información de opciones estándares en catálogo general en web.
 Information sur les options standard dans le catalogue général sur le web.
 Information of standard options in the general catalog on web.

SERIE 157

SERIE 157

Armario 1 puerta
Armoire 1 porte
Cabinet with 1 door

KG 40 Kg
mm 670 x 550 x 2130 mm

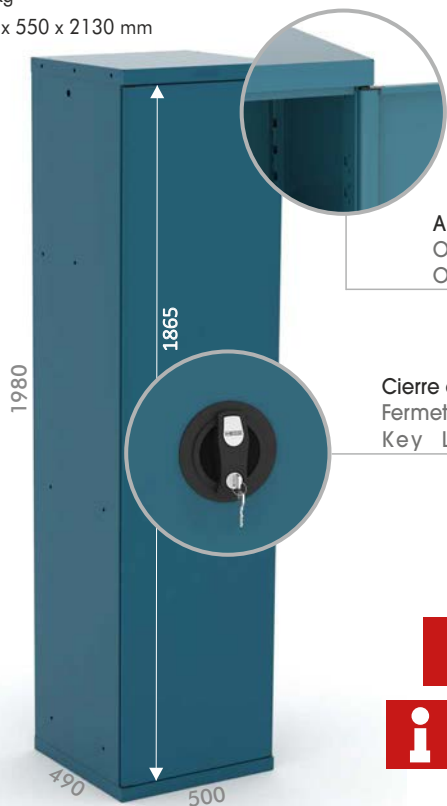

Apertura 180°.
Ouverture 180°.
Opening 180°.

Cierre con llave.
Fermeture à clé.
Key Locking.

Accesorios opcionales
Accessoires optionnels
Optional accessories

Ref. CE P 1

KG Cierre electrónico
Verrou électronique
Electronic locking

REF. CE P 1
REF. CE P 1 TM
REF. CE P 1 TU



i Estanterías graduables cada 25mm.
Étagères réglables chaque 25mm.
Adjustable shelves every 25mm.

i Opción puertas de metacrilato.
Option portes de méthacrylate.
Methacrylate doors option.

Ref. 157 2P

Armario 2 puertas
Armoire 2 portes
Cabinet with 2 doors

KG 45 Kg
mm 670 x 550 x 2130 mm

Ref. 157 C

Armario con soportes para cubetas V-BULL 1, 2, 3
Armoire avec supports pour bacs à bec V-BULL 1, 2, 3
Cabinet with V-BULL 1, 2, 3 tray supports.

KG 45 Kg
mm 670 x 550 x 2130 mm

! ancho 260 mm.
profondeur 260 mm.
width 260 mm.

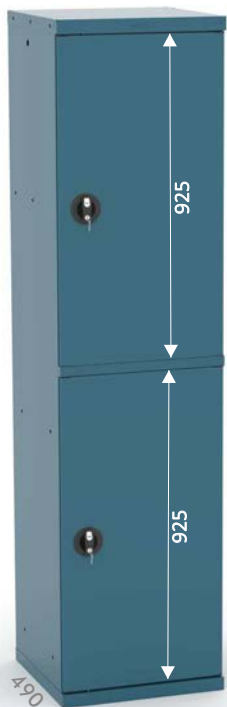

Ref. V-BULL 1

KG 0,046 kg **mm** 0,4 l



Ref. V-BULL 2

KG 0,110 kg **mm** 1,2 l



Ref. V-BULL 3

KG 0,226 kg **mm** 3,5 l



Ref. 157 BG

KG 2 Kg
mm 0,8 mm

bandeja
plateau
tray

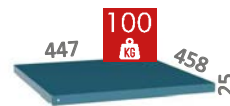

Ref. 157 BP

KG 2,5 Kg
mm 0,8 mm

bandeja para perchas no incluidas
plateau pour cintres non compris
tray for hangers not included

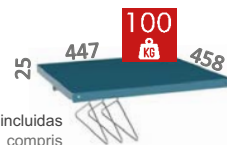

Ref. 157 T50 BE

KG 3,5 Kg
mm 0,8 mm

bandeja extraíble
plateau coulissant
removable tray

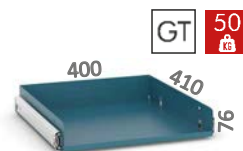

Ref. 157 S M

soporte móvil
support mobile
mobile support

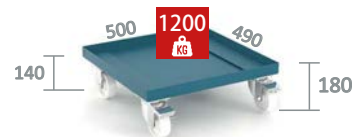

Ref. 157 P

mm 0,6 mm



Ref. 157 PV

mm 0,6 mm



Ref. 157 SC

KG 4 Kg
mm 1 mm



Ref. 157 CP

KG 0,5 Kg
mm 4,92 l



Ref. 157 CG

KG 0,75 Kg
mm 7,56 l



Ref. 157 TI

KG 4,22 Kg
mm 1 mm

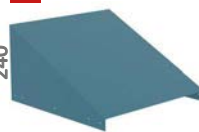

Ref. 157 TC

mm 1,5 mm



Ref. 157 T50 C100

KG 3,81 Kg
mm 0,8 mm



Ref. 157 T50 C200

KG 5,5 Kg
mm 0,8 mm

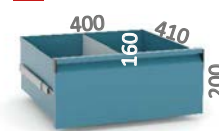

159 DP 100

MAX 3 separadores
séparateur
dividers **GT** **KG** 50

Ref. 157 PPF

KG 6,22 Kg
mm 1,2 mm

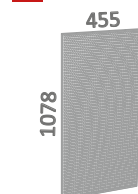

Ref. 159 PPL

KG 5,5 Kg
mm 1,2 mm

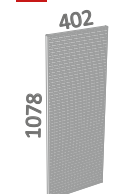

Ref. 156 P

H +80 mm
mm 2 mm



x2

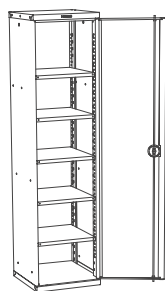

Ref. **157 1**
 50 Kg
 5x 157 BG

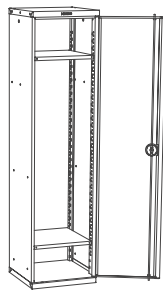

Ref. **157 2**
 42 Kg
 1x 157 BP
 1x 157 BG

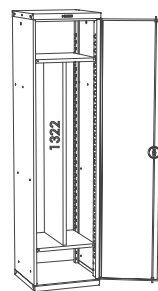

Ref. **157 3**
 50 Kg
 1x 157 BP
 1x 157 SC
 1x 157 BG

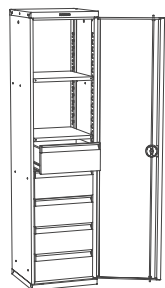

Ref. **157 4**
 72,5 Kg
 2x 157 BG
 5x 157 T50 C200

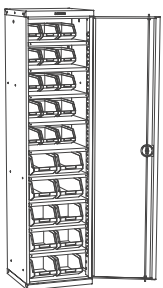

Ref. **157 5**
 73 Kg
 9x 157 BG
 15x 157 CP
 10x 157 CG
 10x 157 TC

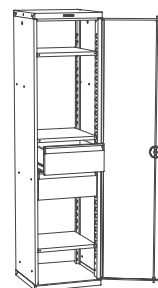

Ref. **157 6**
 57 Kg
 3x 157 BG
 2x 157 T50 C200

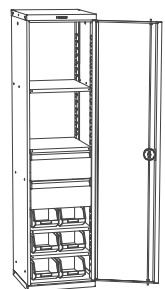

Ref. **157 7**
 47 Kg
 4x 157 BG
 2x 157 T50 C200
 6x 157 CG
 3x 157 TC

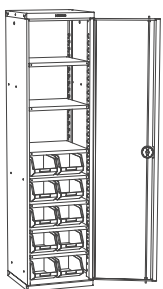

Ref. **157 8**
 70 Kg
 7x 157 BG
 5x 157 TC
 10x 157 CG
 5x 157 TC

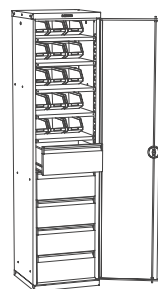

Ref. **157 9**
 54,5 Kg
 5x 157 BG
 15x 157 CP
 5x 157 TC
 5x 157 T50 C200

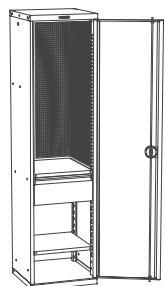

Ref. **157 10**
 65,2 Kg
 1x 157 PPF
 2x 159 PPL
 2x 157 BG
 1x 157 T50 C200

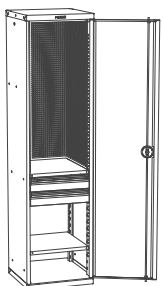

Ref. **157 11**
 67 Kg
 1x 157 PPF
 2x 159 PPL
 2x 157 BG
 2x 157 T50 C100

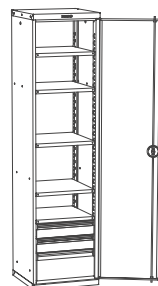

Ref. **157 12**
 62,5 Kg
 5x 157 BG
 2x 157 T50 C100
 1x 157 T50 C200

Ref. 157 C

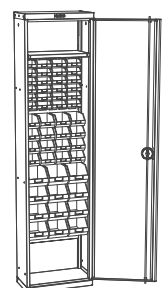

Ref. **157 C 1**
 48,58 Kg
 24x V-BULL 1
 16x V-BULL 2
 12x V-BULL 3
 Incluye estantería remachada
 Comprend une étagère rivetée
 Including riveted shelving

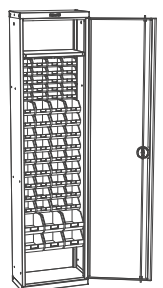

Ref. **157 C 2**
 46,24 Kg
 20x V-BULL 1
 36x V-BULL 2
 6x V-BULL 3
 Incluye estantería remachada
 Comprend une étagère rivetée
 Including riveted shelving

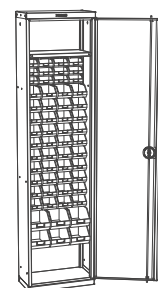

Ref. **157 C 3**
 46,31 Kg
 12x V-BULL 1
 40x V-BULL 2
 6x V-BULL 3
 Incluye estantería remachada
 Comprend une étagère rivetée
 Including riveted shelving

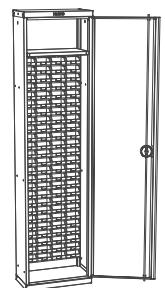

Ref. **157 C 4**
 44,60 Kg
 100x V-BULL 1
 Incluye estantería remachada
 Comprend une étagère rivetée
 Including riveted shelving

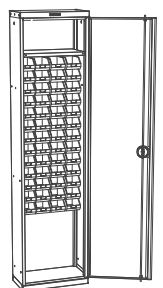

Ref. **157 C 5**
 45,72 Kg
 52x V-BULL 2
 Incluye estantería remachada
 Comprend une étagère rivetée
 Including riveted shelving

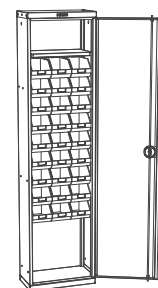

Ref. **157 C 6**
 46,10 Kg
 27x V-BULL 3
 Incluye estantería remachada
 Comprend une étagère rivetée
 Including riveted shelving

SERIE 158

SERIE 158

Armario 2 puertas
Armoire 2 portes
Cabinet with 2 doors

KG 52 Kg
mm 750 x 750 x 2130 mm

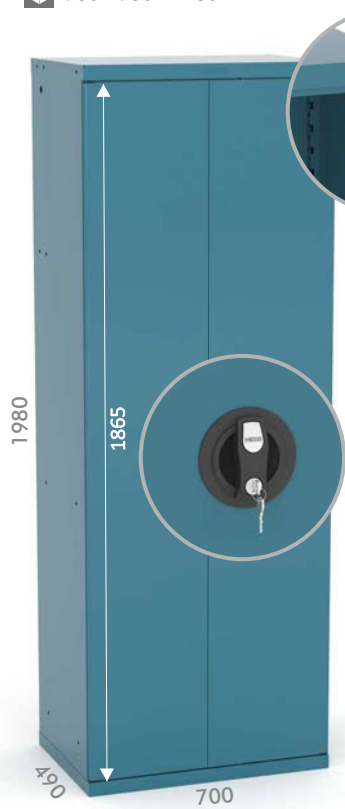

Apertura 180°.
Ouverture 180°.
Opening 180°.

Cierre con llave.
Fermeture à clé.
Key Locking.

Accesorios opcionales
Accessoires optionnels
Optional accessories

Ref. CE P 1

KG Cierre electrónico
Verrou électronique
Electronic Locking

REF. CE P 1
REF. CE P 1 TM
REF. CE P 1 TU



i Estanterías graduables cada 25mm.
Étagères réglables chaque 25mm.
Adjustable shelves every 25mm.

i Opción puertas de metacrilato.
Option portes de méthacrylate.
Methacrylate doors option.

Ref. 158 C

Armario con soportes para cubetas V-BULL 1, 2, 3
Armoire avec supports pour bacs à bec V-BULL 1, 2, 3
Cabinet with V-BULL 1, 2, 3 tray supports.

KG 50 Kg
mm 750 x 550 x 2130 mm
KG CAP. MAX. 300 Kg



Ref. V-BULL 1

KG 0,046 kg **mm** 0,4 l



Ref. V-BULL 2

KG 0,110 kg **mm** 1,2 l



Ref. V-BULL 3

KG 0,226 kg **mm** 3,5 l



Información de opciones estándares en catálogo general en web.
Information sur les options standard dans le catalogue général sur le web.
Information of standard options in the general catalog on web.

Ref. 158 BG

KG 2,5 Kg
mm 1 mm

bandeja
plateau
tray



Ref. 158 BG P

KG 3 Kg
mm 1 mm

bandeja para carpetas no incluidas
plateau pour dossiers non compris
tray for folders not included

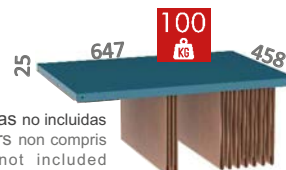

Ref. 158 T50 BE

KG 4 Kg
mm 0,8 mm

bandeja extraíble
plateau coulissant
removable tray



Ref. 158 S M

KG 1200
mm 700mm width, 490mm depth, 140mm height, 180mm depth



Ref. 157 CP

KG 0,5 Kg
l 4,92 l



Ref. 158 PV

mm 0,6 mm



Ref. 157 CG

KG 0,75 Kg
l 7,56 l



Ref. 158 PC 40

KG 7,5 Kg
mm 2 mm

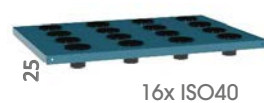

Ref. 158 PC 50

KG 7 Kg
mm 2 mm



Ref. 158 TI

KG 5,91 Kg
mm 1 mm

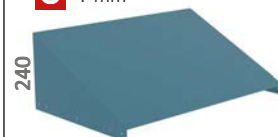

Ref. 158 TC

KG 0,53 Kg
mm 1,5 mm



Ref. 158 T50 C100

KG 4 Kg
mm 0,8 mm

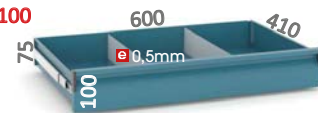

Ref. 158 T50 C200

KG 6 Kg
mm 0,8 mm

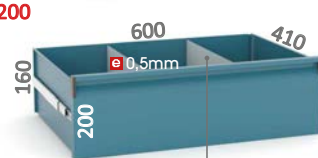

GT 50 **MAX** 6

separadores
séparateur
dividers

Ref. 158 PPF

KG 8,2 Kg
mm 1,2 mm

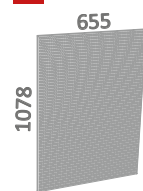

Ref. 159 PPL

KG 5,5 Kg
mm 1,2 mm



Ref. 156 P

H +80 mm
mm 2 mm



Ref. 158

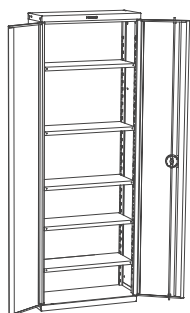

Ref. **158 1**
 64,5 Kg
 5x 158 BG

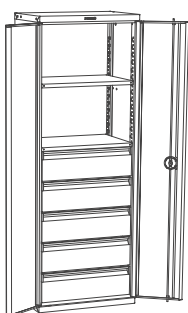

Ref. **158 2**
 87 Kg
 2x 158 BG
 5x 158 T50 C200

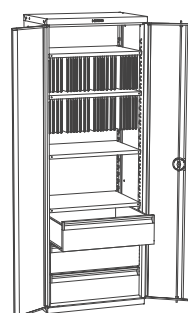

Ref. **158 3**
 83,5 Kg
 2x 158 BGP
 2x 158 BG
 3x 158 T50 C200

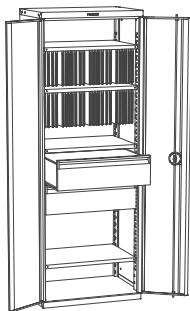

Ref. **158 4**
 75 Kg
 2x 158 BGP
 2x 158 BG
 2x 158 T50 C200

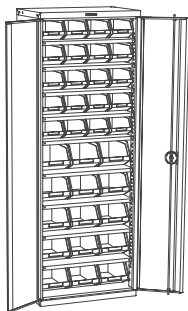

110
 110
 20x 157 CP 15x 157 CG
 Ref. **158 5**
 105 Kg
 9x 158 BG
 20x 157 CP
 15x 157 CG
 10x 157 TC

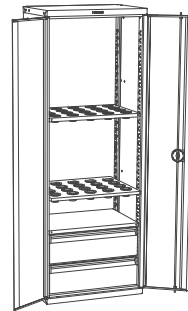

Ref. **158 6 1**
 81,5 Kg
 2x 158 PC 40
 1x 158 BG
 2x 158 T50 C200

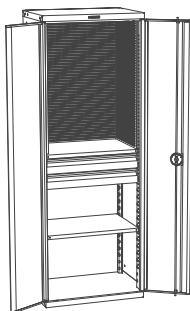

Ref. **158 7**
 83,2 Kg
 1x 158 PPF
 2x 159 PPL
 2x 158 BG
 2x 158 T50 C100

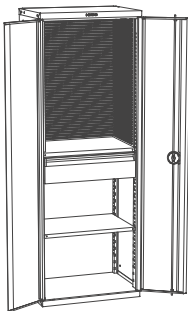

Ref. **158 8**
 81,2 Kg
 1x 158 PPF
 2x 159 PPL
 2x 158 BG
 1x 158 T50 C200

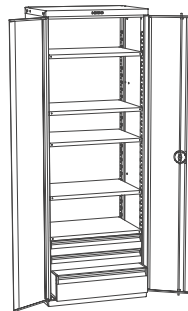

Ref. **158 9**
 78,5 Kg
 5x 158 BG
 2x 158 T50 C100
 1x 158 T50 C200

Ref. 158 C

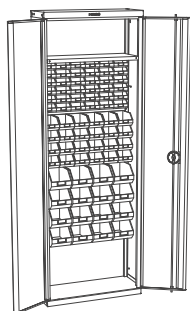

Ref. **158 C 1**
 57,91 Kg
 36x V-BULL 1
 24x V-BULL 2
 16x V-BULL 3
 Incluye estantería remachada
 Comprend une étagère rivetée
 Including riveted shelving

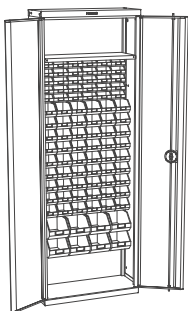

Ref. **158 C 2**
 59,13 Kg
 30x V-BULL 1
 54x V-BULL 2
 8x V-BULL 3
 Incluye estantería remachada
 Comprend une étagère rivetée
 Including riveted shelving

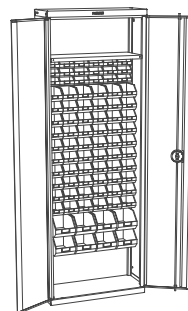

Ref. **158 C 3**
 59,24 Kg
 18x V-BULL 1
 60x V-BULL 2
 8x V-BULL 3
 Incluye estantería remachada
 Comprend une étagère rivetée
 Including riveted shelving

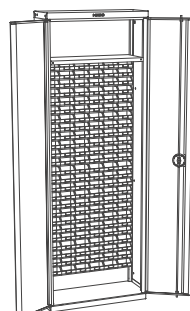

Ref. **158 C 4**
 56,90 Kg
 150x V-BULL 1
 Incluye estantería remachada
 Comprend une étagère rivetée
 Including riveted shelving

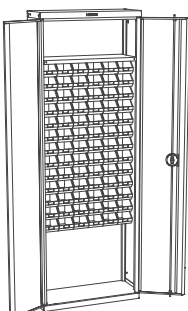

Ref. **158 C 5**
 58,58 Kg
 78x V-BULL 2
 Incluye estantería remachada
 Comprend une étagère rivetée
 Including riveted shelving

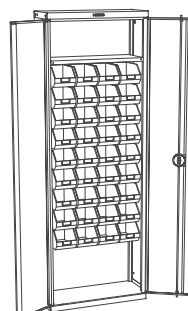

Ref. **158 C 6**
 58,14 Kg
 36x V-BULL 3
 Incluye estantería remachada
 Comprend une étagère rivetée
 Including riveted shelving

SERIE 159

SERIE 159

Armario 2 puertas
Armoire 2 portes
Cabinet with 2 doors

65 Kg
 1200 x 800 x 2130 mm

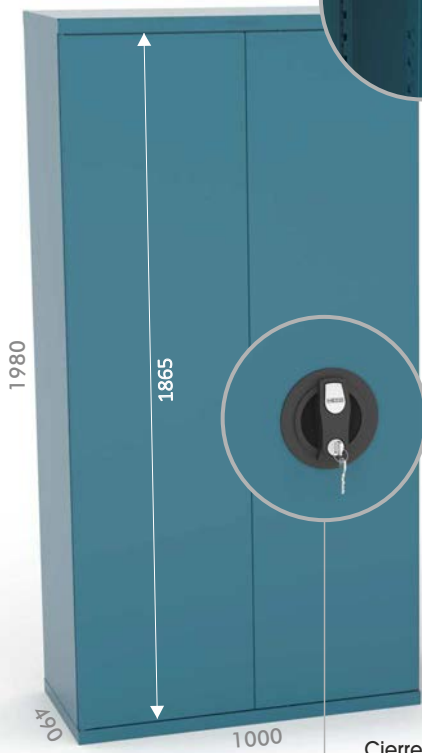

Apertura 180°.
Ouverture 180°.
Opening 180°.

Se suministra con goma lisa.
Livré avec revêtement caoutchouc lisse.
Supplied with smooth rubber.

3 mm



Cierre con llave.
Fermeture à clé.
Key Locking.

Ref. 159 C

Armario con soportes para cubetas V-BULL 1, 2, 3
Armoire avec supports pour bacs à bec V-BULL 1, 2, 3
Cabinet with V-BULL 1, 2, 3 tray supports.

70 Kg
 1200 x 800 x 2130 mm



Accesorios opcionales
Accessoires optionnels
Optional accessories

Ref. 157 BG

2 Kg
 0,8 mm
bandeja
plateau
tray



Ref. 159 BG

4,3 Kg
 1 mm
bandeja
plateau
tray



Ref. 159 BGP

4,5 Kg
 1 mm
bandeja para carpetas no incluidas
plateau pour dossiers non compris
tray for folders not included

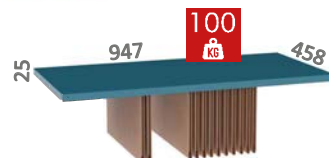

Ref. 159 T50 BE

6 Kg
 0,8 mm
bandeja extraíble
plateau coulissant
removable tray

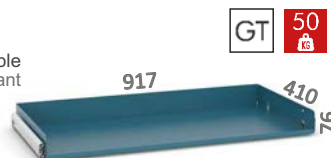

Ref. 159 PV - 159 B PV

12,48 Kg
 0,6 mm



Ref. 159 SC

9,73 Kg
 1 mm

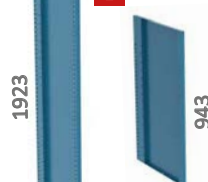

Ref. 159 B SC

5,39 Kg
 1 mm

Ref. 159 TI

7,06 Kg
 1 mm



Ref. 157 T50 C100

3,81 Kg
 0,8 mm



Ref. 157 T50 C200

5,5 Kg
 0,8 mm



159 DP 100

MAX 3 separadores
séparateur
dividers 50

Ref. 159 PPF

13 Kg
 1,2 mm

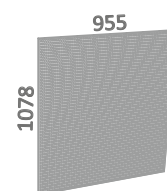

Ref. 159 PPL

5,5 Kg
 1,2 mm

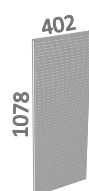

Ref. 156 P

H +80 mm
 2 mm



Ref. 159 B

Armario bajo 2 puertas
Armoire sous 2 portes
Cabinet low with 2 doors

38,19 Kg
 1200 x 800 x 1150 mm

Ref. V-BULL 1

0,046 kg 0,4 l



Ref. V-BULL 2

0,110 kg 1,2 l



Ref. V-BULL 3

0,226 kg 3,5 l



ancho 260 mm.
profundidad 260 mm.
width 260 mm.

Ref. 159 S M

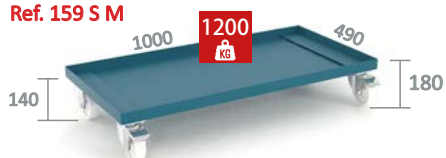

Ref. 159 TC

KG 0,76 Kg

e 1,5 mm



Ref. 157 CP

KG 0,5 Kg

e 4,92 l



Ref. 157 CG

KG 0,75 Kg

e 7,56 l



Ref. CE P 1

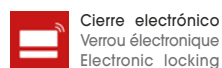

Cierre electrónico
Verrou électronique
Electronic locking



REF. CE P 1
REF. CE P 1 TM
REF. CE P 1 TU

Ref. 159 PC 40

KG 9 Kg

e 2 mm



24x ISO40

Ref. 159 PC 50

KG 8,5 Kg

e 2 mm



18x ISO50

Ref. 159 T50 C100

KG 6,5 Kg

e 0,8 mm

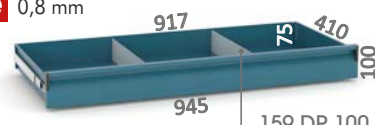

159 DP 100

Separador
Séparateur / Divider

Ref. 159 T50 C150

KG 7,5 Kg

e 0,8 mm

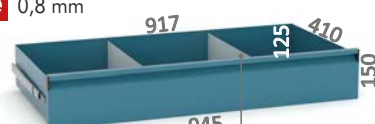

159 DP 150

Separador
Séparateur / Divider

Ref. 159 T50 C200

KG 7,95 Kg

e 0,8 mm



159 DP 200

Separador
Séparateur / Divider

Ref. 159 P

Armario con persiana, dos asas.
Armoire avec rideau, deux poignées.
Shutter closure cabinet, two handles.

KG 88,17 Kg

e 1200 x 800 x 2130 mm



Cierre con llave 1 punto, metal cromado (2 llaves).
Fermeture à clé 1 point, métal chromé (2 clés).
1 point key Locking, chrome metal (2 keys).

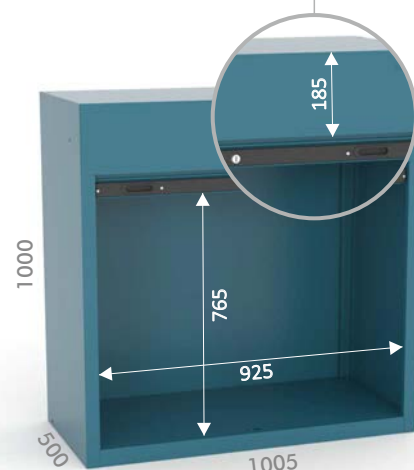

Ref. 159 P B

Armario con persiana
Armoire avec rideau
Shutter closure cabinet

KG 49,4 Kg

e 1200 x 800 x 1150 mm

Accesorios opcionales
Accessoires optionnels
Optional accessories

Ref. 157 CP

KG 0,5 Kg

e 4,92 l



Ref. 157 CG

KG 0,75 Kg

e 7,56 l

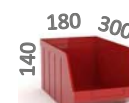

Ref. 159 TC

KG 0,8 Kg

e 1,5 mm



Ref. 159 P PPF

KG 9,9 Kg

e 1,2 mm

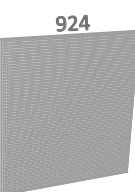

Ref. 159 P PPL

KG 5,5 Kg

e 1,2 mm



Ref. 159 P BG

KG 4,7 Kg

e 1 mm bandeja
plateau tray



Ref. 159 P PC 40

KG 9 Kg

e 2 mm

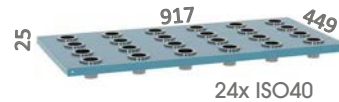

24x ISO40

Ref. 159 P PC 50

KG 8,5 Kg

e 2 mm



18x ISO50

Ref. 159 P T50 C100

KG 7 Kg

e 0,8 mm

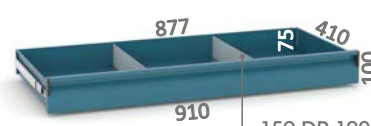

159 DP 100

Separador
Séparateur / Divider

Ref. 159 P T50 C200

KG 8,5 Kg

e 0,8 mm





159 DP 200

GT **50** **MAX 8** separadores
séparateur dividers

Información de opciones estándares en catálogo general en web.
Information sur les options standard dans le catalogue général sur le web.
Information of standard options in the general catalog on web.

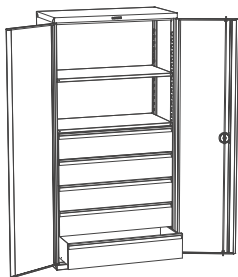
SERIE 159



Ref. **159 1**
 113,5 Kg
 5x 159 T50 C200
 2x 159 BG

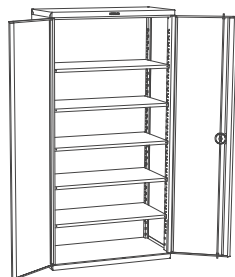

Ref. **159 2**
 87,5 Kg
 5x 159 BG

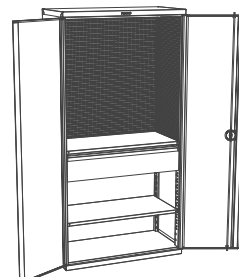

Ref. **159 3**
 98,5 Kg
 2x 159 BG
 1x 159 T50 C200
 2x 159 PPL
 1x 159 PPF

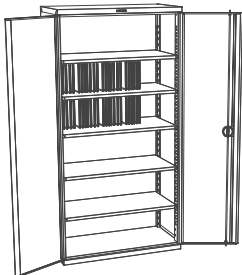

Ref. **159 4**
 83 Kg
 3x 159 BG
 2x 159 BGP

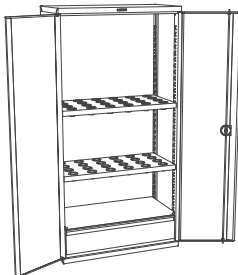

Ref. **159 5 1**
 94,5 Kg
 1x 159 T50 C200
 1x 159 BG
 2x 159 PC40

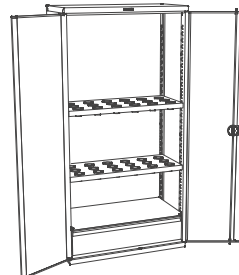

Ref. **159 5 1 5**
 94,5 Kg
 1x 159 T50 C200
 1x 159 BG
 2x 159 PC50
 1x 159 PPF

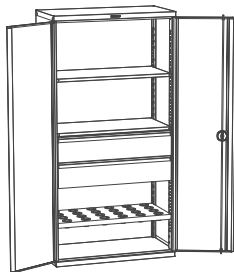

Ref. **159 6 1**
 96,5 Kg
 2x 159 T50 C200
 2x 159 BG
 1x 159 PC40

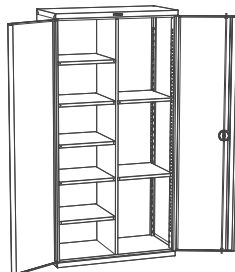

Ref. **159 7**
 92,5 Kg
 7x 157 BG
 1x 159 SC

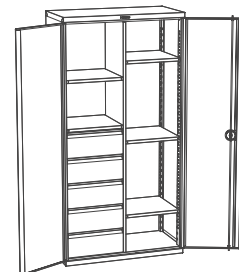

Ref. **159 8**
 120,5 Kg
 5x 157 T50 C200
 5x 157 BG
 1x 159 SC

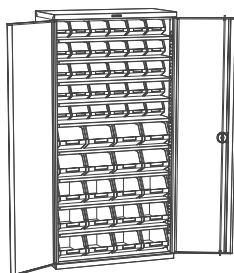

Ref. **159 9**
 122 Kg
 9x 159 BG
 30x 157 CP
 20x 157 CG
 10x 157 TC

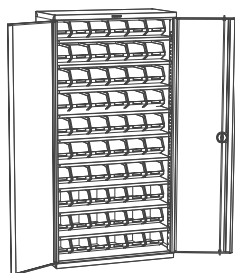

Ref. **159 9 CP**
 129,60 Kg
 9x 159 BG
 60x 157 CP
 10x 159 TC

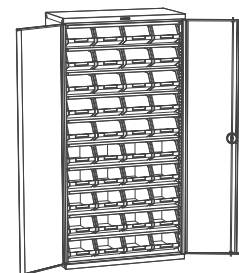

Ref. **159 9 CG**
 129,6 Kg
 2x 159 BG
 40x 157 CG
 10x 159 TC

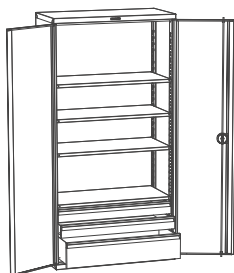

Ref. **159 10**
 95,5 Kg
 4x 159 BG
 2x 159 T50 C100
 1x 159 T50 C200

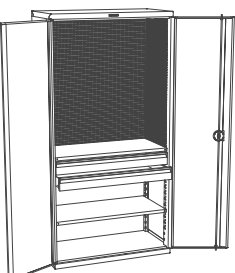

Ref. **159 11**
 106 Kg
 2x 159 BG
 2x 159 T50 C100
 2x 159 PPL
 1x 159 PPF



Ref. **159 12**
 118 Kg
 2x 159 BG
 2x 159 T50 C100
 4x 159 T50 C200

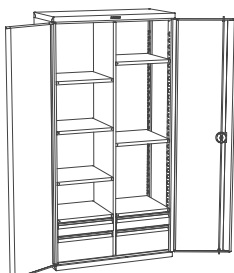

Ref. **159 13**
 110,5 Kg
 7x 157 BG
 2x 157 T50 C100
 2x 157 T50 C200
 1x 159 SC

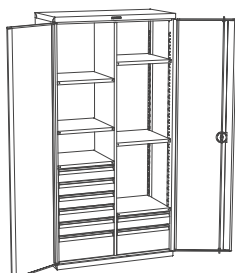

Ref. **159 14**
 122,5 Kg
 6x 157 BG
 6x 157 T50 C100
 2x 157 T50 C200
 1x 159 SC

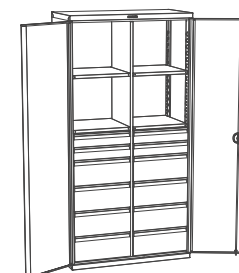

Ref. **159 15**
 144,5 Kg
 4x 157 BG
 4x 157 T50 C100
 8x 157 T50 C200
 1x 159 SC

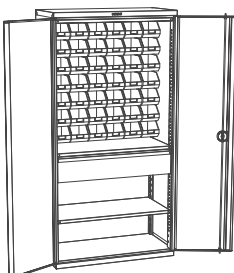

Ref. **159 16**
 110 Kg
 42x V-BULL 3
 1x 159 T50 C200
 2x 159 BG

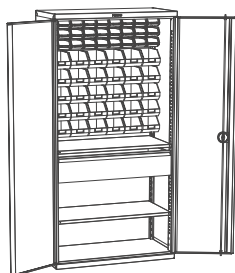

Ref. **159 17**
 110 Kg
 27x V-BULL 2
 30x V-BULL 3
 1x 159 T50 C200
 2x 159 BG

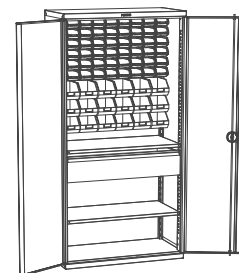

Ref. **159 18**
 110 Kg
 54x V-BULL 2
 18x V-BULL 3
 1x 159 T50 C200
 2x 159 BG

SERIE 159 C

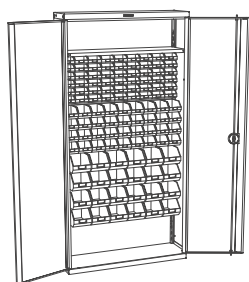
Ref. **159 C 1**

81,37 Kg
 54x V-BULL 1
 36x V-BULL 2
 24x V-BULL 3

Incluye estantería remachada
 Comprend une étagère rivetée
 Including riveted shelving

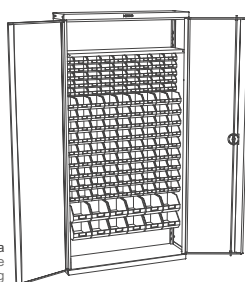
Ref. **159 C 2**

83,69 Kg
 45x V-BULL 1
 81x V-BULL 2
 12x V-BULL 3

Incluye estantería remachada
 Comprend une étagère rivetée
 Including riveted shelving

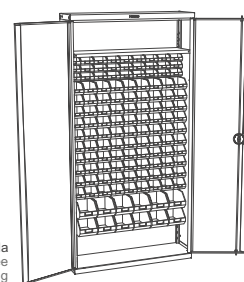
Ref. **159 C 3**

83,85 Kg
 27x V-BULL 1
 90x V-BULL 2
 12x V-BULL 3

Incluye estantería remachada
 Comprend une étagère rivetée
 Including riveted shelving

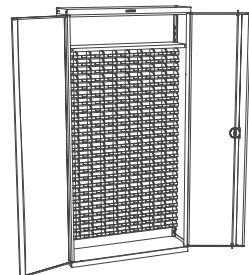
Ref. **159 C 4**

80,35 Kg
 225x V-BULL 1

Incluye estantería remachada
 Comprend une étagère rivetée
 Including riveted shelving

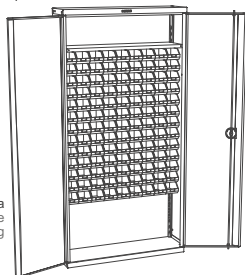
Ref. **159 C 5**

82,87 Kg
 117x V-BULL 2

Incluye estantería remachada
 Comprend une étagère rivetée
 Including riveted shelving

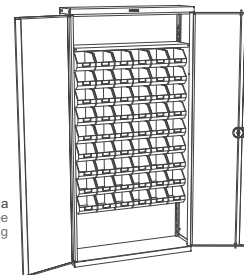
Ref. **159 C 6**

82,20 Kg
 54x V-BULL 3

Incluye estantería remachada
 Comprend une étagère rivetée
 Including riveted shelving

SERIE 159 B

Ref. **159 B 1**

41,5 Kg
 2x 159 BG

Ref. **159 B 2**

55,5 Kg
 1x 159 BG
 2x 159 T50 C200

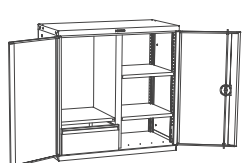
Ref. **159 B 3**

51,5 Kg
 3x 159 BG
 1x 159 B SC
 1x 157 T50 C200

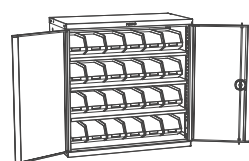
Ref. **159 B 4**

53,5 Kg
 3x 159 BG
 24x 157 CP

Ref. **159 B 5**

63 Kg
 2x 159 BG
 2x 159 T50 C100
 1x 159 T50 C200

Ref. **159 B 6**

48 Kg
 2x 159 BG
 1x 159 T50 C100

Ref. **159 B 7**

73 Kg
 4x 157 BG
 1x 159 B SC
 4x 157 T50 C100
 2x 157 T50 C200

Ref. **159 B 8**

71,5 Kg
 4x 157 BG
 1x 159 B SC
 2x 157 T50 C100
 3x 157 T50 C200

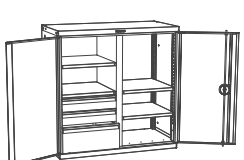
Ref. **159 B 9**

60,5 Kg
 4x 157 BG
 1x 159 B SC
 2x 157 T50 C100
 1x 157 T50 C200

SERIE 159 P

Ref. **159 P 1**

116 Kg
 2x 159 P BG
 5x 159 P T50 C200

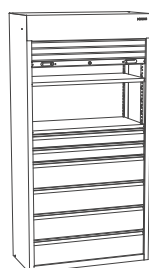
Ref. **159 P 2**

119 Kg
 2x 159 P BG
 2x 159 P T50 C100
 4x 159 P T50 C200

Ref. **159 P 3**

101 Kg
 5x 159 P BG

Ref. **159 P 4**

111 Kg
 4x 159 P BG
 2x 159 P T50 C100
 1x 159 P T50 C200

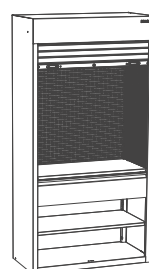
Ref. **159 P 5**

114 Kg
 2x 159 P BG
 1x 159 P PPF
 2x 159 P PPL
 1x 159 P T50 C200

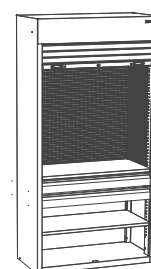
Ref. **159 P 6**

112 Kg
 2x 159 P BG
 1x 159 P PPF
 2x 159 P PPL
 2x 159 P T50 C100

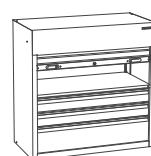
Ref. **159 P B 1**

67 Kg
 1x 159 P BG
 2x 159 P T50 C100
 1x 159 P T50 C200

Ref. **159 P B 2**

64 Kg
 1x 159 P BG
 2x 159 P T50 C200

Ref. **159 P B 3**

52 Kg
 1x 159 P BG

SERIE 159 F6

SERIE 159 F6

Armario 2 puertas fondo 600mm.
Armoire 2 portes profondeur 600mm.
Cabinet with 2 doors depth 600mm.

75 Kg 1200 x 800 x 2130 mm

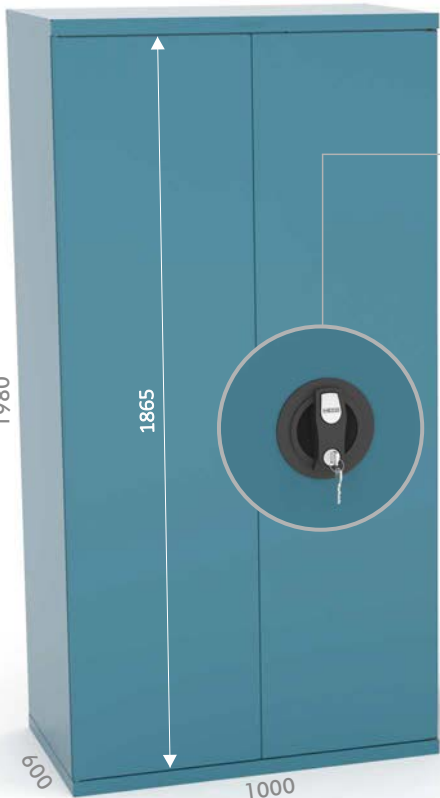

Cierre con llave.
Fermeture à clé.
Key Locking.



Ref. 159 F6 B

Armario bajo 2 puertas
Armoire sous 2 portes
Cabinet low with 2 doors

38,1 Kg
 1200 x 800 x 1150 mm

Gama de producto
Gamme de produit
Product range



Ref. 159 2 F6

5x 159 F6 BG
 92,75 Kg

Accesorios opcionales
Accessoires optionnels
Optional accessories

Ref. 159 F6 BG

5,23 Kg
 1 mm
bandeja
plateau
tray

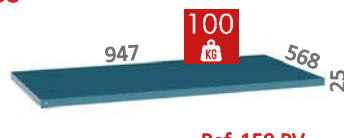

Ref. 159 PPF

12 Kg
 1,2 mm

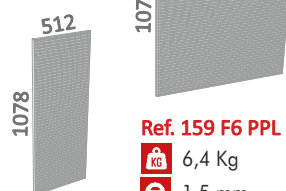

Ref. 159 F6 PPL

6,4 Kg
 1,5 mm

Ref. 159 PV

0,6 mm



Ref. 159 F6 T50 C100

8,4 Kg
 0,8 mm

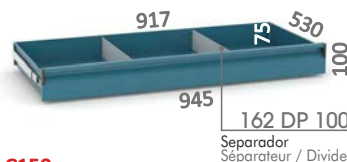

162 DP 100
Separador
Séparateur / Divider

Ref. 159 F6 T50 C150

9,7 Kg
 0,8 mm

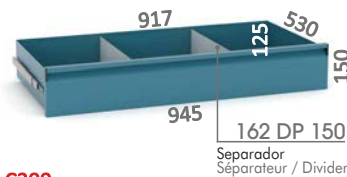

162 DP 150
Separador
Séparateur / Divider

Ref. 159 F6 T50 C200

11 Kg
 0,8 mm

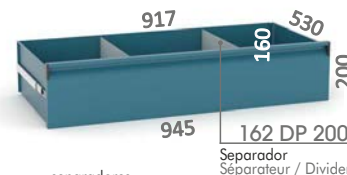

162 DP 200
Separador
Séparateur / Divider

50 MAX 8 separadores
séparateur
dividers

Ref. 159 F6 S M



Ref. 159 F6 TI

8,68 Kg
 1 mm

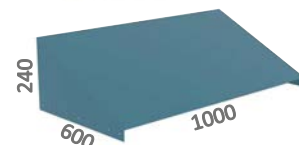

Ref. 159 TC

0,76 Kg
 1,5 mm

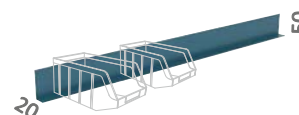

Ref. 157 CP

0,5 Kg
 4,92 l



Ref. 157 CG

0,75 Kg
 7,56 l



Ref. CE P 1

Cierre electrónico
Verrou électronique
Electronic locking



REF. CE P 1
REF. CE P 1 TM
REF. CE P 1 TU

SERIE 159 CA

Armarios esquineros.
Armoires d'angle.
Corner cabinets.





Gama de producto
Gamme de produit
Product range



F 490

Armario esquinero 1 puerta F 490
Armoire cantonnière 1 porte F490
Corner cabinet with 1 door F490

Ref. 159 CA

-  70 Kg
-  100 Kg
-  1500 x 1000 x 2130 mm

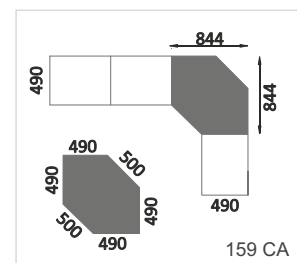

Ref. 159 B CA

-  44 Kg
-  71 Kg
-  1500 x 1000 x 1150 mm



**F 600**

Armario esquinero 1 puerta F 600
Armoire cantonnière 1 porte F 600
Corner cabinet with 1 door F 600

Ref. 159 CA F6

-  83 Kg
-  113 Kg
-  1500 x 1000 x 2130 mm

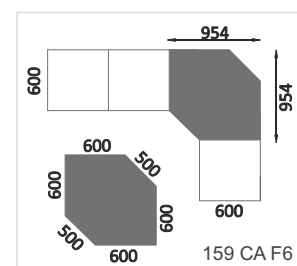

Ref. 159 B CA F6

-  52 Kg
-  79 Kg
-  1500 x 1000 x 1150 mm





Accesorios opcionales
Accessoires optionnels
Optional accessories

Ref. 159 CA B

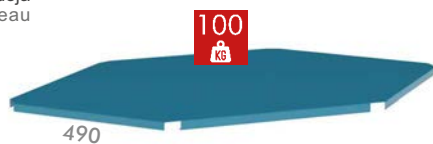
-  7,2 Kg bandeja plateau tray
-  e 1 mm

**Ref. 159 CA F6 B**

-  9,5 Kg bandeja plateau tray
-  e 1 mm

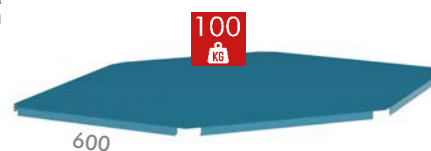

SERIE 162

SERIE 162

Armario 2 puertas ancho 1200mm.
Armoire 2 portes largeur 1200mm.
Cabinet with 2 doors width 1200mm.

 76,1 Kg  1200 x 800 x 2130 mm

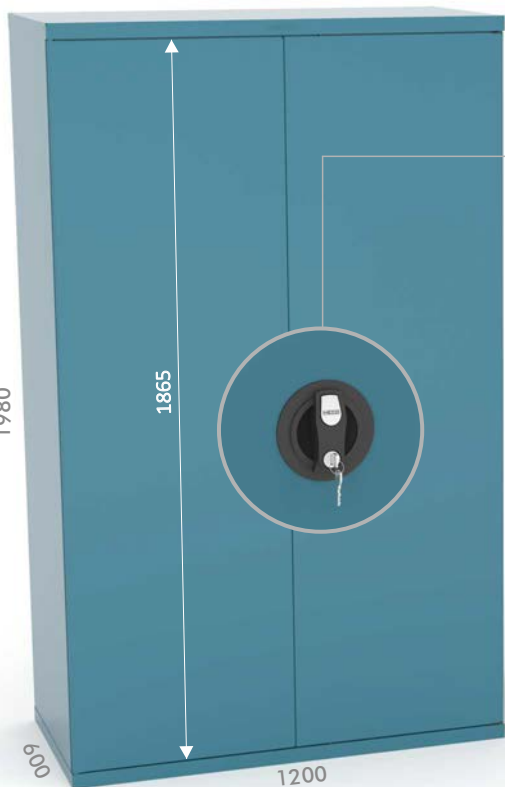



Cierre con llave.
Fermeture à clé.
Key Locking.



Ref. 162 B

Armario bajo 2 puertas
Armoire sous 2 portes
Cabinet low with 2 doors

 48,72 Kg
 1200 x 800 x 1150 mm

Gama de producto
Gamme de produit
Product range



Ref. 162 2

5x 162 BG

 107,8 Kg

Accesorios opcionales
Accessoires optionnels
Optional accessories

Ref. 162 BG

 6,25 Kg

 1 mm

bandeja
plateau
tray



Ref. 162 PV

 0,6 mm



Ref. 159 F6 PPL

 6,4 Kg

 1,2 mm

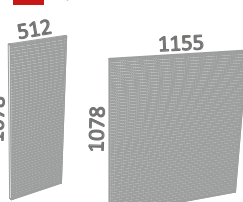

Ref. 162 PPF

 15,56 Kg

 1,2 mm

Ref. 159 F6 S M



Ref. 157 CP

 0,5 Kg

 4,92 l



Ref. 157 CG

 0,75 Kg

 7,56 l



Ref. CE P 1

 Cierre electrónico
Verrou électronique
Electronic locking

 REF. CE P 1
REF. CE P 1 TM
REF. CE P 1 TU

Ref. 162 TI

 9,51 Kg

 1 mm



Ref. 162 T50 C100

 10,3 Kg

 0,8 mm



Ref. 162 T50 C150

 11,8 Kg

 0,8 mm



Ref. 162 T50 C200

 13,4 Kg

 0,8 mm

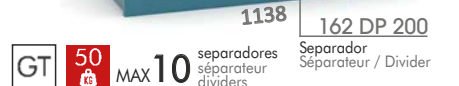

 50

 MAX 10

separadores
séparateurs
dividers

Separador
Séparateur / Divider

SERIE **162 PC**

Cierre con llave y tirador.
Serrure et clé et poignée.
Key locking and handle.

Ref. **162 PC**
Armario con puertas correderas
Armoire avec portes coulissantes
Cabinet with sliding doors

95 Kg
 1200 x 800 x 2130 mm



Ref. **162 PC B**
Armario bajo puertas correderas
Armoire sous portes coulissantes
Cabinet low sliding doors

63,82 Kg
 1200 x 800 x 1150 mm

Gama de producto
Gamme de produit
Product range

Accesorios opcionales
Accessoires optionnels
Optional accessories

Ref. **162 PC SC**

11,62 Kg
 1 mm

524

Ref. **162 PC B SC**

7,75 Kg
 1 mm

958

1938

Ref. **162 PC T50 C100**

5,64 Kg
 1 mm

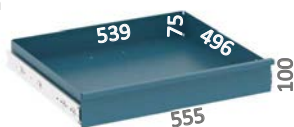

GT 50

Ref. **162 PC T50 C150**

6,43 Kg
 1 mm



Ref. **162 PC T50 C200**

7,26 Kg
 1 mm



Ref. **162 PC BG**

2,83 Kg
 1 mm



Ref. **162 PC 2**

1x 162 PC SC
10x 162 PC BG

134,95 Kg



Ref. **162 PC B 2**

1x 162 PC B SC
4x 162 PC BG

82,89 Kg



SERIE V-420

SERIE V-420

Armario para cubetas V-FOX
Armoire pour bacs à bec V-FOX
Cabinet for V-FOX trays

 63 Kg

 670 x 550 x 2130 mm

SERIE V-FOX

COLOR
COULEUR
COLOUR



No admite ruedas
Roues interdites
No wheels allowed

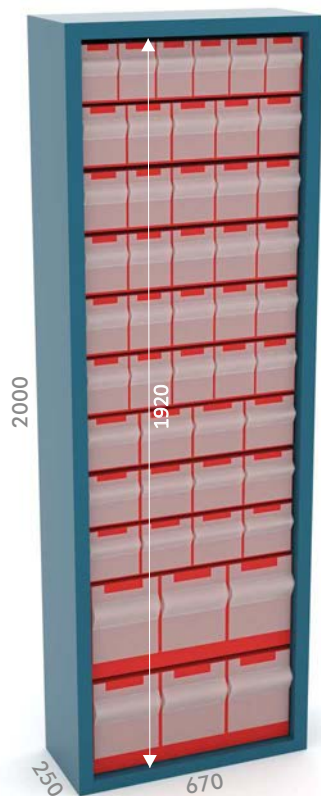

Ref. V-420 P

ACCESORIO Puerta Opaca
ACCESSOIRES Porte opaque
ACCESSORY Opaque Door



Ref. V-420 PV

ACCESORIO Puerta con Metacrilato
ACCESSOIRE Porte en Méthacrylate
ACCESSORY Methacrylate Door



Apertura de las puertas a 90°.
Ouverture des portes à 90°.
90° doors opening.

Gama de producto
Gamme de produit
Product range

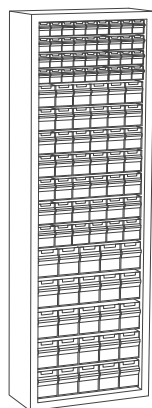

V-420 H 1

 61,66 Kg
4x V-FOX 101
7x V-FOX 102
5x V-FOX 103

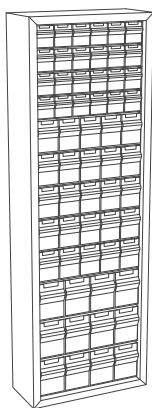

V-420 H 2

 64,22 Kg
4x V-FOX 102
5x V-FOX 103
3x V-FOX 104

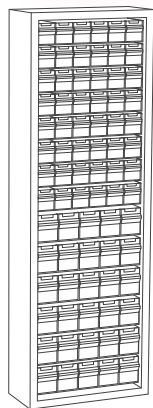

V-420 H 3

 60,04 Kg
8x V-FOX 102
6x V-FOX 103

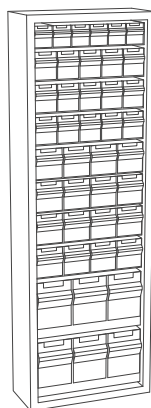

V-420 H 4

 67,18 Kg
1x V-FOX 102
3x V-FOX 103
4x V-FOX 104
2x V-FOX 105

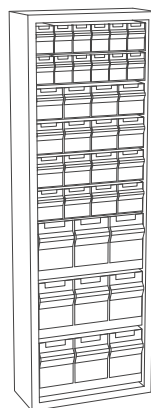

V-420 H 5

 67,8 Kg
2x V-FOX 103
4x V-FOX 104
3x V-FOX 105

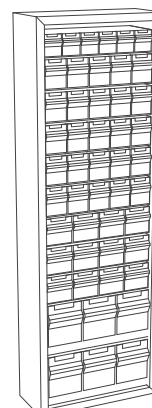

V-420 H 6

 68,18 Kg
1x V-FOX 102
5x V-FOX 103
3x V-FOX 104
2x V-FOX 105



Accesorios opcionales
Accessoires optionnels
Optional accessories

Ref. V-FOX 101

 0,12 l
 0,65 Kg
9 CUBETAS
BACS A BEC
TRAYS



Ref. V-FOX 102

 0,42 l
 1,08 Kg
6 CUBETAS
BACS A BEC
TRAYS



Ref. V-FOX 103

 1,2 l
 1,90 Kg
5 CUBETAS
BACS A BEC
TRAYS



Ref. V-FOX 104

 2,4 l
 2,8 Kg
4 CUBETAS
BACS A BEC
TRAYS



Ref. V-FOX 105

 4,5 l
 3,6 Kg
3 CUBETAS
BACS A BEC
TRAYS

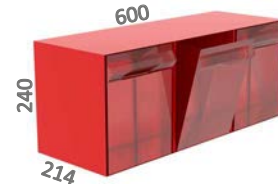

Ref. V-FOX 101 V
VARILLA DE SEGURIDAD
TRINGLE DE SECURITÉ
SAFETY BAR

Ref. V-FOX 102 V
VARILLA DE SEGURIDAD
TRINGLE DE SECURITÉ
SAFETY BAR

Ref. V-FOX 103 V
VARILLA DE SEGURIDAD
TRINGLE DE SECURITÉ
SAFETY BAR

Ref. V-FOX 104 V
VARILLA DE SEGURIDAD
TRINGLE DE SECURITÉ
SAFETY BAR

Ref. V-FOX 105 V
VARILLA DE SEGURIDAD
TRINGLE DE SECURITÉ
SAFETY BAR

SERIE V-ABULL

SERIE V-ABULL

Armario para cubetas V-ABULL
Armoire pour bacs à bec V-ABULL
Cabinet for V-ABULL trays

 64,5 Kg

 1200 x 800 x 1900-1950 mm

SERIE V-BULL

COLOR
COLEUR
COLOUR

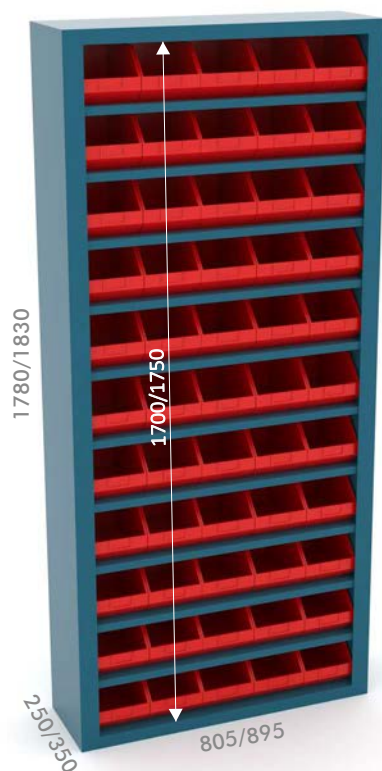

No admite ruedas
Roues interdites
No wheels allowed



Capacidad de carga por bandeja
Capacité de charge par plateau
Loading capacity per tray

Gama de producto
Gamme de produit
Product range

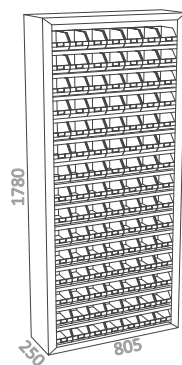

 V-ABULL 2
7u. estante
x15 filas
105 cubetas

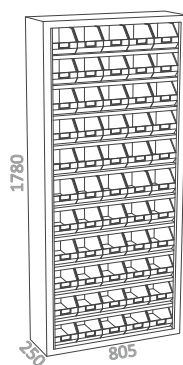

 V-ABULL 3
5u. estante
x11 filas
55 cubetas

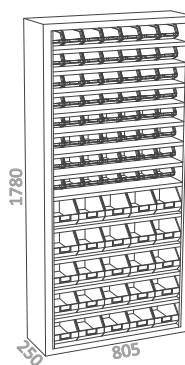

 V-ABULL 2
7u. estante
x 8 filas
56 cubetas

 V-ABULL 3
5u. estante
x 5 filas
25 cubetas

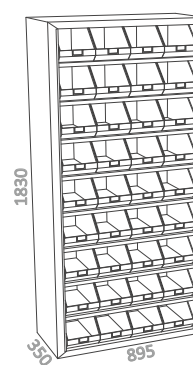

 V-ABULL 4
4u. estante
x 9 filas
36 cubetas

V-ABULL 2

 76 Kg
14x V-ABULL B
105x V-BULL 2

V-ABULL 3

 64 Kg
10x V-ABULL B
55x V-BULL 3

V-ABULL 2 3

 70 Kg
12x V-ABULL B
56x V-BULL 2
25x V-BULL 3

V-ABULL 4

 85 Kg
8x V-ABULL B
36x V-BULL 4

Accesorios opcionales
Accessoires optionnels
Optional accessories

Ref. V-BULL 1

 0,4 l
 0,046 Kg



Ref. V-BULL 2

 1,2 l
 0,110 Kg



Ref. V-BULL 3

 3,5 l
 0,226 Kg



Ref. V-BULL 4

 9,1 l
 0,638 Kg

