

SERIE 103



SERIE 104



SERIE 103



accesorios  
accessoires  
accessories

KIT ELECTRICIDAD INCLUIDO  
KIT ÉLECTRICITÉ INCLUS  
INCLUDED POWER KIT

■ RAL 7016



RUEDAS ROUES WHEELS



PIES PIEDS STANDS

Base redonda regulable en altura.  
Base ronde réglable en hauteur.  
Height-adjustable round base.



4 tomas 220V + ventilador + magnetotérmico + entrada de corriente  
4 prises 220V + ventilateur + magnéto thermique + prise de courant  
4 220V plugs + fan + thermal magneto + input power



El material informático de las imágenes no se suministra.  
Le matériel informatique pour les images n'est pas fourni.  
The computer equipment for the images is not supplied.



Los pies y las ruedas, se suministran sin montar, en los modelos que las incluyen.  
Les pieds et les roulettes sont livrés non montés dans les modèles qui en sont équipés.  
The feet and wheels are supplied unassembled in the models that include them.



## información information information

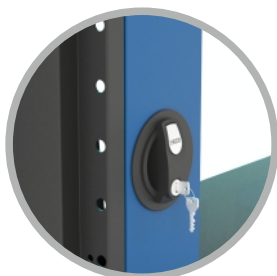

Cierres a dos puntos o a un solo punto, según conjunto.  
Serrures à deux points ou à un seul point, selon le réglage.  
Two-point or single-point locks, depending on the set.

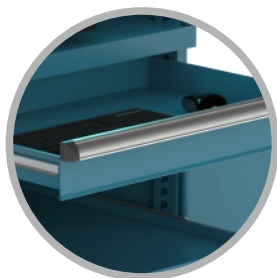
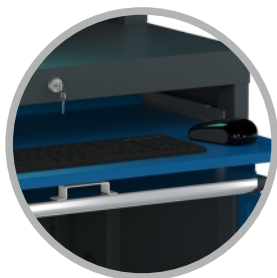

Cajones y bandejas para teclado y ratón, según serie.  
Tiroirs et étagères pour clavier et souris selon les séries.  
Drawers and trays for keyboard and mouse according to series.

- [ES]**
  - Armario modular para PC.
  - Para pantallas planas de hasta 26".
  - Configure su armario según sus necesidades.
  - Disponible con o sin ruedas.
  - Disponibilidad de servir sin Kit eléctrico.
  - Color estándar azul martelé (SERIE 105) y RAL 7016 - RAL 5010 (SERIE 103-104) posibilidad colores en opción.
  - Material informático no se suministra.

- [FR]**
  - Armoire modulaire pour PC.
  - Pour écrans plats jusqu'à 26".
  - Configurez votre armoire en fonction de vos besoins.
  - Disponible avec ou sans roues.
  - Possibilité de servir sans kit électrique.
  - Couleur standard bleu martelé (SÉRIE 105) et RAL 7016 - RAL 5010 (SÉRIE 103 - 104) possibilité teintes en option.
  - Matériel informatique non fournis.

- [EN]**
  - Modular cabinet for PC.
  - For flat screens up to 26".
  - Configure your cabinet according to your needs.
  - Available with or without wheels.
  - Availability to serve without electrical kit.
  - Standard colour hammered blue (SERIE 105) and RAL 7016 - RAL 5010 (SERIE 103 - 104) possibility optional colours.
  - Informatic material not supplied.

**SERIE 103**

**Ref. 103 1**

Armario Pantalla con puerta metacrilato.  
Armoire écran avec porte méthacrylate.  
Screen cabinet with methacrylate door.

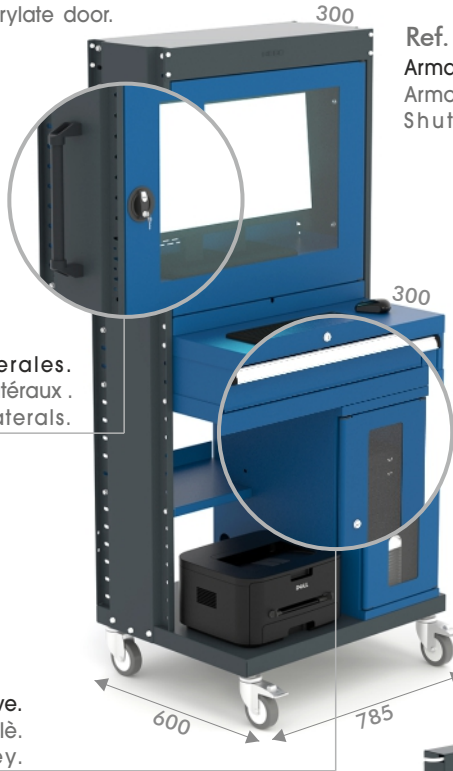

Con asas a ambos laterales.  
Avec poignées de chaque latéraux.  
With handles on both laterals.

**e** 1,5 mm

Cierre centralizado con llave.  
Verrouillage centralisé avec clé.  
Central locking with key.

**e** 0,6 mm

Armario PC configurable con puerta o persiana.  
Armoire PC configurable avec porte ou rideau.  
Configurable PC cabinet with door or shutter closure.

www

**Ref. 103 1 P**

Armario Pantalla con persiana.  
Armoire écran avec rideau.  
Shutter screen cabinet.

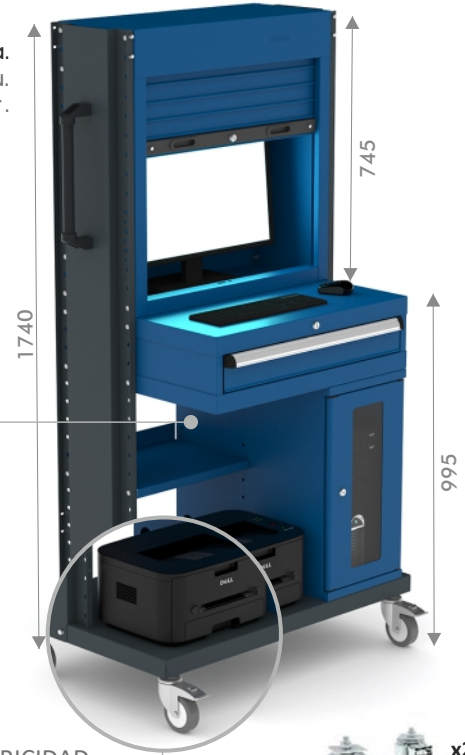

**100** **GS**

Apertura 90%.  
Ouverture 90%.  
90% opening.



**KIT ELECTRICIDAD**  
**KIT ÉLECTRICITÉ**  
**POWER KIT**

**RAL 7016**

Ruedas.  
Roues.  
Wheels. **x2**

ø 100 mm H 135 mm

**Gama de producto**  
**Gamme de produits**  
**Product range**

4 tomas 220V + ventilador + magnetotérmico + entrada de corriente  
4 prises 220V + ventilateur + magnéto thermique + prise de courant  
4 220V plugs + fan + thermal magneto + input power

800 x 650 x 1870 mm

**Ref. 103 1**

75 Kg

**KIT ELECTRICIDAD**  
**KIT ÉLECTRICITÉ**  
**POWER KIT**



**Ref. 103 2**

55 Kg

**KIT ELECTRICIDAD**  
**KIT ÉLECTRICITÉ**  
**POWER KIT**



**Ref. 103 3**

45 Kg



**Ref. 103 4**

33 Kg

**PIES**  
**PIEDS**  
**STANDS**



**Ref. 103 1 P**

60 Kg

**KIT ELECTRICIDAD**  
**KIT ÉLECTRICITÉ**  
**POWER KIT**



**Ref. 103 2 P**

60 Kg

**KIT ELECTRICIDAD**  
**KIT ÉLECTRICITÉ**  
**POWER KIT**



**COLORES**  
**COULEURS**  
**COLOURS**



**RAL 5010**  
**RAL 7016**



Equipo informático no incluido. Admiten monitores de hasta 26".  
Équipement informatique non inclus. Pour moniteurs jusqu'à 26".  
Computer equipment not included. Monitors up to 26" are supported.



**KIT ELECTRICIDAD INCLUIDO**  
**KIT ÉLECTRICITÉ INCLUS**  
**INCLUDED POWER KIT**

**www** Armario PC opción con puerta o persiana.  
Armoire PC option avec porte ou rideau.  
PC cabinet with option door or shutter closure.

**Ref. 104 0**

Puerta de metacrilato.  
Porte de méthacrylate.  
Methacrylate door.

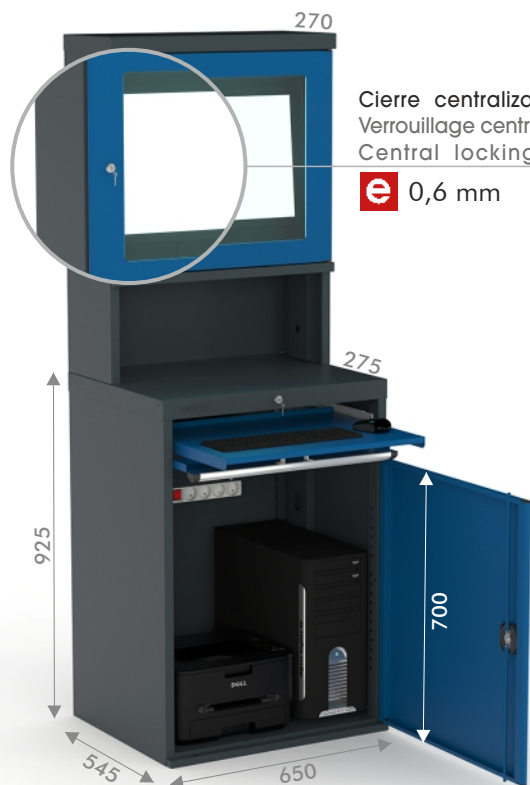

Cierre centralizado con llave en puertas.  
Verrouillage centralisé avec clé dans les portes.  
Central locking with key in the doors.

**e** 0,6 mm

**Ref. 104 1**

Persiana y bandeja extraíble.  
Rideau et plateau amovible.  
Shutter closure and removable tray.

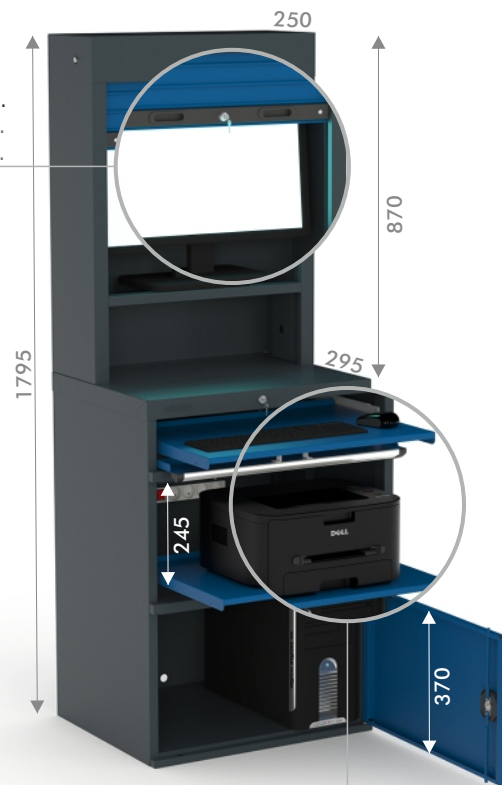

Bandeja extensible y cajón.  
Plateau amovible et tiroir.  
Removable tray and drawer.

**50**

**GT**

Apertura 100%.  
Ouverture 100%.  
100% opening.

Información adicional  
Information supplémentaire  
Additional information

750 x 750 x 1930 mm

FABRICACIÓN  
FABRICATION  
MANUFACTURING

Estructura metálica.  
Chassis métallique.  
Metallic frame.

**e** 1 mm

KIT ELECTRICIDAD INCLUIDO  
KIT ÉLECTRICITÉ INCLUS  
INCLUDED POWER KIT

RAL 7016



4 tomas 220V + ventilador + magnetotérmico + entrada de corriente  
4 prises 220V + ventilateur + magnéto thermique + prise de courant  
4 220V plugs + fan + thermal magneto + input power

P I E S  
PIEDS  
STANDS



Base redonda regulable en altura.  
Base ronde réglable en hauteur.  
Height-adjustable round base.

RUEDAS  
ROUES  
WHEELS



Ø100 mm  
H 135 mm

COLORES  
COULEURS  
COLOURS RAL 5010  
 RAL 7016



Equipo informático no incluido. Admiten monitores de hasta 26".  
Équipement informatique non inclus. Les moniteurs jusqu'à 26" sont pris en charge.  
Computer equipment not included. Monitors up to 26" are supported.

SERIE 104

Gama de producto  
Gamme de produits  
Product range

Ref. 104 0

**H 1800**

67,75 Kg

KIT ELECTRICIDAD  
KIT ELECTRICITE  
POWER KIT



Ref. 104 0 P

**H 1880**

68,25 Kg

KIT ELECTRICIDAD  
KIT ELECTRICITE  
POWER KIT

PIES  
PIEDS  
STANDS



Ref. 104 0 R

**H 1935**

69,75 Kg

KIT ELECTRICIDAD  
KIT ELECTRICITE  
POWER KIT

RUEDAS  
ROUES  
WHEELS



Ref. 104 1

**H 1800**

72 Kg

KIT ELECTRICIDAD  
KIT ELECTRICITE  
POWER KIT



Ref. 104 1 P

**H 1880**

72,5 Kg

KIT ELECTRICIDAD  
KIT ELECTRICITE  
POWER KIT

PIES  
PIEDS  
STANDS



Ref. 104 1 R

**H 1935**

74 Kg

KIT ELECTRICIDAD  
KIT ELECTRICITE  
POWER KIT

RUEDAS  
ROUES  
WHEELS



Ref. 104 0 1

Ref. 104 0 1

**H 1800**

76,1 Kg

KIT ELECTRICIDAD  
KIT ELECTRICITE  
POWER KIT



Ref. 104 0 1 P

**H 1880**

76,6 Kg

KIT ELECTRICIDAD  
KIT ELECTRICITE  
POWER KIT

PIES  
PIEDS  
STANDS



Ref. 104 0 1 R

**H 1935**

78,1 Kg

KIT ELECTRICIDAD  
KIT ELECTRICITE  
POWER KIT

RUEDAS  
ROUES  
WHEELS



Ref. 104 1 0

Ref. 104 1 0

**H 1800**

70 Kg

KIT ELECTRICIDAD  
KIT ELECTRICITE  
POWER KIT



Ref. 104 1 0 P

**H 1880**

70,5 Kg

KIT ELECTRICIDAD  
KIT ELECTRICITE  
POWER KIT

PIES  
PIEDS  
STANDS



Ref. 104 1 0 R

**H 1935**

72 Kg

KIT ELECTRICIDAD  
KIT ELECTRICITE  
POWER KIT

RUEDAS  
ROUES  
WHEELS



SERIE 105

Armario PC con puertas.  
Armoire PC avec portes.  
PC cabinet with doors.

WWW

Ref. 105 1

Bandejas graduables cada 25 mm.  
Étagères réglables chaque 25 mm.  
Adjustable shelves every 25 mm.



Cierre centralizado con llave en puertas.  
Verrouillage centralisé avec clé dans les portes.  
Central locking with key in the doors.

**e** 0,6 mm

Ref. 105 2

Bandejas extraíbles.  
Plateaux amovibles.  
Removable trays.

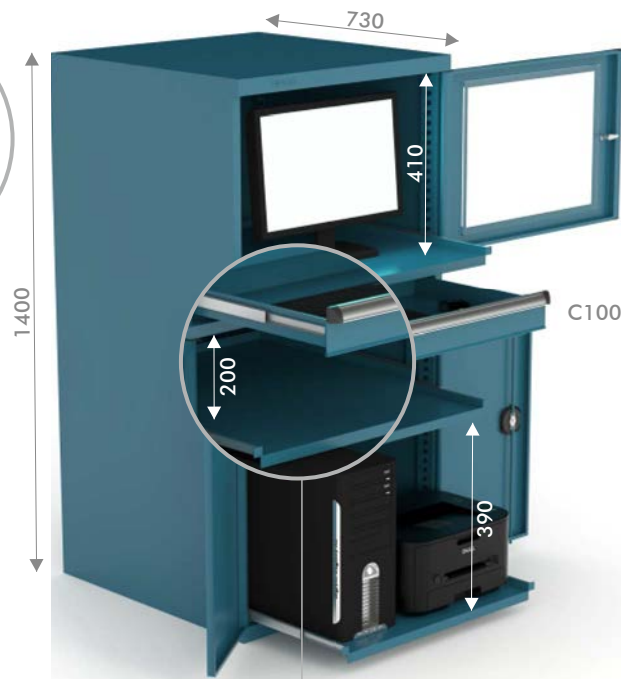

Bandeja extensible y cajón.  
Plateau amovible et tiroir.  
Removable tray and drawer.

50  
KB

GT

Apertura 100%.  
Ouverture 100%.  
100% opening.

Gama de producto  
Gamme de produits  
Product range

750 x 750 x 1600 mm

Ref. 105 1

72 Kg

Ref. 105 2

102 Kg

H 1400

KIT ELECTRICIDAD  
KIT ÉLECTRICITÉ  
POWER KIT



Ref. 105 1 Z

80 Kg

Ref. 105 2 Z

110 Kg

H 1450

ZÓCALO  
SOCLE  
PLINTH  
 KIT ELECTRICIDAD  
KIT ÉLECTRICITÉ  
POWER KIT



Ref. 105 1 R

95 Kg

Ref. 105 2 R

125 Kg

H 1535

RUEDAS  
ROUES  
WHEELS  
 KIT ELECTRICIDAD  
KIT ÉLECTRICITÉ  
POWER KIT



COLOR  
COULEUR  
COLOUR

AZUL  
MARTELÉ



Para otros colores hay un coste adicional.  
Pour d'autres couleurs il y a un coût additionnel.  
For others colours there is an additional cost.



Equipo informático no incluido.  
Équipement informatique non inclus.  
Computer equipment not included.



KIT ELECTRICIDAD INCLUIDO  
KIT ÉLECTRICITÉ INCLUS  
INCLUDED POWER KIT

RAL 7016



4 tomas 220V + ventilador + magnetotérmico + entrada de corriente  
4 prises 220V + ventilateur + magnéto thermique + prise de courant  
4 220V plugs + fan + thermal magneto + input power