

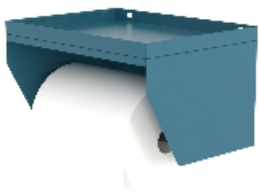

accesorios  
accessoires  
accessories

Ref. 149 0 01



Ref. 149 0 04



SERIE ISO 40/50



SERIE VDI 40

SERIE HSK 50/63/80/100



SERIE CAPTO 8

Ref. V-BULL 1

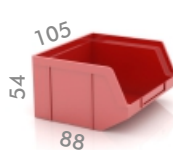

Ref. CE P 1

Ref. V-BULL 2

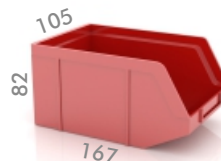

Ref. V-BULL 3



Cierre electrónico  
Verrou électronique  
Electronic locking



información  
information  
information

- [ES]**
  - Carros de trabajo y de taller.
  - Varias opciones de almacenaje, según necesidad.
  - Opción porta conos (ISO, CAPTO, VDI y HSK).
  - Ruedas de goma Ø75 - 100 mm (según modelo).
  - Carga máxima: 100 kg (excepto serie 134 > 240 Kg).
  - Panel perforado: chapa 1,5 mm.
  - Panel porta cubetas: chapa 1,2 mm.
  - Armazón: chapa 1 mm.
  - Asa en cada lateral para facilitar el transporte.
  - Color estándar azul martelé posibilidad colores en opción.
- [FR]**
  - Desserte de travail et servante d'atelier.
  - Plusieurs options de rangement selon besoin.
  - Option porte-cônes (ISO, CAPTO, VDI et HSK).
  - Roues en caoutchouc Ø75 - 100 mm (selon le modèle).
  - Charge maximale: 100 kg (sauf série 134 > 240 kg).
  - Panneaux perforés: épaisseur 15/10 mm.
  - Panneau bacs à bec: épaisseur 12/10 mm.
  - Châssis: Tôle 15/10 mm.
  - Double poignée laterale pour faciliter le transport.
  - Couleur standard bleu martelé possibilité teintes en option.
- [EN]**
  - Workshop trolleys with trays for storage.
  - Several storage options according to need.
  - Optional tool-holders (ISO, CAPTO, VDI and HSK).
  - Perforated panels: 1,5 mm metal sheet.
  - Tray-holder panels: 1,2 metal sheet.
  - Frame: 1 mm metal sheet.
  - Rubber wheels, Ø75 - 100 mm (depending on model).
  - Maximum load: 100kg (except serie 134 > 240kg).
  - Handle feach for easy transport.
  - Standard colour hammered blue possibility optional colours.



Cierre con llave.  
Fermeture à clé.  
Key Locking.



Interior cajón ranurado.  
Intérieur tiroir rainurée.  
Interior slotted drawer.

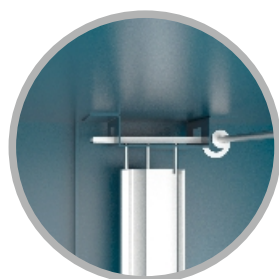

Sistema antivuelco.  
Système anti-renversement.  
Anti-roll system.

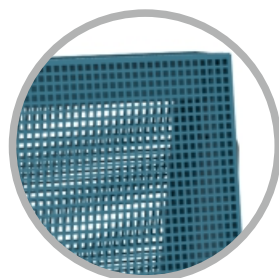

Panel perforado.  
Panneau perforé.  
Perforated panel.

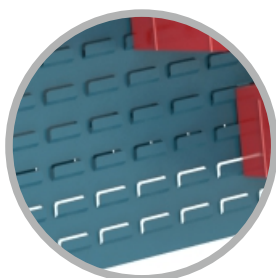

Panel porta cubetas.  
Panneau pour bacs à bec.  
Tray-holder panel.

**SERIE 128**

Carro de alta resistencia para trabajos de exteriores.  
Chariot haute résistance pour les travaux en extérieurs.  
Heavy duty workshop trolley for outdoor work.

**Ref. 128**

46 Kg

Asa y portadocumentos.  
Poignée et porte-documents.  
Handle and document holder.



Bandeja.  
Plateau.  
Shelf.

2 mm

Chapa perforada.  
Tôle perforée.  
Perforated sheet.

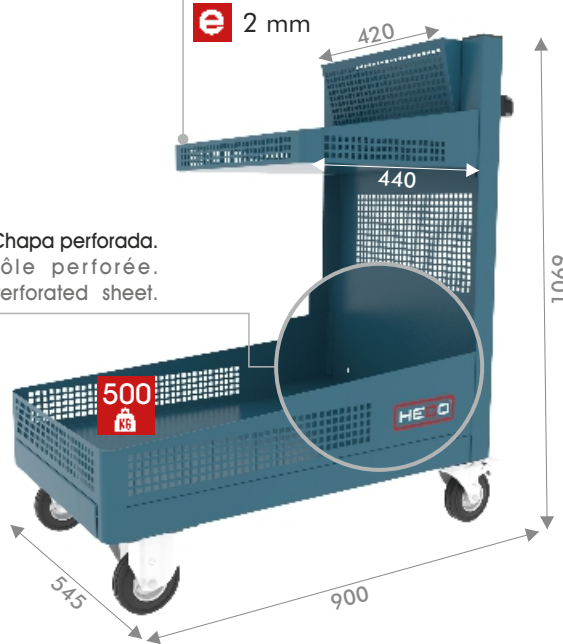

**Ref. 128 pack 1**

54 Kg

1x Ref. 138 4 SA



**Ref. 128 pack 2**

59 Kg

1x Ref. 138 4 SA

1x Ref. 102 7



Estructura y ruedas.  
Châssis et roues.  
Frame and wheels.

1,5 mm

Ø125



Consultar plazo de entrega.  
Consulter le délai de livraison.  
Check delivery time.

El candado para el arcón no se suministra.  
La serrure du coffre n'est pas fournie.  
The lock for the chest is not supplied.

**SERIE 116**

Cierre con persiana y cajones con guías ranuradas cada 14 mm.  
Fermeture a rideau et tiroirs avec glissières rainurées chaque 14 mm.  
Shutter closure and drawers with grooved slides every 14 mm.

**Ref. 116 1**

34,7 Kg

Incluye 2 bandejas fijas.  
2 plateaux fixes inclus.  
Included 2 fixed trays.

**Ref. 116 2 01**

División cajón  
Séparation tiroir  
Division drawer

Persiana ambos lados.  
Rideau deux côtés.  
Shutter both sides.

Cada cajón incluye dos divisiones.  
Chaque tiroir inclus deux séparations.  
Each drawer included two divisions.

100 Kg

240 Kg

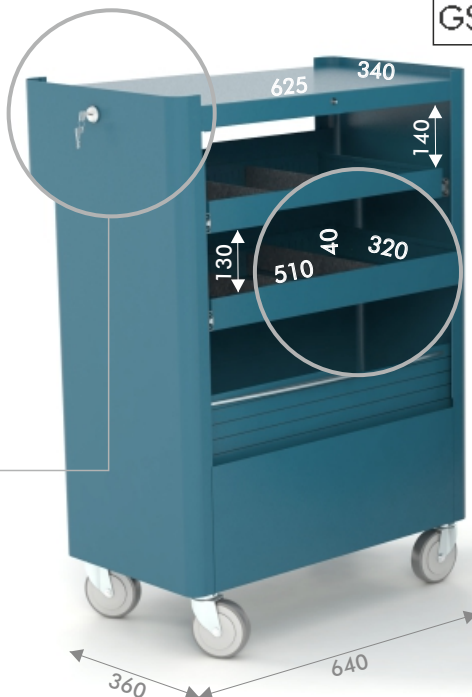

Cierre a la izquierda.  
Verrouillage à gauche.  
Left-hand locking.

1 mm

**Ref. 116 3**

42,3 Kg

Incluye 4 cajones.  
4 Tiroirs inclus.  
Included 4 drawers.

**Ref. 116 2 01**

División cajón  
Séparation tiroir  
Division drawer

Persiana un lado.  
Rideau un côté.  
Shutter one side.



Ruedas de goma  
Roues en caoutchouc  
Rubber wheels

Ø 100 mm  
H 135 mm

Cierre centralizado con llave (bloqueo persiana).  
Verrouillage centralisé avec clé (verrouillage rideau).  
Central locking with key (shutter blocking).

Carro con cajones de diferentes composiciones.  
Servante avec tiroirs de différentes compositions.  
Trolley with drawers of different compositions.

Cada cajón incluye tres divisiones.  
Chaque tiroir inclus trois séparations.  
Each drawer included three divisions.

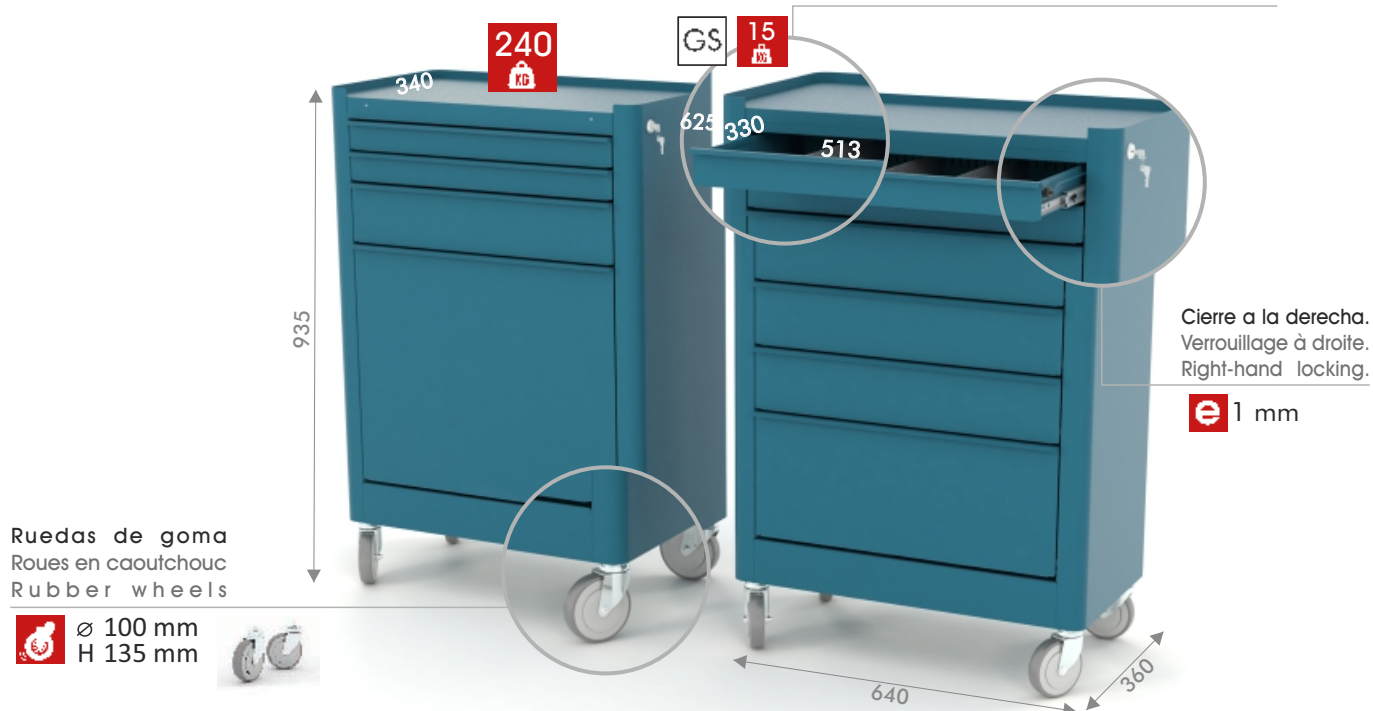

Ruedas de goma  
Roues en caoutchouc  
Rubber wheels

Ø 100 mm  
H 135 mm

### Ref. 117 0

49,8 Kg

Incluye 4 cajones.  
4 Tiroirs inclus.  
Included 4 drawers.

2x 117 S15 C55 Ref. 117 001  
1x 117 S15 C110 Ref. 117 002  
1x 117 S15 C440

Divisiones cajones  
Séparations tiroirs  
Divisions drawers



### Ref. 117 1

49,8 Kg

Incluye 5 cajones.  
5 Tiroirs inclus.  
Included 5 drawers.

2x 117 S15 C55 Ref. 117 001  
1x 117 S15 C110 Ref. 117 002  
2x 117 S15 C220 Ref. 117 003

Divisiones cajones  
Séparations tiroirs  
Divisions drawers



### Ref. 117 2

51 Kg

Incluye 6 cajones.  
6 Tiroirs inclus.  
Included 6 drawers.

2x 117 S15 C55 Ref. 117 001  
3x 117 S15 C110 Ref. 117 002  
1x 117 S15 C220 Ref. 117 003

Divisiones cajones  
Séparations tiroirs  
Divisions drawers



### Ref. 117 3

53,3 Kg

Incluye 8 cajones.  
8 Tiroirs inclus.  
Included 8 drawers.

4x 117 S15 C55 Ref. 117 001  
4x 117 S15 C110 Ref. 117 002

Divisiones cajones  
Séparations tiroirs  
Divisions drawers



**SERIE M 7**

Carro para taller de alta resistencia.  
Servante d'atelier de haute résistance.  
Heavy duty workshop trolley.

**Ref. 122 M 7**

-  170 Kg
- 3u. Ref. 122 S100 C75
- 2u. Ref. 122 S100 C100
- 1u. Ref. 122 S100 C125
- 1u. Ref. 122 S100 C150

Encimera.  
Plan de travail.  
Worktop.

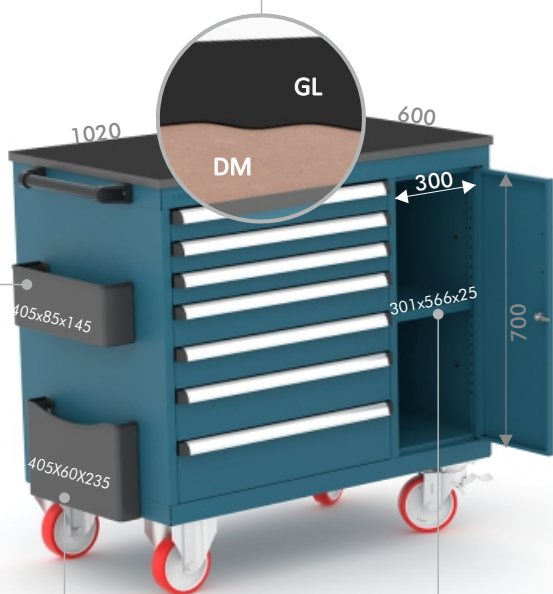

**Ref. 122 2 M 01**

Portaesprais.  
Porte-sprays.  
Sprays-holder.

**Ref. 122 2 M 02**

Portadocumentos.  
Porte-documents.  
Document-holder.

**Ref. 122 M BG**

Bandeja graduable.  
Plateau réglable.  
Adjustable tray.

Cajones.  
Tiroirs.  
Drawers.



**Ref. 135 M 7**

-  137,5 Kg
- 3u. Ref. 135 S100 C75
- 2u. Ref. 135 S100 C100
- 1u. Ref. 135 S100 C125
- 1u. Ref. 135 S100 C150

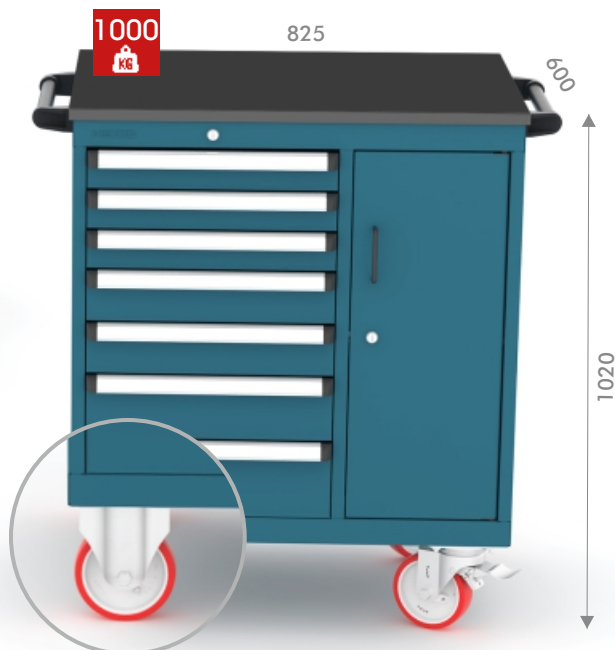

Ø 150 mm  
H 196 mm

Ruedas.  
Roues.  
Wheels.



 Cierre centralizado con llave (1 sola llave) y superficie superior antideslizante.  
Verrouillage centralisé avec clé (une unique clé) et Surface supérieure antidérapante.  
Central locking with only one key and Nonslip top surface.

 Los carros no incluyen las ref. 122 2 M 01, 122 2 M 02 ni la bandeja 122 M BG.  
Les chariots ne comprennent pas les références 122 2 M 01, 122 2 M 02 ni le plateau 122 M BG.  
The trolleys do not include ref. 122 2 M 01, 122 2 M 02 or tray 122 M BG.



 Composición estándar con 7 cajones.  
Composition standard avec 7 tiroirs.  
Standard composition with 7 drawers.

Accesorios opcionales  
Accessoires optionnels  
Optional accessories

**Ref. 149 0 01**

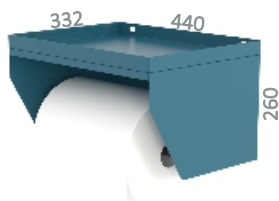
Portarollos  
Porte-rouleau  
Roll-holder





-  6 Kg
-  460 x 340 x 300 mm

**Ref. 149 0 04**

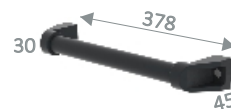
Asa  
Poignée  
Handle



-  1 Kg
-  400 x 70 x 50 mm

Carro de trabajo con cajones. Sistema antivuelco.  
Servante d'atelier avec tiroirs. Système anti-renversement.  
Workshop trolley with drawers. Anti-Roll system.

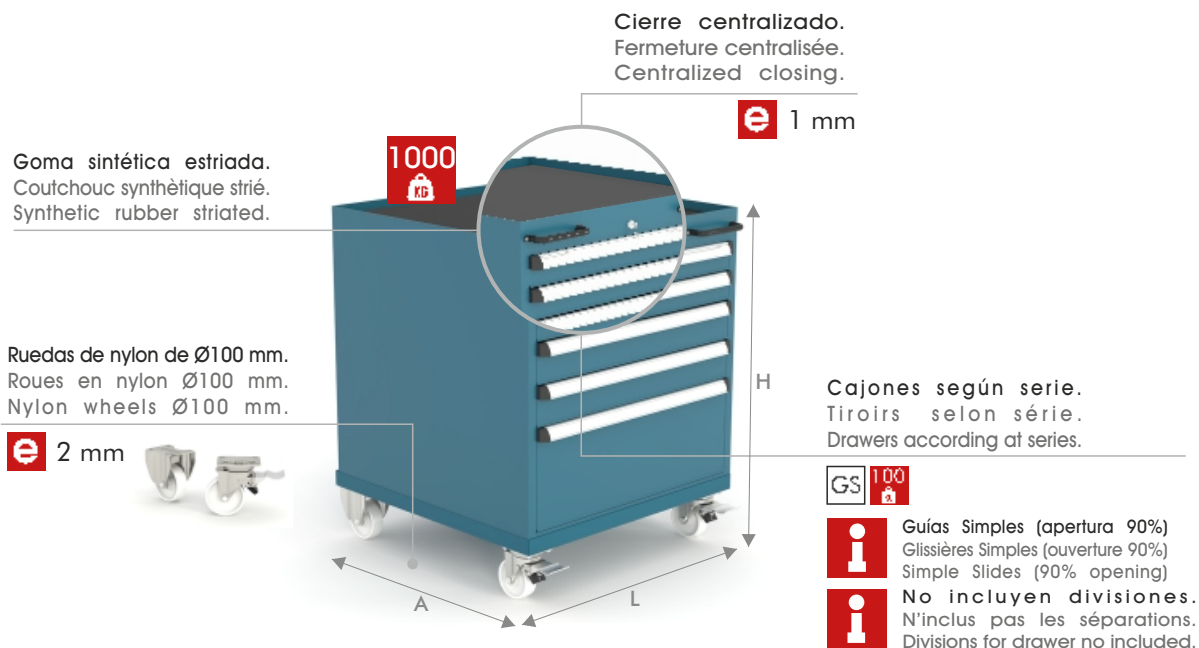

**Ref. 115 1 M**

**i** 112 Kg L 714 mm A 707 mm H 865 mm

2u. Ref. 115 S100 C75  
2u. Ref. 115 S100 C100  
1u. Ref. 115 S100 C250



**Ref. 119 1 M**

**i** 132 Kg L 1020 mm A 707 mm H 865 mm

2u. Ref. 119 S100 C75  
2u. Ref. 119 S100 C100  
1u. Ref. 119 S100 C250



**Ref. 135 0 M**

**i** 63 Kg L 515 mm A 600 mm H 790 mm

1u. Ref. 135 S100 C75  
1u. Ref. 135 S100 C100  
1u. Ref. 135 S100 C150  
1u. Ref. 135 S100 C200



**Ref. 135 1 M**

**i** 75 Kg L 515 mm A 600 mm H 865 mm

2u. Ref. 135 S100 C75  
2u. Ref. 135 S100 C100  
1u. Ref. 135 S100 C250



SERIE **151**

- RAL 7016
- RAL 3020

Carro de trabajo con cajones diferentes modelos a escoger según las necesidades.  
 Servante d'atelier avec tiroirs différents modèles à choisir en fonction des besoins.  
 Workshop trolley with drawers different versions to be chosen according to the needs.

Goma sintética estriada.  
 Coutchouc synthétique strié.  
 Synthetic rubber striated.

Cierre centralizado con llave.  
 Verrouillage central avec clé.  
 Central locking with key.

**e** 1 mm

Asa en ambos lados.  
 Poignée de chaque côté.  
 Handle on both sides.

Ruedas.  
 Roues.  
 Wheels.



Cajones sin divisiones.  
 Tiroirs sans les séparations.  
 Drawers without divisions.

**e** 0,8 mm **GT** **25**

Ref. **151 5**

- 43,97 Kg
- 1,07 m<sup>2</sup>
- 0,099 m<sup>3</sup> - 99 l

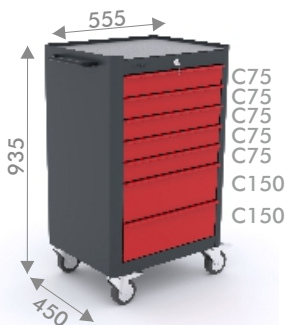

Ref. **151 6**

- 50,36 Kg
- 1,4 m<sup>2</sup>
- 0,131 m<sup>3</sup> - 131 l

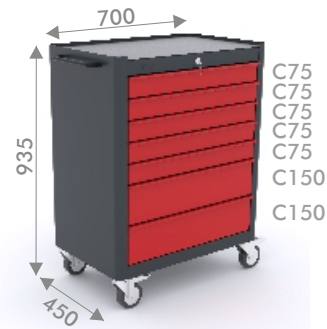

Ref. **151 7**

- 42,41 Kg
- 0,92 m<sup>2</sup>
- 0,077 m<sup>3</sup> - 77 l

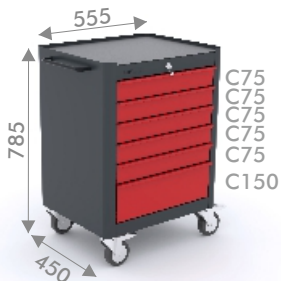

Ref. **151 8**

- 24,68 Kg  $\varnothing$  50 mm
- 0,36 m<sup>2</sup>
- 0,0314 m<sup>3</sup> - 31,4 l

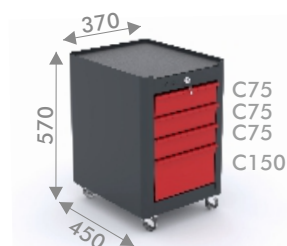

**PORTA-CONOS  
PORTE-CÔNES  
TOOL SUPPORT**

 Ref. **HSK 100**

 Ref. **HSK 80**

 Ref. **HSK 63**

 Ref. **HSK 50**

 Ref. **ISO 40**

 Ref. **ISO 50**

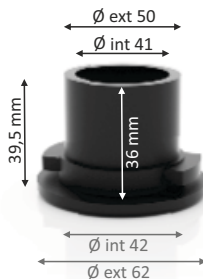
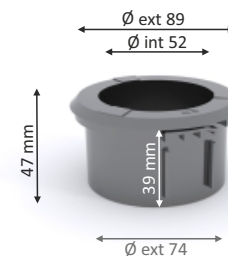
 Ref. **VDI 40**

 Ref. **CAPTO 8**

**ACCESORIOS  
ACCESSOIRES  
ACCESSORIES**

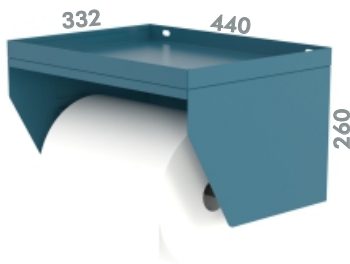
 Ref. **149 0 01**

 Portarollos  
Porte-rouleau  
Roll-holder

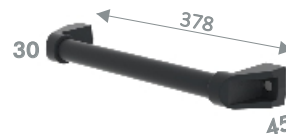
 6 Kg  
 460 x 340 x 300 mm

 Ref. **149 0 04**

 A s a  
Poignée  
Handle

 1 Kg  
 400 x 70 x 50 mm

**CUBETAS  
BACS À BEC  
T R A Y S**

 Ref. **V-BULL 1**

 2,3 Kg  
 50 u  
 0,4 L

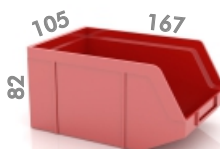
 Ref. **V-BULL 2**

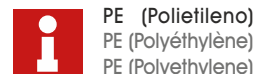
 5,3 Kg  
 48 u  
 1,2 L

 Ref. **V-BULL 3**

 8,6 Kg  
 38 u  
 3,5 L

**SOPORTES  
SUPPORTS**



Soportes para fijar en paneles perforados.  
Supports pour fixation en panneaux perforés.  
Supports for attaching to perforated panels.

**Ref. 141 0 01**

- Gancho
- Crochet
- Hook

5u. 10



**Ref. 141 0 02**

- Gancho
- Crochet
- Hook

5u. 10



**Ref. 141 0 03**

- Gancho
- Crochet
- Hook

5u. 10

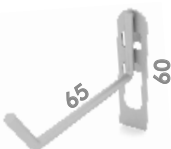

**Ref. 141 0 04**

- Gancho
- Crochet
- Hook

5u. 10

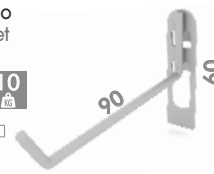

**Ref. 141 0 05**

- Gancho
- Crochet
- Hook

5u. 10



**Ref. 141 0 06**

- Gancho
- Crochet
- Hook

5u. 10



**Ref. 141 0 07**

- Gancho
- Crochet
- Hook

5u. 10

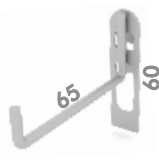

**Ref. 141 0 08**

- Gancho
- Crochet
- Hook

5u. 10

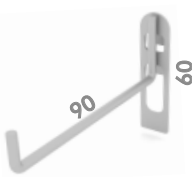

**Ref. 141 0 09**

- Bandeja
- Plateau
- Tray

1u.

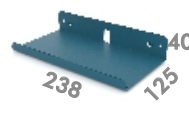

**Ref. 141 0 10**

- Llaves vaso
- Clés douille
- Socket wrenches

1u.

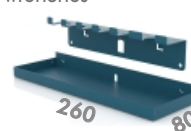

**Ref. 141 0 11**

- Cubeta con soporte
- Casier avec support
- Bucket with support

1u.

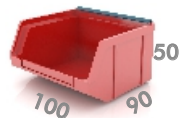

**Ref. 141 0 12**

- 6 destornilladores
- 6 tournevis
- 6 screwdrivers

1u.

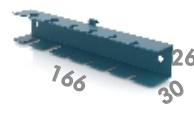

**Ref. 141 0 13**

- Bandeja
- Plateau
- Tray

1u.

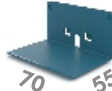

**Ref. 141 0 14**

- Alicates
- Pinces
- Pliers

1u.

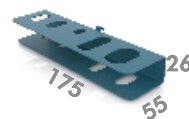

**Ref. 141 0 15**

- Tenazas
- Tenailles
- Tong

1u.

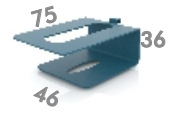

**Ref. 141 0 16**

- Tenazas apertura múltiple
- Pinces multiprises
- Multi-opening tongs

1u.



**Ref. 141 0 17**

- 12 llaves allen
- 12 clés mâle.
- 12 Allen keys

1u.

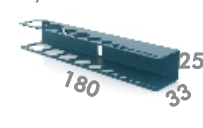

**Ref. 141 0 18**

- 12 llaves tubo
- 12 clés tube
- 12 pipe wrenches

1u.



**Ref. 141 0 19**

- 10 llaves acodadas
- 10 clés à fourches
- 10 angled keys

1u.

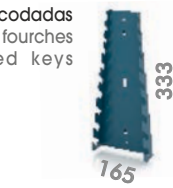

**Ref. 141 0 20**

- 12 llaves fijas
- 12 clés à fouches
- 12 fixed keys

1u.

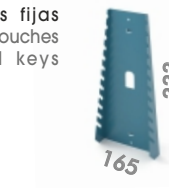

**Ref. 141 0 21**

- Blíster con 1 unidad
- Blister à 1 unité.
- 1 unit blister.

1u.



**Ref. 141 0 22**

- Blíster con 1 unidad
- Blister à 1 unité.
- 1 unit blister.

1u.

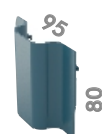

**Ref. 141 0 23**

- Blíster con 1 unidad
- Blister à 1 unité.
- 1 unit blister.

1u.



**Ref. 141 0 24**

- Llaves bujías
- Clés à bougie
- Spark plug keys

1u.



**Ref. 141 0 25**

- Maza o martillo
- Massette ou marteau
- Hammer or mallet

2u.



**Ref. 141 0 26**

- Cubeta con soporte
- Casier avec support
- Bucket with support

1u.

