

Ref. V-CONT 45  
Ref. V-CONT 50

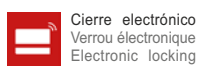

ACCESORIOS  
ACCESSOIRES  
ACCESSORIES

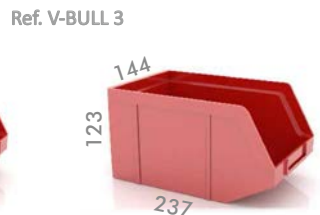

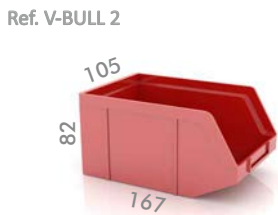
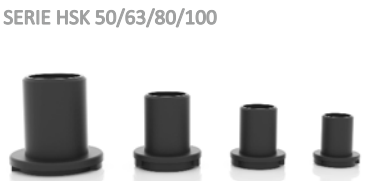

## INFORMACIÓN

INFORMATION  
INFORMATION



Cierre con llave.  
Fermeture à clé.  
Key Locking.



Interior cajón ranurado.  
Intérieur tiroir rainuré.  
Interior slotted drawer.



Sistema antivuelco.  
Système anti-renversement.  
Anti-roll system.

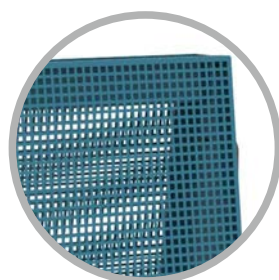

Panel perforado.  
Panneau perforé.  
Perforated panel.

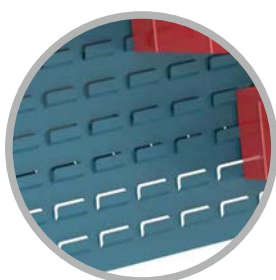

Panel porta cubetas.  
Panneau pour bacs à bec.  
Tray-holder panel.

## CARROS

### CHARIOTS

### TROLLEYS

- [ES]**
- Carros de trabajo y de taller.
  - Varias opciones de almacenaje, según necesidad.
  - Opción porta conos (ISO, CAPTO, VDI y HSK).
  - Ruedas de goma Ø75 - 100 mm (según modelo).
  - Carga máxima: 100 kg (excepto serie 134 >240 Kg).
  - Panel perforado: chapa 1,5 mm.
  - Panel porta cubetas: chapa 1,2 mm.
  - Armazón: chapa 1 mm.
  - Asa en cada lateral para facilitar el transporte.
  - Color estándar azul martelé posibilidad colores en opción.
- [FR]**
- Desserte de travail et servante d'atelier.
  - Plusieurs options de rangement selon besoin.
  - Option porte-cônes (ISO, CAPTO, VDI et HSK).
  - Roues en caoutchouc Ø75 - 100 mm (selon le modèle).
  - Charge maximale: 100 kg (sauf série 134 > 240 kg).
  - Panneaux perforés: épaisseur 15/10 mm.
  - Panneau bacs à bec: épaisseur 12/10 mm.
  - Châssis: Tôle 15/10 mm.
  - Double poignée laterale pour faciliter le transport.
  - Couleur standard bleu martelé possibilité teintes en option.
- [EN]**
- Workshop trolleys with trays for storage.
  - Several storage options according to need.
  - Optional tool-holders (ISO, CAPTO, VDI and HSK).
  - Perforated panels: 1,5 mm metal sheet.
  - Tray-holder panels: 1,2 metal sheet.
  - Frame: 1 mm metal sheet.
  - Rubber wheels, Ø75 - 100 mm (depending on model).
  - Maximum load: 100kg (except serie 134 > 240kg).
  - Handle feach for easy transport.
  - Standard colour hammered blue possibility optional colours.

## SERIE 139

Asa para una manipulación fácil.  
Poignée pour une manipulation facile.  
Handle for easy handling.

Estructura desmontable.  
Structure amovible.  
Removable structure.

**e** 2 mm



Bandejas fijas.  
Plateaux fixes.  
Fixed shelves.

**e** 1 mm

Carro con bandejas estándar.  
Desserte avec plateaux standard.  
Trolley with standard trays.

Ref. **139 2**

**KG** 18,5 Kg  
**mm** 490 x 145 x 815 mm  
**mm** Ø 75 mm  
 H 100 mm

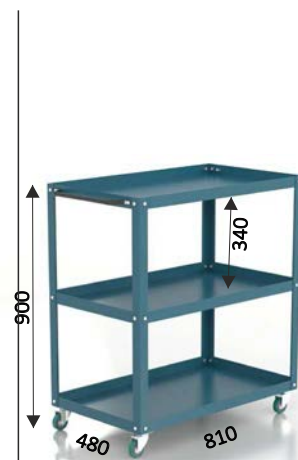

**100 KG** Carga total repartida  
Charge totale répartie  
Distributed total load

**Wrench icon** Montaje con tornillos, incluidos.  
Assemblage avec vis, inclus.  
Assembly with screws, included.

## SERIE 140

Disponible con cajón bidireccional.  
Possibilité avec tiroir bidirectionnel.  
Be able with bidirectional drawer.

Doble asa.  
Double poignée  
Double handle.



Bandejas fijas.  
Plateaux fixes.  
Fixed shelves.

**e** 0,8 mm

Estructura soldada y esquinas redondeadas.  
Structure soudée et angles arrondies.  
Welded structure and rounded edges.

**e** 3 mm

Carro de trabajo con bandejas y cajón opcional.  
Desserte de travail avec plateaux et tiroir optionnel.  
Workshop trolley with trays and optional drawer.

Ref. **140 1**

**KG** 13,8 Kg  
**mm** 660 x 380 x 850 mm  
**mm** Ø 75 mm  
 H 100 mm

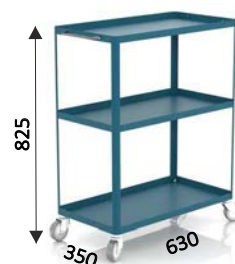

Ref. **140 2**

**KG** 16,55 Kg  
**mm** 800 x 440 x 840 mm  
**mm** Ø 75 mm  
 H 100 mm

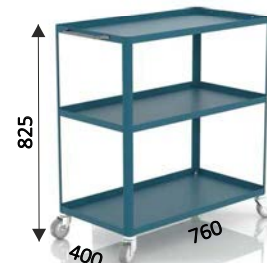

Ref. **140 3**

**KG** 16,5 Kg  
**mm** 800 x 440 x 840 mm  
**mm** Ø 75 mm  
 H 100 mm

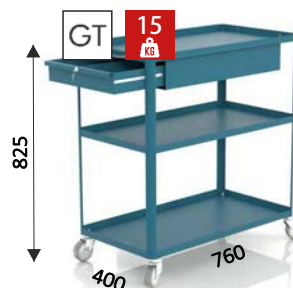

**i** cajón bidireccional  
tiroir bidirectionnel  
bidirectional drawer

**100 KG** Carga total repartida  
Charge totale répartie  
Distributed total load

## SERIE 146

Carro con bandejas y soporte porta rollo.  
Desserte avec plateaux et support de rouleau.  
Workshop trolley with trays and roll holder accessory.



Bandejas fijas.  
Plateaux fixes.  
Fixed shelves.

**e** 0,6 mm

Estructura soldada y esquinas redondeadas.  
Structure soudée et angles arrondies.  
Welded structure and rounded edges.

**e** 3 mm

## Ref. 146 1

**KG** 21,54 Kg  
805 x 430 x 1020 mm  
**W** Ø 75 mm  
H 100 mm



## Ref. 146 2

**KG** 29,29 Kg  
805 x 430 x 1020 mm  
**W** Ø 75 mm  
H 100 mm



## Ref. 108 7

**KG** 20.2 L

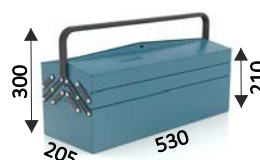

**100 KG** Carga total repartida  
Charge totale répartie  
Distributed total load

## SERIE 134

Carro de alta resistencia con bandejas o portaconos ISO/HSK/VDI/CAPTO.  
Desserte haute résistance avec plateaux ou porte-cônes HSK/ISO/VDI/CAPTO.  
Heavy duty workshop trolley with trays or tool-holders (ISO/HSK/VDI/CAPTO).



## Ref. 134 1



Bandejas portaconos.  
Plateau porte-cônes.  
Tool-holder trays.

**e** 2 mm



Estructura soldada.  
Structure soudée.  
Welded structure.

**e** 3 mm



Goma sintética estriada.  
Coutchouc synthétique strié.  
Synthetic rubber striated.

**e** 3 mm



Ruedas de goma.  
Roues en coutchouc.  
Rubber wheels.

**W** Ø100mm

SERIE **134**

 Accesorios  
 Accessoires  
 Accessories

 Ref. **134 BC**  
 bandeja - cajón  
 plateau - tiroir  
 tray - drawer

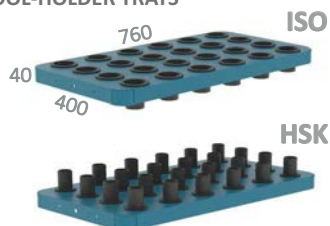

 Graduales cada 45 mm.  
 Réglables chaque 45 mm.  
 Adjustable every 45 mm.

 BANDEJAS PORTACONOS  
 PLATEAU PORTE-CÔNES  
 TOOL-HOLDER TRAYS

 PORTACONOS PORTE-CÔNES - TOOL-HOLDER  
 ISO 40/50 VDI 40

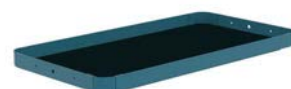

 Ref. **134 1**
 32,4 Kg

 Ref. **134 2**
 35 Kg

 Ref. **134 BG**
 6,2 Kg

 Ref. **134 BC**
 8,7 Kg

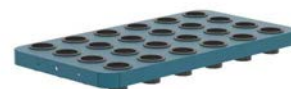
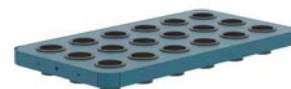
 Ref. **134 ISO 40**
 32,4 Kg  
 40x ISO 40  
**134 BG**  
**134 B ISO 40**

 Ref. **134 ISO 50**
 32,4 Kg  
 30x ISO 50  
**134 BG**  
**134 B ISO 50**

 Ref. **134 B ISO 40**
 4,6 Kg  
 24x ISO 40

 Ref. **134 B ISO 50**
 4,2 Kg  
 18x ISO 50

 Ref. **134 HSK 50**
 32,4 Kg  
 40x HSK 50  
**134 BG**  
**134 BHSK 50**

 Ref. **134 HSK 63**
 32,4 Kg  
 40x HSK 63  
**134 BG**  
**134 BHSK 63**

 Ref. **134 BHSK 50**
 4,2 Kg  
 24x HSK 50

 Ref. **134 BHSK 63**
 4,2 Kg  
 24x HSK 63

 Ref. **134 HSK 80**
 32,4 Kg  
 40x HSK 80  
**134 BG**  
**134 BHSK 80**

 Ref. **134 HSK 100**
 32,4 Kg  
 30x HSK 100  
**134 BG**  
**134 BHSK 100**

 Ref. **134 BHSK 80**
 4,2 Kg  
 24x HSK 80

 Ref. **134 BHSK 100**
 4,2 Kg  
 18x HSK 100

## SERIE 114

## Ref. 114 1

 23,94 Kg



Soportes soldados.  
Supports soudées.  
Supports welded.

Incluye cajón y bandeja fija.  
Tiroir et plateaux fixe inclus.  
Included drawer and fixed tray.

Capacidad 118 herramientas.  
Capacité 118 outils.  
Capacity 118 tools.

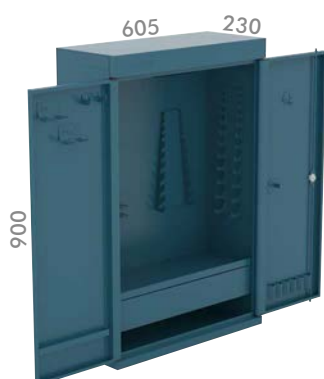

## Ref. 114 2

 25,42 Kg



Incluye cajón y bandeja fija.  
Tiroir et plateaux fixe inclus.  
Included drawer and fixed tray.

2 bandejas graduables y 1 fija.  
2 plateaux réglables et 1 fixe.  
2 regulables trays and 1 fixed.



## Ref. 114 P

 19 Kg



Soportes soldados.  
Supports soudées.  
Supports welded.

Incluye cajón y bandeja fija.  
Tiroir et plateaux fixe inclus.  
Included drawer and fixed tray.

Capacidad 118 herramientas.  
Capacité 118 outils.  
Capacity 118 tools.

Panel perforado en fondo y laterales.  
Panneau perforé en postérieur et latéraux.  
Perforated panel in front and besides.

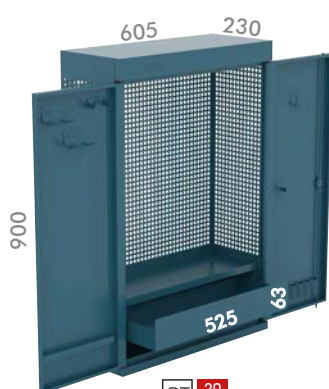

## Ref. 114 C

 21 Kg



Soportes soldados.  
Supports soudées.  
Supports welded.

Incluye cajón y bandeja fija.  
Tiroir et plateaux fixe inclus.  
Included drawer and fixed tray.

Cubetas: 10u. V-BULL 1 - 15u. V-BULL 2.  
Bacs à bec: 10u. V-BULL 1 - 15u. V-BULL 2.  
Trays: 10u. V-BULL 1 - 15u. V-BULL 2.

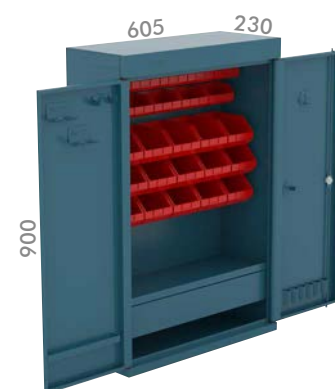

## SERIE 114 M

Componentes  
Composants  
Components

## CARRO CHARIOT / TROLLEY

## Ref. 114 M 01

 25,54 Kg

 2 mm

1x 134 BG  
bandeja graduable  
plateau réglable  
adjustable tray

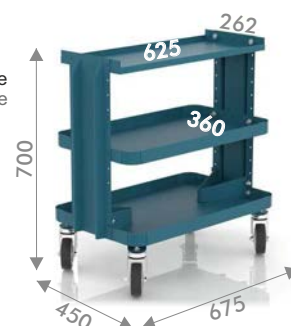

Ruedas de goma giratorias  
Roues en caoutchouc pivotant  
Rotating rubber wheels



## ARMARIO ARMOIRE / CABINET

## Ref. 114 1

 23,94 Kg

 1 mm

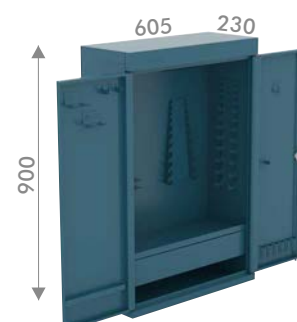

Ref. CE P 1  
Cierre electrónico  
Verrou électronique  
Electronic locking



REF. CE P 1  
REF. CE P 1 TM  
REF. CE P 1 TU

Opción  
Option  
Option

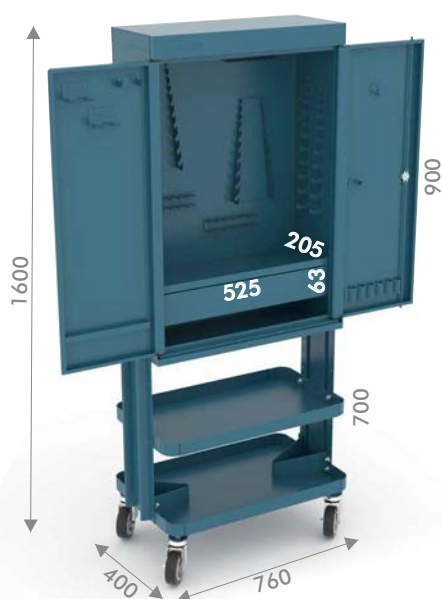

## Ref. 114 M

 49,48 Kg

114 M 01  
114 1

**PORTA-CONOS  
PORTE-CÔNES  
TOOL SUPPORT**

Ref. **HSK 100**

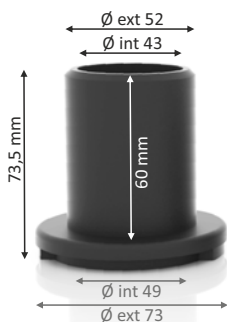

Ref. **HSK 80**

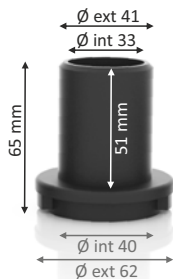

Ref. **HSK 63**

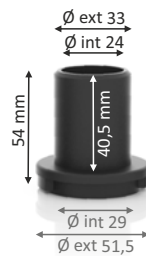

Ref. **HSK 50**

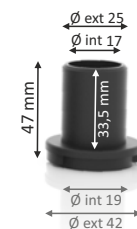

Ref. **ISO 40**



Ref. **ISO 50**



Ref. **VDI 40**

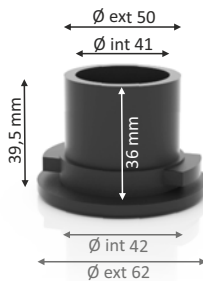

Ref. **CAPTO 8**



**ACCESORIOS  
ACCESSOIRES  
ACCESSORIES**

Ref. **149 0 01**

Portarollos  
Porte-rouleau  
Roll-holder  
6 Kg  
460 x 340 x 300 mm



Ref. **149 0 04**

A s a  
Poignée  
Handle  
1 Kg  
400 x 70 x 50 mm

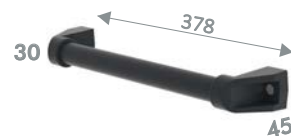

**CUBETAS  
BACS A BEC  
T R A Y S**

Ref. **V-BULL 1**

2,3 Kg  
50 u  
0,4 L



Ref. **V-BULL 2**

5,3 Kg  
48 u  
1,2 L



Ref. **V-BULL 3**

8,6 Kg  
38 u  
3,5 L

